

HIGH-FIDELITY THE EASY WAY

**RADIO &
TELEVISION
NEWS**

**JANUARY
1955**

35 CENTS
In U. S. and Canada

World's Leading Electronics Magazine

IN THIS ISSUE

**8-METER EMERGENCY
TRANSMITTER & POWER SUPPLY**

**THE MOTOROLA 19"
COLOR TV RECEIVER**

**POSITIVE VS. NEGATIVE
FEEDBACK**

SERVICING COLOR TV

ELECTRONIC BUTLER

**LOW-PASS FILTER
FROM STANDARD PARTS**

**FREQUENCY STANDARD
FOR THE NOVICE**

**BEAT-FREQUENCY AUDIO
OSCILLATOR**

**TV STUDIO
LIGHTING CONTROL**
(See page 94)

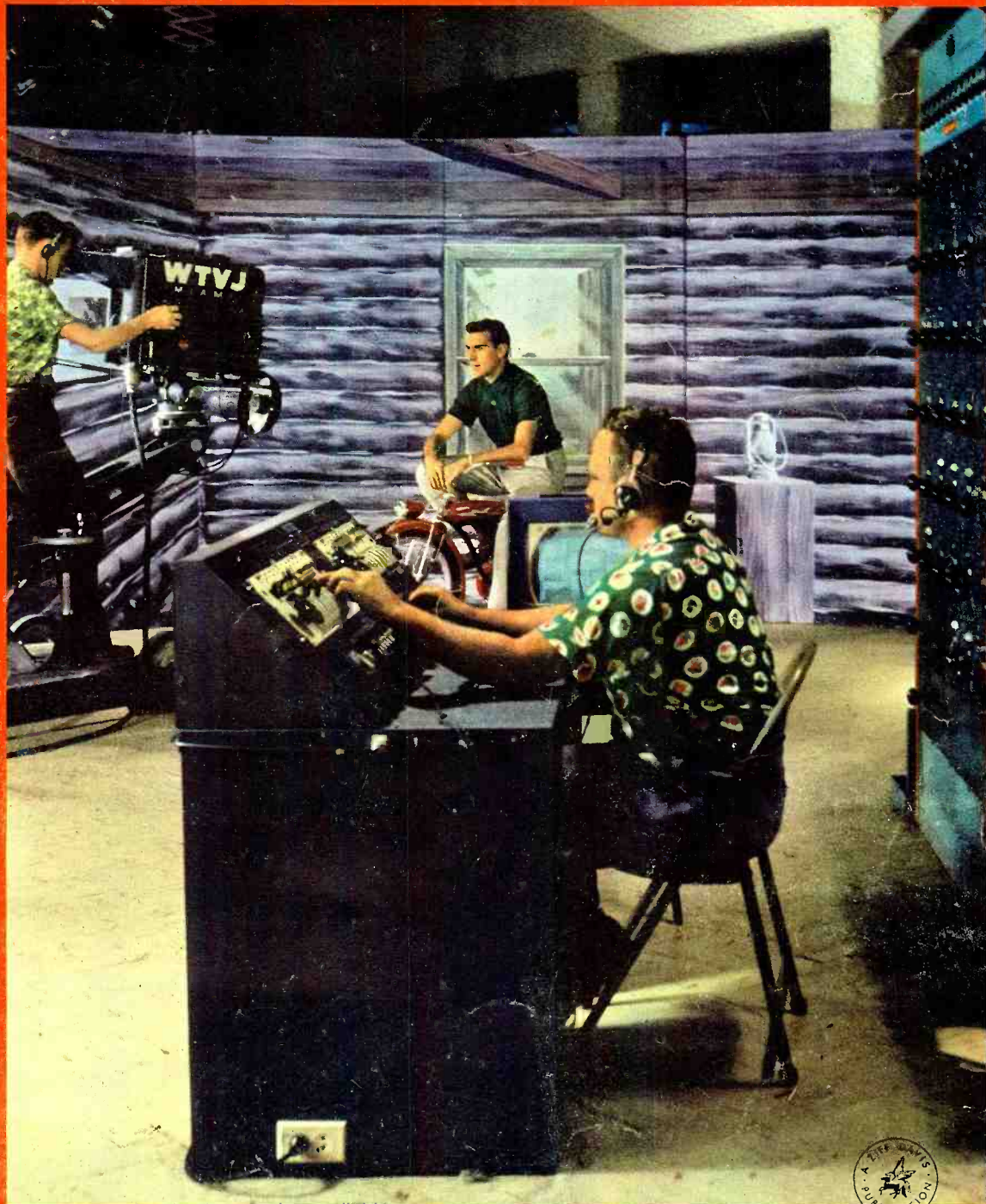



These



SERIES STRING TUBES

HAVE 300% GREATER RELIABILITY

High voltage surges due to inequalities of heater warmup time previously have limited the most effective use of "series connections" of tube heaters in TV receivers. The new Raytheon "Series String" Tubes — now used by many leading set manufacturers — virtually eliminate heater burnouts, permitting the use of this type of circuitry which results in lighter, more compact receivers.

Raytheon helped set manufacturers solve this warmup problem, by designing a new line of "Series String" Tubes which feature tightened controls on heater warmup, identical current value and a heater stability so improved that heater burnouts from warmup surges are rare. By narrowing the tolerances on heater wire to one-third of the former specifications and improving heater coating techniques this has been achieved. This important advance plus Raytheon's thorough knowledge of every aspect of tube construction guarantees the superior quality of Raytheon "Series String" Tubes.

<p>RAYTHEON 3AL5 is a heater-cathode type double diode of miniature construction. Its principal application is as a diode detector, automatic volume control rectifier, or as a low current power rectifier.</p>	<p>RAYTHEON 3AU6 is a heater-cathode type, sharp cutoff pentode of miniature construction designed for service as a high-frequency amplifier in radio and television receivers.</p>	<p>RAYTHEON 3BC5 is a heater-cathode type, sharp cutoff pentode, of miniature construction. Used as an RF amplifier and as a high-frequency, intermediate amplifier.</p>	<p>RAYTHEON 3BN6 is a 7-pin miniature, heater-cathode type, sharp cutoff pentode. Designed to perform the combined functions of limiting and frequency discrimination in FM and TV receivers.</p>	<p>RAYTHEON 3CB6 is a heater-cathode type sharp cutoff pentode of miniature construction designed for use as an intermediate frequency amplifier, operating at frequencies in the order of 40 megacycles, or as an RF amplifier in VHF Television Tuners.</p>
<p>RAYTHEON 5AM8 is a diode pentode of miniature construction designed for use as a video detector and IF amplifier in television receivers.</p>	<p>RAYTHEON 5AN8 is a medium-μ triode and a sharp cutoff pentode of miniature construction designed to perform combined functions of a video detector or IF amplifier and sync separator.</p>	<p>RAYTHEON 5J6 is a heater-cathode type, double triode of miniature construction designed for mixer applications.</p>	<p>RAYTHEON 5U8 is a heater-cathode type triode-pentode of miniature construction designed for use as an oscillator mixer.</p>	<p>RAYTHEON 6S4A is a heater-cathode type medium-μ, high-perveance triode of miniature construction for use as a vertical deflection amplifier in TV receivers.</p>
<p>RAYTHEON 6SN7GTB is a dual triode designed for use as a combined vertical oscillator and vertical deflection amplifier in television receivers.</p>	<p>RAYTHEON 7AU7 is a heater-cathode type double triode of miniature construction designed for use as a resistance coupled voltage amplifier, phase inverter, horizontal deflection oscillator or vertical deflection oscillator-amplifier in television receivers.</p>	<p>RAYTHEON 12AX4GTA is a heater-cathode type diode designed for use in Horizontal frequency damper service in television receivers.</p>	<p>RAYTHEON 12BH7A is a heater-cathode type medium-μ double triode of miniature construction designed for use as a vertical deflection amplifier in television receivers employing "Series String" heater designs.</p>	<p>RAYTHEON 12BK5 is a miniature beam power pentode designed for use as a power output tube in radio and TV receivers.</p>
<p>RAYTHEON 12BY7A is a heater-cathode type pentode of miniature construction designed for use as a video amplifier.</p>	<p>RAYTHEON 12L6GT is a heater-cathode type beam pentode power amplifier. Generally used as an output tube in ac-dc receivers.</p>	<p>RAYTHEON 12W6GT is a heater-cathode type beam pentode designed for service as a vertical deflection amplifier in TV receivers having a relatively low B supply voltage.</p>	<p>Ask your Raytheon Tube Distributor about these and other new Raytheon "Series String" Tubes.</p>	



Excellence in Electronics

RAYTHEON MANUFACTURING COMPANY

Receiving and Cathode Ray Tube Operations
Newton, Mass., Chicago, Ill., Atlanta, Ga., Los Angeles, Calif.

RAYTHEON MAKES ALL THESE:

RECEIVING AND PICTURE TUBES • RELIABLE SUBMINIATURE AND MINIATURE TUBES • SEMICONDUCTOR DIODES AND TRANSISTORS • NUCLEONIC TUBES • MICROWAVE TUBES

Here's a NEW Way to Reach the Top in TV SERVICING

**All-practice method—
professional techniques,
skills, knowledge of
circuits, etc.**



Includes 17" picture tube, all other tubes, components for a TV Receiver, Scope, Signal Generator, HF Probe. Low Introductory price under \$200, on easy terms. Mail Coupon today.

IF YOU HAVE some Radio or Television experience, or if you know basic Radio-Television principles but lack experience—NRI's new Professional Television Servicing course can train you to go places in TV servicing. This advertisement is your personal invitation to get a free copy of our booklet which describes this training in detail.

LEARN-BY-DOING "ALL THE WAY"

This is 100% learn-by-doing, practical training. We supply all the components, all tubes, including a 17-inch picture tube, and comprehensive manuals covering a thoroughly planned program of practice. You learn how experts diagnose TV receiver defects quickly. You see how various defects affect the performance of a TV receiver—picture and sound; learn to know the causes of defects, accurately, easily, and how to fix them. You do more than just build circuits. You get practice recognizing, isolating, and fixing innumerable TV receiver troubles.

You get actual experience aligning TV receivers, diagnosing the causes of complaints from scope patterns, eliminating interference, using germanium crystals to rectify the TV picture signal, obtaining maximum brightness and definition by properly adjusting the ion trap and centering magnets, etc. There isn't room on this or even several pages of this magazine to list all the servicing experience you get.

UHF AND COLOR TV MAKING NEW BOOM
Installing front-end channel selector strips in modern UHF-VHF Television receivers and learning UHF servicing problems and their solution is part of the practice you get if you live in a UHF area. To cash in on the coming color TV boom you'll need the kind of knowledge and experience which this training gives.

GET DETAILS OF NEW COURSE FREE

Once again—if you want to go places in TV servicing, we invite you to find out what you get, what you practice, what you learn from NRI's new course in Professional Television Servicing. See pictures of equipment supplied, read what you practice. Judge for yourself whether this training will further your ambition to reach the top in TV servicing. We believe it will. We believe many of tomorrow's top TV servicemen will be graduates of this training. Mailing the coupon involves no obligation.



**National Radio Institute, Dept. 5AET
16th and U Sts., N.W., Washington 9, D. C.**

Please send my FREE copy of "How to Reach the Top in TV Servicing." I understand no salesman will call.

Name _____ Age _____

Address _____

City _____ Zone _____ State _____

RADIO & TELEVISION NEWS is published monthly by Ziff-Davis Publishing Company, William B. Ziff, Chairman of the Board (1946-1953), at 64 E. Lake St., Chicago 1, Ill. Entered as second-class matter July 21, 1948, at the Post Office, Chicago, Ill., under the act of March 3, 1879. Authorized by Post Office Department, Ottawa, Canada, as second-class matter. SUBSCRIPTION RATES: Radio & Television News—one year U. S. and possessions, and Canada \$4.00; Pan-American Union countries \$4.50; all other foreign countries \$5.00. Radio-Electronic Engineering Edition—One year U. S. and possessions, and Canada \$6.00; Pan-American Union countries \$6.50; all other foreign countries \$7.00. Postmaster—Please return undelivered copies under form 3589 to 64 E. Lake St., Chicago 1, Ill.

Editor and Asst. Publisher
OLIVER READ, D.Sc., W1ETI

Managing Editor
WM. A. STOCKLIN, B. S.

Technical Editor
H. S. RENNE, M. S.

Service Editor
CHARLES TEPFER

Assistant Editors
P. B. HOEFER
M. C. MAGNA

Television Consultant
WALTER H. BUCHSBAUM

Short-Wave Editor
KENNETH R. BOORD

Art Editor
FRANK SAYLES

Draftsmen
A. A. GANS, W2TSP
J. A. GOLANEK

Advertising Director
L. L. OSTEN

Advertising Manager
MURRAY GOLDMAN

Midwest Adv. Manager
JOHN A. RONAN, JR.

Western Adv. Manager
JOHN E. PAYNE



*First in radio-
television-audio-electronics*

Average Net Paid Circulation 246,119

Radio News Trademark Reg. U. S. Pat. Office • Television News Trademark Reg. U. S. Pat. Office.

Reg. U. S. Pat. Off.
U. S. Pat. Office.

CONTENTS

JANUARY, 1955

Six-Meter Emergency Transmitter and Power Supply.....
.....Maurice P. Johnson, W3TRR & Robert L. Hankey, W3OBC 37

A Cascode Television Booster.....Hardin G. Stratman 41

Build Your Own Color TV Converter (Part 2).....Jay Stanley 42

What Price Crossover?.....Charles E. Diehl 44

Servicing Color TV (Part 1).....Milton S. Kiver 45

Electronic Butler.....Jay J. Lucas 48

High-Fidelity the Easy Way.....Comdr. W. B. Bernard, USN 50

A New Pocket Radio.....54

Frequency Standard for the Novice.....Robert J. Ropes, W9PAP 55

Combining Positive and Negative Feedback in an Audio Amplifier.....
.....David Fidelman 56

V.T.V.M. Measures Capacity.....C. F. Pocius 59

A Low-Pass Filter from Standard Parts.....Neil A. Johnson, W2OLU 60

What's New in TV Deflection Circuits.....John K. Frieborn 62

TV Repair in England.....John D. Burke 64

The Motorola 19" Color TV Receiver (Part 1).....M. S. Kay 66

Certified Record Revue.....Bert Whyte 70

A Beat-Frequency Audio Oscillator.....Robert G. Vaughn, Jr. 71

TV Flyback and Yoke Checker.....Jack Freeman 74

Mac's Radio Service Shop.....John T. Frye 76

TV Studio Lighting Control.....94

A Conelrad Monitor.....L. David Oliphant 99

Replacing TV Parts.....Art Margolis 120

New TV Grants Since Freeze Lift.....134

New TV Stations on the Air.....134

Radio-TV Service Industry News.....144

DEPARTMENTS

For the Record.....The Editor	8	Technical Books	109
Spot Radio News.....	16	What's New in Radio.....	122
Within the Industry.....	24	Manufacturers' Literature	150
Short-Wave.....K. R. Boord	78	New Audio Equipment.....	166

COPYRIGHT 1954

(All Rights Reserved)

ZIFF-DAVIS PUBLISHING COMPANY
WILLIAM B. ZIFF (1898-1953) FOUNDER
Editorial and Executive Offices
366 Madison Ave., New York 17, N. Y.
VOLUME 53 • NUMBER 1



Member
Audit Bureau of
Circulations



SUBSCRIPTION SERVICE: All communications concerning subscriptions should be addressed to Circulation Dept., 64 E. Lake St., Chicago 1, Ill. Subscribers should allow at least four weeks for change of address.

CONTRIBUTIONS: Contributors are advised to retain a copy of their manuscripts and illustrations. Contributions should be mailed to the New York Editorial Office and must be accompanied by return postage. Contributions will be handled with reasonable care, but this magazine assumes no responsibility for their safety. Any copy accepted is subject to whatever adaptations and revisions are necessary to meet the requirements of this publication. Payment covers all author's, contributor's, and contestant's rights, title, and interest in and to the material accepted and will be made at our current rates upon acceptance. All photos and drawings will be considered as part of the material purchased.

RADIO & TELEVISION NEWS

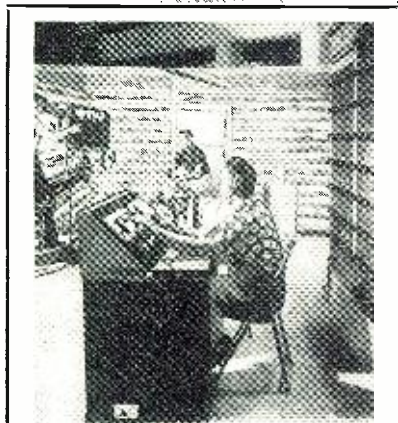

COVER PHOTO: Good lighting is a most important feature of a TV show. Today, most studios use some kind of electronic control. Featured here is the lighting-control equipment for TV station WTVJ, Miami, Florida. (Ektachrome by Mike Mancini)

ZIFF-DAVIS PUBLISHING COMPANY

President

B. G. DAVIS

Vice-Presidents

H. J. MORGANROTH

M. H. FROELICH

Secretary-Treasurer

G. E. CARNEY

Circulation Manager

M. MICHAELSON

BRANCH OFFICES

CHICAGO (NY)

64 E. Lake St., AN 1-5200

LOS ANGELES 114:

Starliner Center, 900 Wilshire Blvd., MI 6-9556

In Spare Time at Home—Prepare for a Better Job—
or Your Own Business in

TELEVISION

RADIO • ELECTRONICS



You build and keep this valuable Jewel Bearing MULTI-METER.

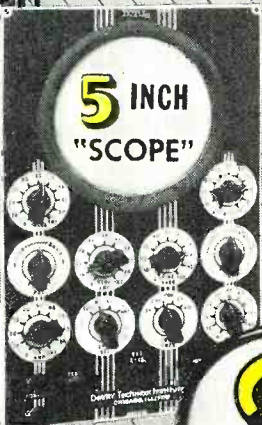

You also build and keep this high quality 5 INCH oscilloscope—almost a "must" for Television servicing.

If the man who is seeking a better job or a business of his own will take time to compare all the opportunities available to him today, he will undoubtedly consider a career in Television-Radio-Electronics.

A bird's eye view of the tremendous opportunities that exist in this fast-growing American industry reveals that hundreds of TV stations are yet to be built, millions of sets to be manufactured, and other millions of existing sets to be serviced from time to time.

Another marked advantage for men 17 to 45 is the fact that they can prepare to enter these profitable fields in their spare time at home or in our modern laboratory in Chicago. Another distinct advantage is the fact that no previous technical experience or advanced education is required.

After a man completes his training at home or in our Chicago Laboratory, he may get the benefit of our effective EMPLOYMENT SERVICE to help him get started.

Again we say—compare these opportunities and advantages. Send for full facts today. Mail coupon below NOW!



Build and keep this BIG DTI Engineered TV set—easily converted to U.H.F. (DTI offers another home training, but without the TV set.)

COLOR TELEVISION

D.T.I.'s program also includes training in Color Television

EMPLOYMENT SERVICE

Upon completing either the Chicago Laboratory or Home Training, DTI's long-established, effective Employment Service is ready to help you start earning real money. Get full facts. Mail coupon today.

MODERN LABORATORY

If preferred, you can get all of your preparation in our modern Chicago Training Laboratory—one of the finest of its kind. Ample instructors, modern equipment. Write for details!

WORK OVER 300 PROJECTS

You set up your own HOME LABORATORY . . . work with and keep the same type of basic electronic parts used in D.T.I.'s modern Chicago Training Center. Now you can get real Laboratory-type training—AT HOME.

"One of America's Foremost Television Training Centers"



89 WAYS TO EARN MONEY IN TELEVISION RADIO-ELECTRONICS

MILITARY SERVICE!

If you're subject to military service, the information we have for you should prove very helpful. Mail coupon today.

16-mm. HOME MOVIES



You use this 16-mm. motion picture projector and many reels of educational film—a wonderful, exclusive, D.T.I. home aid to help you understand important fundamentals faster . . . easier . . . better. It's almost like having a teacher in your home.

ACT NOW!

Get information packed publication FREE!!
Mail Coupon Today.

DEVRY TECHNICAL INSTITUTE

4141 Belmont Ave., Chicago 41, Ill. Dept. RN-1-L

I would like the facts, including your valuable information-packed publication showing how I may get started toward a good job or my own business in Television-Radio-Electronics.

Name _____ Age _____
Street _____ Apt. _____
City _____ Zone _____ State _____

D.T.I.'s Training is available in Canada



DEVRY TECHNICAL INSTITUTE

AFFILIATED WITH

DEFOREST'S TRAINING, INC.
CHICAGO 41, ILLINOIS

"Everywhere! Even in the most extreme fringe areas, the sensational Winegard Interceptors are providing clear, enjoyable TV pictures."

Wilmington, Del.
 "First shipment of Interceptors and Pixies enthusiastically acclaimed by our dealers. Advertising claims well founded. Pixie will outperform a stacked conical . . . oftentimes at a much lower height. Interceptor better than anything we have run up against including large colinear arrays."
DELAWARE ELECTRONICS SUPPLY CO.

Reports like these from across the nation are pouring in, testifying to the exceptional performance of our antennas

A great new antenna that gives you both

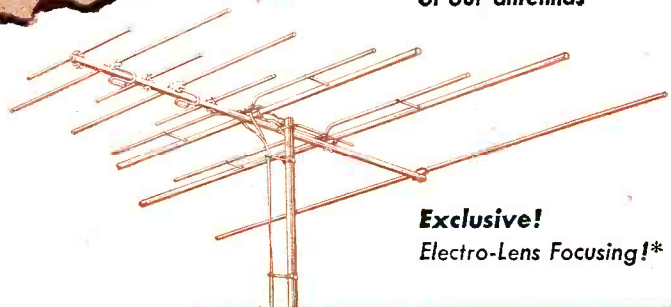

Exclusive!
 Electro-Lens Focusing!*

1. Complete all-channel VHF coverage—
2. Brilliant yagi performance—
 Yes, the extraordinary high gain of a yagi . . .
 The pin-point directivity of a yagi . . .
 Not on just one channel—not on just one band
 —but clear across the whole VHF spectrum.

The Interceptor is designed for both black and white and color

The same Interceptor that gives you those sharp, clear black and white pictures today will give you the truest, brightest color pictures imaginable in the future.

NOTE—The Interceptor has been received so enthusiastically . . . all over the country . . . that the Winegard Company, even with around the clock production in its brand new plant, can't seem to make *Interceptors* fast enough. Twice this season production has been actually doubled over what was originally planned, and still we are experiencing difficulty in keeping up with this tremendous demand. So, get your order in now—and avoid disappointment on delivery.

List price U.S.A. . . . Interceptor . . . per bay . . . **\$24⁹⁵**
 (Stacking bars available)

AND NOW up to 22% more gain! Super 'Ceptor
 (Super Interceptor)

A NEW more powerful version of our famous Winegard Interceptor—Now—makes it possible to have multi-element yagi performance on all channels in the most extreme fringe areas.

The Super 'Ceptor possesses all of the wonderful features of the Interceptor, but with much increased sensitivity . . . **up to 22% more gain** over the standard Interceptor model.

Features of the Interceptor and Super 'Ceptor

- Excellent 300 ohm impedance match over the entire VHF range.
- Extremely narrow yagi type forward lobes, with no side lobes and negligible rear lobes.
- Single lead . . . no switching . . . no interaction between the high channel elements and the low band elements.

The New Winegard Super 'Ceptor
 (Super Interceptor)
 With Electro-Lens Focusing!*

Gives you—multi-element yagi performance, not on one channel . . . not on one band . . . but on every single channel in the whole VHF spectrum!

List price U.S.A. . . . Super 'Ceptor . . . per bay **\$34⁹⁵**
 (Stacking bars available)

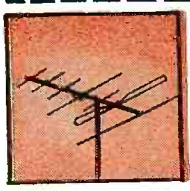
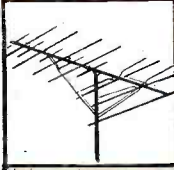

IMP—Model L-7 for channels 7-13. On the high VHF band, the IMP functions as two high gain yagi—operating side by side in perfect phase, to give gain and directivity far in excess of more conventional 7-13 broad band designs.

Imp Features:

- Exceptionally high gain on channels 7-13.
- Full wave driven elements.
- Full wave reflector elements.
- Electro-Lens Focusing.*

Note—the IMP makes the perfect all-channel attic antenna for *all* channels in primary areas.

List price U.S.A. . . . Imp . . . per bay . . . **\$12⁹⁵**
 (Stacking bars available)

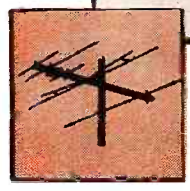

THE PIXIE

Top all channel performance—at a low price—featuring unique improved conical type driven element—for high gain and uni-lobe directivity.

List price U.S.A. . . . PIXIE . . . per bay **\$14⁹⁵**
 (Stacking bars available)

*PATENT PENDING

See your jobber or write us for additional information about the Interceptor and other Winegard antennas



WINEGARD COMPANY

3000 SCOTTEN BOULEVARD, BURLINGTON, IOWA

Winegard—America's most wanted line of TV antennas—designed to make installations quicker—easier—and more profitable

RADIO & TELEVISION NEWS

HIGH-FIDELITY MUSIC-APPRECIATION RECORDS

TO HELP YOU UNDERSTAND MUSIC BETTER AND ENJOY IT MORE



ON ONE SIDE there is a full performance of a great musical work, featuring orchestras and soloists of recognized distinction in this country and abroad. You listen to this performance first, or afterward, as you desire, and then . . .



ON THE OTHER SIDE is an illuminating analysis of the music, with the themes and other main features of the work played separately with running explanatory comment, so that you can learn *what to listen for*.

A NEW IDEA OF THE BOOK-OF-THE-MONTH CLUB

ALL TOO FREQUENTLY, most of us are aware, we do not listen to good music with due understanding and appreciation. There is no doubt about the reason: we are not properly primed about *what to listen for*. MUSIC-APPRECIATION RECORDS meet this need—for a fuller understanding of music—better than any means ever devised. After hearing several of these records, all the music you listen to is transformed, because you learn in general what to listen for. This highly enjoyable form of self-education can be as thorough as the Music-Appreciation courses given in any university.

YOU SUBSCRIBE BUT TAKE ONLY THE RECORDS YOU WANT . . . A new MUSIC-APPRECIATION RECORD will be issued—for subscribers only—every month. Ultimately

all the great masterpieces of music will be included. The announcement about each forthcoming record will be written by Deems Taylor. After reading this descriptive essay (presented in a form that can be kept for long use) you may take the record or not, as you decide at the time. *You are not obligated as a subscriber to take any specified number of records.* And, of course, you may stop the subscription at your pleasure—at any time!

TWO TYPES OF RECORDS AT A RELATIVELY LOW COST . . . All MUSIC-APPRECIATION RECORDS will be high-fidelity, long-playing records of the highest quality—33 $\frac{1}{3}$ R.P.M. on Vinylite. They will be of two kinds: first, a so-called Standard Record—a *twelve-inch* disc—which will present the performance on one side, the analysis

on the other. This will be sold at \$3.60, to subscribers only. The other will be an Analysis-Only Record—a *ten-inch* disc—priced at \$2.40. The latter will be made available each month for any subscriber who may already have a satisfactory long-playing record of the work being presented. (A small charge will be added to the prices above to cover postage and handling.)

TRY A ONE-MONTH SUBSCRIPTION — NO OBLIGATION TO CONTINUE . . .

Why not make a simple trial, to see if these records are as pleasurable and as enlightening as you may anticipate? The first record, BEETHOVEN'S FIFTH SYMPHONY, will be sent to you at once—at *no charge*. You may end the subscription immediately after hearing this record, or you may cancel any time thereafter.

As a demonstration
**WILL YOU ACCEPT
WITHOUT CHARGE**



Beethoven's Fifth Symphony

A NEW HIGH-FIDELITY RECORDING BY THE LONDON SYMPHONY ORCHESTRA

Norman Del Mar, Conductor

Analysis by Thomas Scherman

YOU HAVE HEARD this great work countless times—what have you heard in it? And what may you have failed to hear? This demonstration will show you what you may have been missing in listening to great music.

PLEASE RETURN ONLY IF YOU HAVE A RECORD PLAYER WHICH CAN PLAY 33 $\frac{1}{3}$ R.P.M. LONG-PLAYING RECORDS

MUSIC-APPRECIATION RECORDS
c/o Book-of-the-Month Club, Inc.
345 Hudson Street, New York 14, N. Y.

R38-1

Please send me at once the first MUSIC-APPRECIATION RECORD, *Beethoven's Fifth Symphony*, without charge, and enter my name in a Trial Subscription to MUSIC-APPRECIATION RECORDS, under the conditions stated above. It is understood that, as a subscriber, I am not obligated to buy any specified number of records, but may take only those I want. Also, I may cancel this subscription after hearing the first record, or any time thereafter at my pleasure, but the introductory record is free in any case.

Mr. }
Mrs. }
Miss } (Please Print)
Address
City..... Zone..... State.....

MAR 1

Thrill to
"silk-and-diamond"
highs*

12 NOTES
ABOVE
HIGH C,
AND UP

E-V
T 35 Super Sonax

*Smooth as silk, brilliant as diamonds, the highest octaves you can hear are realistically yours, with an E-V T35 in your high fidelity music installation. This new, very-high-frequency tweeter takes over from 3500 cps to beyond audibility . . . provides 180° dispersion. Is easily installed, along with recommended X36 crossover and AT37 level control.

T35	List \$55.00	Audiophile Net	\$33.00
T35B	List \$35.00	Audiophile Net	\$21.00
X36	List \$14.00	Audiophile Net	\$ 8.40
AT37	List \$ 6.00	Audiophile Net	\$ 3.60

The T35B— for lower powered systems and existing quality AM-FM radio or radio-phonographs, finished in flat matte black. Requires only X36 to attach to music system. Impedance 16 ohms. Shipping weight 2 lbs.

Beautiful T35 Accessory Enclosure

The Piccolino for either the T35 or the T35B. Styled in gleaming tropical mahogany or lustrous Korina blonde. List \$15.00. Audiophile net \$9.00.

The Piccolino, complete with Super-Sonax, X36 crossover and AT37 level control wired and ready to connect to your music system: with T35 List \$90.00. Audiophile Net \$54.00; with T35B List \$70.00. Audiophile Net \$42.00.

Prove the performance of the T35 to yourself!

You hear the difference with this T35 demonstrator. With a flip of the switch you bring in or cut out the T35. Visit your E-V distributor to conduct this amazing test personally.

Today—write for Bulletin 194 and where to buy.

Electro-Voice ELECTRO-VOICE, INC.
BUCHANAN, MICHIGAN

For the RECORD.

BY THE EDITOR

ANOTHER NEW YEAR

ENTERING our 36th year of uninterrupted publishing of RADIO & TELEVISION NEWS, we look ahead to the wide-spread acceptance by the public of color television. Color TV got its "feet wet" during 1954, and the networks have stepped up their color programming considerably. As we see it, the only real obstacle in the path is the cost of the color set. As competition increases, it is now conceivable that mass production will result in price tags for color receivers of less than \$500.00 before the year's end.

The introduction of large-screen color pictures has done little to provide additional spark on the part of the public. The average prospect still looks upon color TV as a luxury, and will continue to do so until prices tumble to levels within reach of the home budget.

The transistor, widely heralded during 1953, did not make the expected progress during 1954. While techniques of manufacture were improved and the cost reduced for units, there still was not wide-spread enthusiasm for all-transistor equipment. Only one commercial all-transistor radio, for example, made its appearance just a few weeks past, while at the beginning of the year it was estimated that such sets would be commonplace.

High-fidelity continued to catch the fancy of the public, and audio fairs enjoyed record attendance. In spite of the efforts of industry leaders and the trade press to properly define hi-fi, the public still is much confused as to what hi-fi actually means with respect to components.

Radio and TV servicing was more than ever big business during the year. According to RCA executive vice-president, Charles M. Odorizzi, the maintenance of home TV and radio reached 1.4 billion dollars during the year, and he expects that the annual gross will be about 2.7 billion by 1957. He also predicted that the industry, now having 100,000 technicians, will expand to more than 125,000 in 1957. He also revealed that the RCA Service Company presently employs some 5000 service technicians!

And with pardonable pride we point to the successful introduction of our sister publication, POPULAR ELECTRONICS, that has now been firmly established and circulation-wise has attained a monthly readership of a quarter-million, and continues to grow at a steady rate. One thing is certain—the tremendous interest in electronic subjects

apparently is without limitation. This is good, and points to a healthy progress for this fastest-growing industry of our times.

Controversy on "pay-as-you-look" television again comes to life as the FCC studies the comments from interested parties and services. Subscription TV has been promoted since 1947. Our readers will recall the Zenith system, called "Phonevision," described in this magazine which originally transmitted a garbled signal and which was unscrambled at the receiver by means of a special decoding device tied in with the telephone lines. The customer, as proposed, would be billed each month by the phone company. Later, other techniques of billing and decoding were suggested.

Another system, called Skiatron, employed a punch-card decoding and billing method. This card could be bought by the TV viewer and, when inserted into the decoder, would steady the garbled picture. This system was commonly called "Subscriber-Vision."

The other system, developed by International Telemeter Inc., has been studied on the West Coast at Palm Springs. It is called "Telemeter" and employs a cash box fastened to the TV set. Its action is like familiar coin-operated machines which can receive nickels, dimes, quarters, or fifty cent pieces. Upon receiving a coin, the decoder would unscramble the video for various time lengths—depending upon the amounts received.

During the course of development of these systems much opposition has come from the broadcast industry and from the motion picture exhibitors. And, a movement has been under way to amend the Communications Act to make a common carrier service for "pay-as-you-look" television.

Theater owners are still fearful of subscription TV and its potential impact on attendance. A committee representing the Theatre Owners of America has been recently organized to present a united stand against giving the "go ahead" to any pay-TV system.

Many now feel that the FCC may finally approve one or more "pay-as-you-look" systems in the not too far distant future. Then we'd like a "pay-as-you-hear" hi-fi program service for the benefit of the thousands of owners of tape recorders who would cherish tapes (off the air recordings) of a live FM symphony concert for their own libraries. . . . O.R.

FREE

1955 ALLIED 308-PAGE CATALOG

the only COMPLETE catalog
for everything in TV, Radio
and Industrial Electronics

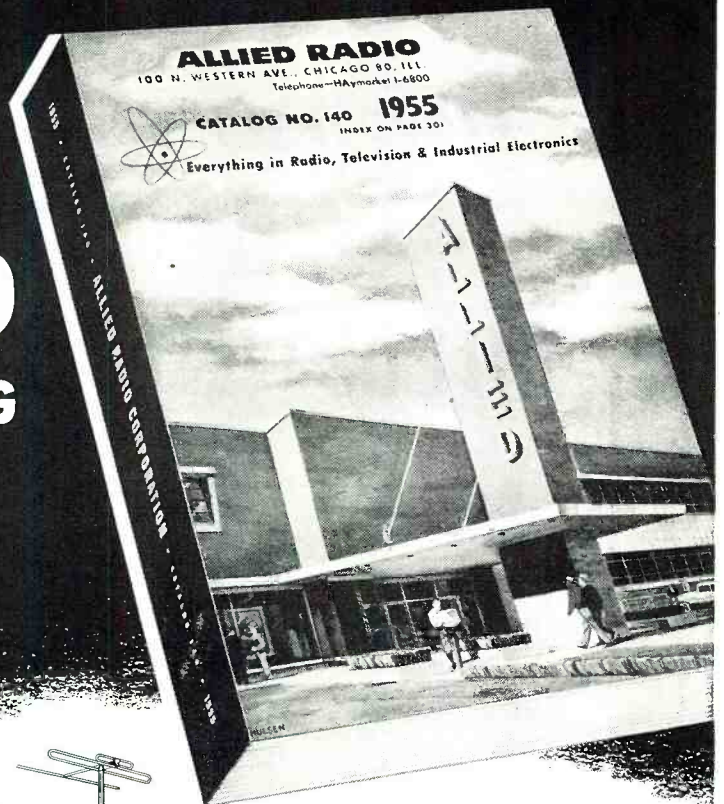

World's largest Stocks

- All TV and Radio Parts
- All Electron Tube Types
- Test and Lab Instruments
- High Fidelity Equipment
- Custom TV Chassis
- AM, FM Receiving Equipment
- Recorders and Supplies
- P.A. Systems, Accessories
- Amateur Station Gear
- Builders' Kits, Supplies
- Equipment for Industry



ultra-modern facilities for the
FASTEST SERVICE IN ELECTRONIC SUPPLY

SEND FOR IT TODAY!

Get ALLIED's 1955 Catalog—308 pages packed with the world's largest selection of quality electronic equipment at lowest, money-saving prices. Select from the latest in High Fidelity systems and components; custom TV chassis, TV antennas and accessories; AM and FM receiving equipment; P. A. systems and accessories; recorders and supplies; Amateur receivers, transmitters and station gear; specialized industrial electronic equipment; test instruments; builders' kits; huge listings of parts, tubes, tools, books—the world's *most complete* stocks of quality equipment. ALLIED gives you *every* buying advantage: fastest shipment, expert personal help, lowest prices, assured satisfaction. Get the big 1955 ALLIED Catalog. Keep it handy. Send for your FREE copy today.

IT'S VALUE PACKED... SAVE ON EVERYTHING IN ELECTRONICS

**SEND FOR THE LEADING
ELECTRONIC SUPPLY GUIDE**

FREE



ALLIED RADIO
world's largest Electronic Supply House

EASY-PAY TERMS

Use ALLIED'S liberal Easy Payment Plan—only 10% down, 12 months to pay—no carrying charges if you pay in 60 days. Available on Hi-Fi and P.A. units, recorders, TV chassis, test instruments, Amateur gear, etc.

HI-FI SPECIALISTS

To keep up with the latest and best in High Fidelity, look to ALLIED. Count on us for *all* the latest releases and largest stocks of Hi-Fi equipment. We specialize, too, in TV supply, and are foremost in the field of Builders' Kits.

ALLIED RADIO CORP., Dept. 1-A-5
100 N. Western Ave., Chicago 80, Illinois

Send FREE 308-Page 1955 ALLIED Catalog.

Name _____

Address _____

City _____ Zone _____ State _____

Simpson TECHNICIAN'S NEW PRODUCTS ISSUE

BULLETIN BOARD

IT'S TEST

SAVE
EACH
ISSUE

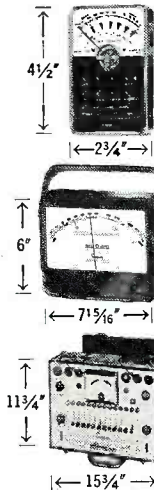

THREE NEW SIMPSON DEVELOPMENTS

NEW MODEL 355 "MIDGETESTER" † . . . Smallest practical Volt-Ohmmeter on the market—2 $\frac{3}{4}$ " x 4 $\frac{1}{2}$ " x 1". Complete multi-tester in a shirt pocket size. Cased in clear lucite. 10,000 Ohms per volt. Five AC and five DC voltage ranges: 0 to 3, 12, 60, 300, and 1200 volts. Four DC resistance ranges: 0 to 10,000 ohms, 100,000 ohms, 1 megohm, and 10 megohms. Price complete with test leads and instructions . . . \$29.95.

NEW MODEL 388 "THERM-O-METER" † . . . Gives fast, accurate, remote temperature readings from -50° F. to +1000° F. on one scale. H 7 $\frac{1}{2}$ ' thermocouple lead, big 7" scale, Adjust-A-Vue handle, and uses internal batteries. Measures 7-15/16" x 6" x 2-15/16". Price complete with lead and batteries . . . \$59.50.

NEW MODEL 1000 PLATE CONDUCTANCE TUBE TESTER . . . Now, fast testing in Plate Conductance with convenient ohms readings for leakage and shorts. Tests any tube—including 9-pin miniatures and subminiatures. Size: 15 $\frac{3}{4}$ " x 11 $\frac{3}{4}$ " x 6". Comes complete with Operator's Manual for only \$135.00.

WORLD FAMOUS "260"

STILL ONLY \$38.95



DELUXE MODEL 262*
20,000 ohms per volt . . . Big
7" Meter in 7" Case . . .
\$59.50

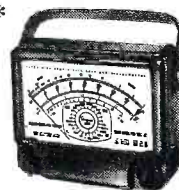

MODEL 269*—100,000 ohms
per volt . . . 33 Ranges
Through Single Control . . .
\$88.00



MODEL 303*
VTVM, \$68.00



*Only Simpson VOM's have Adjust-A-Vue Handle feature for adjusting instrument at any angle on work-bench . . . without extra charge.

† Trade Mark

For Further Information . . . SEE YOUR JOBBER

SIMPSON ELECTRIC COMPANY

WORLD'S LARGEST MANUFACTURER OF ELECTRONIC TEST EQUIPMENT

5216 W. Kinzie St., Chicago 44, Illinois. Phone: ESTbrook 9-1121

In Canada: Bach-Simpson, Ltd., London, Ontario

Simpson's New VARIDOT† . . . A WHITE DOT GENERATOR WITH VARIABLE DOTS

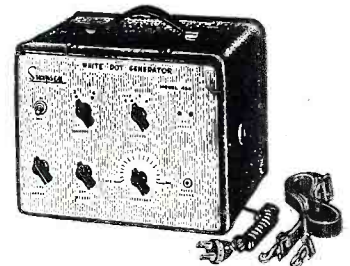

With the new Simpson Model 434 White VARIDOT Generator, you can adjust the number and size of dots to your own liking . . . size being adjustable from one line to six or more—the only white dot generator on today's market that can do this.

You can make linearity adjustment of black-and-white TV, and linearity and convergence adjustments on color TV receivers with confidence . . . easier adjustment of aspect ratio, vertical and horizontal linearity, beam centering, and purity.

Vertical and horizontal synchronization provided by the VARIDOT Generator assures correct aspect ratio, ample attenuation, and a 300-ohm RF output.

The VARIDOT gives fast, accurate checks of transient response of video amplifiers; positive or negative video output is provided.

It is designed for a line voltage of 117 volts, 50-60 cycles, and takes 45 watts. Weighs an easy-to-carry 11 $\frac{1}{2}$ pounds. Case is finished in attractive, Simpson gray hammerloid.

Price, complete with shoulder strap and operating instructions, is \$147.50. See it at your jobber's.

RADIO & TELEVISION NEWS

COLOR TV

Will Today's Servicing Equipment Become Obsolete Tomorrow?

By Bob Middleton

The advent of color TV brings a puzzling problem to many a TV serviceman. He would like to purchase his color test equipment now, and get the jump on his competition. On the other hand he fears that the equipment he buys today may soon become obsolete.

Traditionally, Simpson has always designed its test equipment to protect the serviceman against obsolescence. This policy has already

paid off: first, in the ease with which Simpson black-and-white TV test equipment could be adapted to UHF, and now, its easy adaption to color.

In the future, as in the past, we at Simpson will continue to make every effort to protect the investment of the servicemen who purchase our equipment.



Bob Middleton

HERE! NEW SIMPSON EQUIPMENT FOR COLOR

SAVE EACH ISSUE

TWO NEW SIMPSON ACCESSORIES CONVERT YOUR 480 OR 479 TO COLOR TV TESTING

Get double duty out of your Simpson model 480 Genescope † or Model 479 AM-FM Signal Generator.

The new Simpson Chromatic Probe † and Chromatic Amplifier † convert the above equipment into chromatic sweep marker systems in just 15 seconds. (All connections are external.)

Besides providing for alignment and adjustments of color TV receivers, these two new accessories actually increase the black-and-white applications of the 480 and 479.

The price of the Model 406 Chromatic Amplifier, complete with instructions, is only \$24.95; the Model 0186 Chromatic Probe, only \$9.95.

MODEL 480
AM-FM
GENESCOPE†
\$475.00

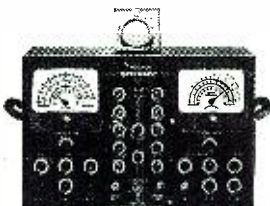

MODEL 479
AM-FM SIGNAL
GENERATOR
\$325.00



NEW SIMPSON COLORSCOPE HAS EVERYTHING YOU NEED IN AN OSCILLOSCOPE FOR SERVICING COLOR TV

Does a Better Job on Black-and-White Sets, Too!

Seven big features make Model 458 the ideal scope for color TV servicing:

- (1) 7" Cathode Ray Tube.
- (2) On wide band operation, the frequency response is flat within 3 db to 4.5 Mc (will adequately display COLOR BURST frequency) with a sensitivity greater than 100 MV rms per inch of vertical deflection.
- (3) On narrow band operation, the frequency response is flat within 3 db from 10 cycles to 100 kc with a sensitivity greater than 10 MV rms per inch.
- (4) Good square wave response provides accurate representation of synch pulses and composite waveform pattern for trouble shooting video, synch, and sweep circuits.



- (5) Horizontal Sweep, to 50 kc, for expansion of high frequency waveform detail and color burst.
- (6) Vernier and Compensated Decimal Step Attenuator for better signal control.
- (7) Provision for Intensity Modulation of CRT.

The price, complete, is only \$199.95.

NEW
MODEL 406
CHROMATIC
AMPLIFIER†
\$24.95



NEW MODEL 0186
CHROMATIC
PROBE† \$9.95



SIMPSON MODEL 488 FIELD STRENGTH METER

The nominal 50 microvolt basic range of the Model 488 is excellent for fringe area uses. There are also three higher ranges for areas with more signal strength. It is easily adapted for UHF.

Model 488 is designed for 105-125 volts, 50-60 cycles, and takes 45 watts. Weight is 11½ lbs. Price, complete with shoulder strap, is \$115.00.



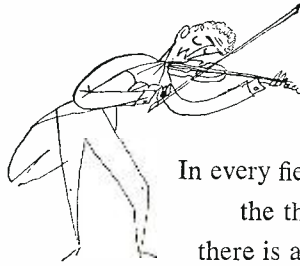
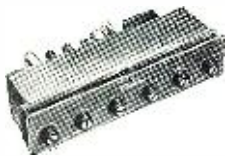
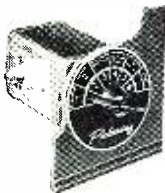
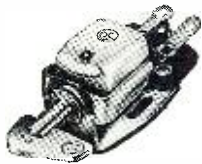

Pickering Audio

Components... **SYNONYMOUS WITH HIGHEST QUALITY** *Design... Manufacture... Performance*

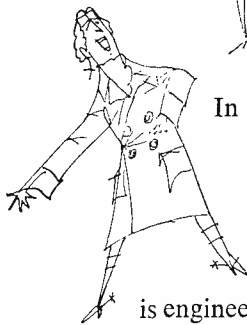

In every field of endeavor . . . manufacturing,
the theatre, concert or contest . . .
there is always one standout.



In HI-FI equipment the standout is Pickering . . .
pioneer in this field, responsible
for the development and introduction of outstanding
components for highest quality performance;
every product bearing the Pickering name
is engineered to conquer the challenge of
optimum performance . . . in their manufacture
the most stringent quality controls are
exercised to assure and maintain the "Ne Plus Ultra"
reputation for products featured by the  emblem.



It's with good reason that professionals use
Pickering Audio Components . . . they know
the values built into Pickering equipment.
INVESTIGATE and you too will use Pickering
components for your HI-FI system. . . .
You'll thrill to new listening experiences . . .
you'll have the same high quality performance
as leading FM/AM good music stations, network
and recording studios . . . **REMEMBER**, leading
record companies use Pickering Components
for quality control.

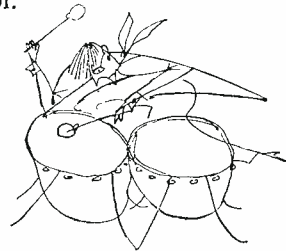

PICKERING and company incorporated •

PICKERING PROFESSIONAL AUDIO EQUIPMENT

Oceanside, L. I., New York

"For those who can hear the difference"

. . . Demonstrated and sold by Leading Radio Parts Distributors everywhere.

For the one nearest you and for detailed literature, write Dept. C-6

RADIO & TELEVISION NEWS

**It's New! 3 Years in Development
-NOW READY FOR YOU!**

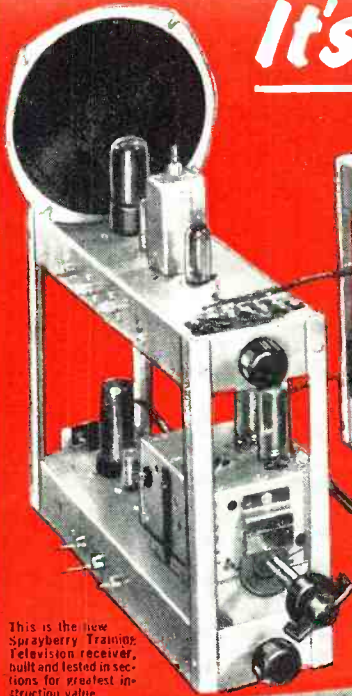

This is the new Sprayberry Trainer Television receiver, built and tested in sections for greatest instruction value.

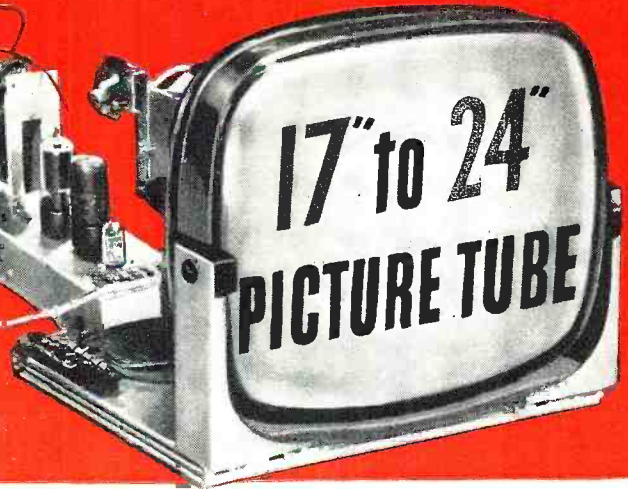
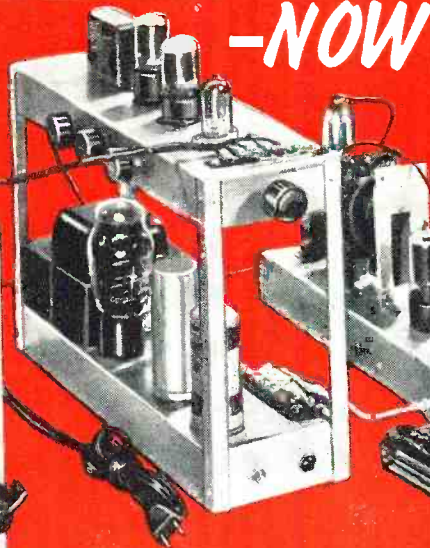

You build the new Sprayberry Tester... 18-range Volt-Ohm-Milliammeter readings plus output meter and condenser and resistor substitution selector.

These photos show only a small part of the training equipment I send my students.

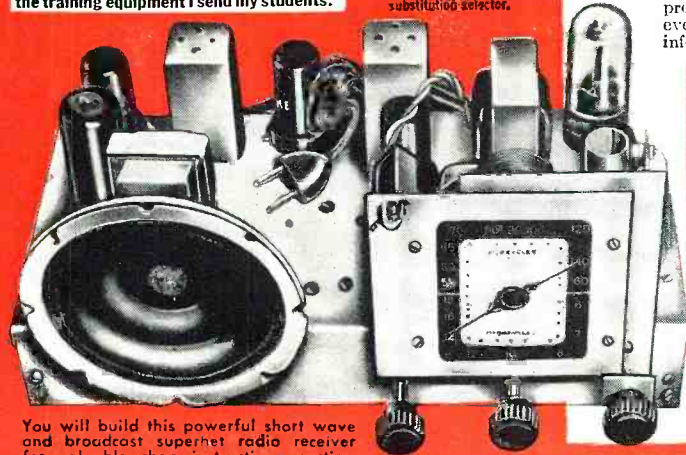

You will build this powerful short wave and broadcast superhet radio receiver for valuable shop instruction practice.

New Equipment! New Lessons! Enlarged Course!
SPRAYBERRY PRACTICAL TRAINING IN
RADIO-TELEVISION
3 NO OBLIGATION TRAINING PLANS



Frank L. Sprayberry
President, Sprayberry
Academy of Radio

You have NO MONTHLY PAYMENT CONTRACT to sign ... pay for this outstanding training as you learn!

The complete facts are so big and so important to any man seeking training in Radio-Television that I urge you to mail the coupon below at once for my big all-new 56 page FREE CATALOG and FREE Sample Lesson. Get the full story of this remarkable new and up-to-the-second Training Plan. You'll read about my 3 NO OBLIGATION PLANS or "packaged unit" instruction for both beginners and the experienced man. You'll learn how I can now prepare you in as little as 10 MONTHS to take your place in this fast moving big money industry as a Trained Radio-Television Technician. You'll see that you take no risk in enrolling for my Training because you DO NOT SIGN A BINDING TIME PAYMENT CONTRACT. I have been training successful Radio-TV technicians for 22 years . . . I can prepare you, too, to get into your own profitable Service Shop or a good paying job, even if you have no knowledge of Radio-Television. Mail the coupon . . . I rush full information FREE and without obligation. (No salesman will call.)

NEWEST DEVELOPMENTS

Your training covers U H F, Color Television, F M, Oscilloscope Servicing, High Fidelity Sound and Transistors.

PRACTICE AND TRAIN AT HOME WITH 25 NEW KITS OF EQUIPMENT

You get valuable practical experience in construction, testing and shop practice. You build a powerful 2 band superhet radio, the all-new 18 range Sprayberry multimeter, the new Sprayberry Training Television receiver, signal generator, signal tracer and many other projects. All equipment is yours to use and keep . . . and you have practically everything needed to set up a Radio-Television Service Shop.

All your training is IN YOUR HOME in spare hours. Keep on with your present job and income while learning. I help you earn extra spare time money while you learn. If you expect to be in the armed forces later, there is no better preparation than practical Sprayberry Radio-Television training. Rush coupon below for all the facts—FREE!

SPRAYBERRY ACADEMY OF RADIO
 111 NORTH CANAL STREET, DEPT. 25-T, CHICAGO 6, ILLINOIS

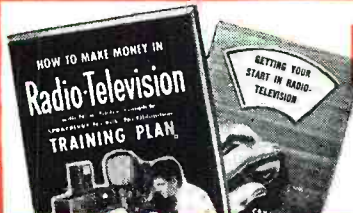

FREE CATALOG AND SAMPLE LESSON

Rush coupon for my catalog "How to Make Money in Radio-Television". PLUS an actual sample Sprayberry Lesson without obligation—ALL FREE. Mail coupon NOW!

SPRAYBERRY ACADEMY OF RADIO MAIL THIS COUPON FOR FREE
 Dept. 25-T, 111 N. Canal St., Chicago 6, Ill. FACTS AND SAMPLE LESSON

Please rush all information on your ALL-NEW Radio-Television Training Plan. I understand this does not obligate me and that no salesman will coll upon me. Include New Catalog and Sample Lesson FREE.

Name _____ Age _____

Address _____

City _____ Zone _____ State _____

GET BETTER PERFORMANCE From TV-Deflection and High-Voltage Circuits...

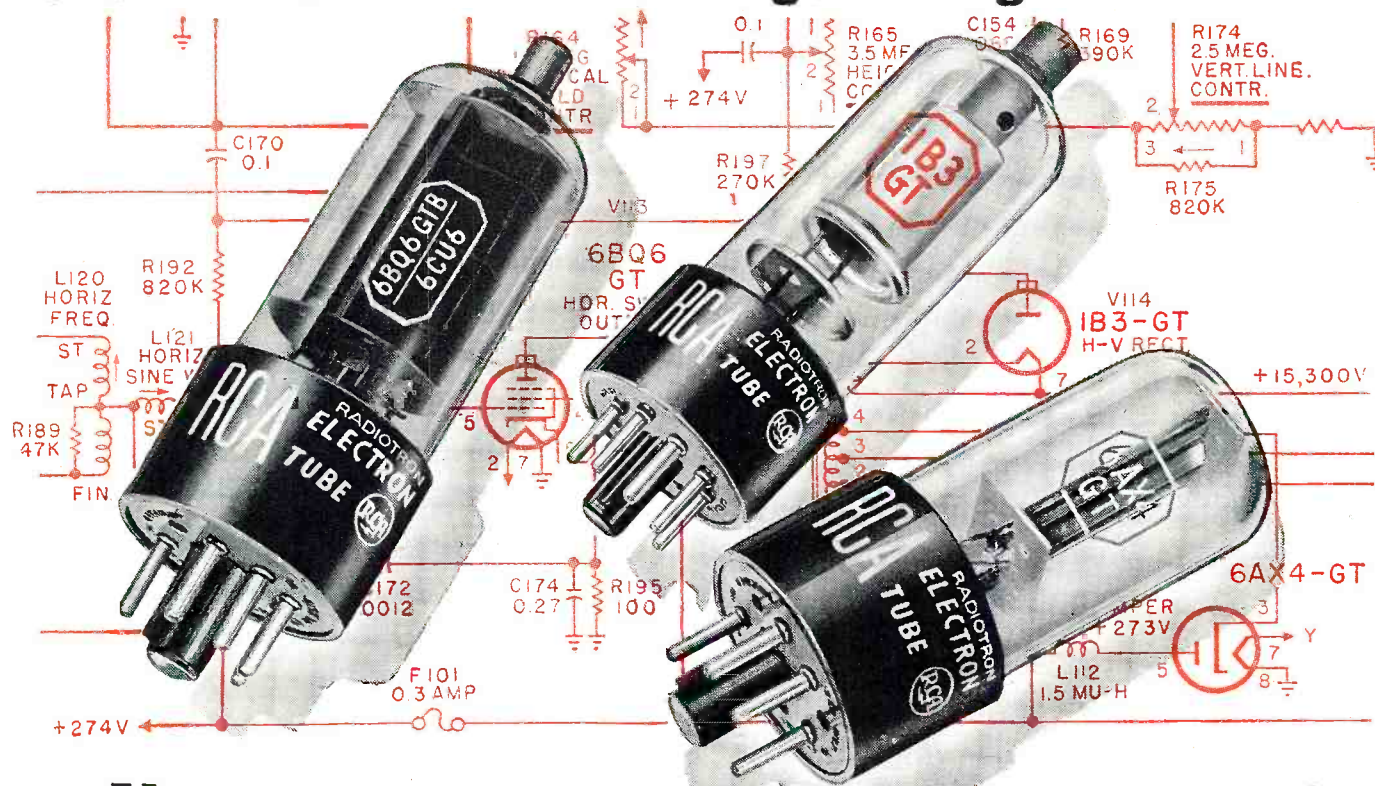

Use **RCA TUBES**...with built-in quality!

Better performance and longer life are *built into* each RCA Tube. In TV Deflection and High-Voltage Circuits, RCA Tubes operate with high efficiency. That's because rigid structural specifications help them to deliver the required currents or to withstand the high voltages. For instance, on the new RCA 6BQ6GTB/6CU6 striking structural changes have produced a decidedly uniform temperature radiation and new cathode material assures greater reliability. You get greater deflection and higher efficiency. RCA's severe dynamic life tests simulate actual operating conditions and help assure you better-performing, long-life tubes.



When you replace with RCA Tubes, your customers are sure of dependable performance. Insist on genuine RCA Tubes for all your service work!



RADIO CORPORATION OF AMERICA
ELECTRON TUBES
HARRISON, N.J.

First Choice for TV circuits...dependable RCA Tubes!

GREAT NATION-WIDE MID-WINTER SALE!

The famous, best-selling

irish **BROWN**
BAND
BRAND

Plastic Base Recording Tape



One 1200 ft. Reel FREE

When You Buy 5 1200 ft. Reels!

A \$15.00 Hi-Fi Net Value for Only \$12.50

**USED AND RECOMMENDED BY HOME RECORDING
ENTHUSIASTS, SCHOOLS, BUSINESSES, ETC.**

irish "Brown Band" is one of the most popular of the famous IRISH Brand line of recording tapes. IRISH "Brown Band" plastic base tape is extensively used in homes, schools, offices, and for all general-purpose recording. Now, for the first time in January, stores all over the country are featuring this tape in a special mid-winter sale. You get six 1200-ft. reels for the price of five — a saving of \$2.50. It's a once-a-year opportunity to stock up with a recording tape you can trust. Remember this — you're not buying an off-brand, you're getting the genuine, the nationally advertised IRISH "Brown Band" used by the experts.

irish "Brown Band" is the only plastic base, high quality recording tape specifically designed for home recorders. It reproduces, with true fidelity, the frequency range between 100 and 8000 cps., the range that most popular recorders are capable of handling. It is wound on the new and improved 2½ inch hub heavy reel, and every reel comes with the exclusive IRISH Reel-tab for quick and ready identification.

ORRadio Industries, Inc.

OPELIKA, ALABAMA

America's Pioneers in Magnetic Tape

Export: Morhan Exporting Corp., New York, N. Y.
Canada: Atlas Radio Corp., Ltd., Toronto, Ontario

Here's What Users Say:

"Your IRISH Brown 195RPA tape is all right the way it is. Do not change the tape, nor the reels, nor anything which will alter the bargain you now offer of a high quality standard tape for a low price."

— C. H. S., San Francisco, California

"This piece of (Brown Band) tape is cut from a reel in its 100th recording. The reel from which it was taken has had a very severe test (climatic conditions in South Africa are extreme) and has had some rough handling, but it is still good."

— M. H. N., Pietermaritzburg, Natal

Here's the Deal!

**Buy 5 Reels of irish
Brown Band (1200-ft.) and
get another reel FREE!**

6 Reels for the
Price of 5 —
A \$15.00 Value
for only \$12.50

Buy a whole year's supply. IRISH "Brown Band" keeps indefinitely. Present this coupon to your nearest Radio Parts Dealer or Hi-Fi Dealer. It will entitle you to this special sale deal. If they can't supply you, order direct from our factory, including 50¢ for postage and mailing.

**BUY DIRECT...
SAVE MONEY!**

**HI-FI and
Binaural units...
wired or kits!**

New Imperial V-12-tube AM-FM Tuner Kit

- Band width — 200 kc • Tuned RF stage • Tuning Range 88-108 mc • Sensitivity 5-10 u/v, 20-30 db
- Iron core tuned I.F. disc. trans. • 6CB6 RF amplifier • 6AB4 mixer • 6AB4 oscillator • 6AU6 1st I.F. amplifier • 6AU6 2nd I.F. amplifier • 6AU6 1st limiter • 6AU6 2nd limiter • 6AL5 detector • 6C4 cathode follower output • AM tuning range 530-1650 kc • 6BA6 RF amplifier • 6BE6 converter • 6BA6 1st I.F. amplifier • 1N34 or 1N60 crystal diode detector • Tuned RF stage • Chassis dimensions: 9 3/4" long, 5" high, 8" W.

Complete kit of parts including tubes, pictorial and schematic diagrams... **\$37.50**

Frequency Response (FM) 20 — 20,000 CPS ± .5 DB

Frequency Response (AM) 20 — 7,500 CPS ± 3 DB

New V-9 FM Receiver Kit

- Self-contained AC Power Supply
- 3 section variable condenser • Tuning range 88-108 mc • Band width 200 kc • Sensitivity 10 microvolts 20 db • Tuned RF stage • Iron core tuned I.F. — disc. trans. • 6CB6 R.F. amplifier • 6AB4 mixer • 6AB4 oscillator (temp. compensated) • 6AU6 1st I.F. amplifier • 6AU6 2nd I.F. amplifier • 6AU6 1st limiter • 6AU6 2nd limiter • 6AL5 detector • 6C4 cathode follower output • #65 selenium rectifier • Dimensions 9 3/4" x 5" x 5 3/8"

Complete kit of parts including AC power supply, tubes, pictorial and schematic diagrams... **\$29.50**

Frequency response 20-20,000 CPS ± .5 DB

Wired & Tested extra... **\$5.00**

New V-5 AM Receiver Kit

- Self-contained AC power supply
- Tuning range 530-1650 kc • 6BA6 RF Amplifier • 6BE6 converter • 6BA6 1st I.F. amplifier • 6AL5 detector • 6C4 cathode follower output • #65 selenium rectifier • 3 section variable cond. • Tuned RF stage • Sensitivity 5 microvolts • Iron core tuned coils throughout • Dimensions 9 3/4" x 5" x 5 3/8"

Complete kit of parts, including AC power supply, tubes, pictorial and schematic diagrams... **\$24.50**

Frequency Response 20-7,500 CPS ± 3 db

Wired & Tested extra... **\$4.25**

FREE CATALOG OFFER!

Write today for free complete 400-page catalog!

ORDER DIRECT FROM



APPROVED

ELECTRONIC INSTRUMENT CORP.

523 BROADWAY NEW YORK 30, N. Y.

©1951

Spot Radio News

* Presenting latest information on the Radio Industry.

By RADIO & TELEVISION NEWS'
WASHINGTON EDITOR

EDUCATIONAL TV, which has generated a raging storm of protests and disputes among broadcasters, industry experts and government agencies, since the Commission decided to set aside 242 channels for telestudy, received its roughest lambasting recently, and from none other than the newly appointed chairman, Frank C. McConaughy.

At a combined luncheon-meeting of educators and radio-TV executives in New York City, he charged that school heads have not really accepted the keen challenge of the FCC, since in the two years that have passed, only seven colleges have TV stations on the air.

Recognizing the problem of funds, he said that if the dollar situation continued to be a stumbling block for too many, then the present plan might have to be altered. He felt that if "... an educational presentation is made attractive enough to invite public interest, it can usually find some place on the program of a local station..." and that approach might be a solution.

Noting, however, that while the question of an available budget was important, he believed that it wasn't always the real difficulty, and he cited the case of the FM allocations in '45, when 20 channels were set aside for educators. Despite the low-cost transmitters available, the FCC headman declared, the "... educational response to FM's opportunities has been disappointing. FCC authorized low-power operation and later remote control of FM, and yet today, this considerable space in an otherwise congested spectrum is still going begging."

Commenting on programming, another important factor in the problem, he said, "This is a day of highly competitive program selection. The general public is so accustomed to depending upon commercial radio and TV for entertainment, enlightenment, and relaxation, that educational subjects must be expertly presented in order not to bore a critical viewing or listening public which is quick to turn the knob."

The chairman's views were sharply criticized by Madame Commissioner Frieda Henneck during a news conference which followed the luncheon. Declaring that educators could cooperate with commercial broadcasters and should explore means of tying in with campus networks, closed-circuit TV,

and community antenna systems, she tagged these as suggestions of commercial interests. Educators "... will not be relegated to closed-circuit TV..." she told newsmen, for school systems need their own media.

TV, once more, has come to the aid of the military; this time with a fixed gunnery trainer, a classroom device for teaching fighter pilots the tactical use of a modern fire-control system.

The new flight simulator was developed in cooperation with the Wright Air Development Center. It employs a television pickup and projection system which portrays a realistic simulation of air-to-air and air-to-ground targets and maintains a continuous true-to-life spacial situation between interceptor and target, regardless of course, speed, or type of maneuver. The gunnery controls, flight controls, instruments, and flight characteristics are identical to those in the F-86 aircraft. Approximate dimensions of the trainer are 52' by 24' by 18'.

CONTINUING ITS STRIDENT PROGRAM to develop assorted control standards for lab and field use, the Bureau of Standards has now come up with a portable one-megacycle frequency standard, said to be stable to a few parts in 100-million per day.

Developed by Peter G. Sulzer, the instrument consists of three elements; crystal unit, amplifier or negative-resistance device to supply the losses in the crystal unit and to deliver power to a load, and an amplitude control. Since the oscillator was specifically designed to minimize frequency changes caused by tube or component instability, the over-all stability of the unit has been found to be nearly that of the crystal itself.

Analyzing the characteristics of the new unit, the Bureau said that any phase shift in the amplifier must be offset by a corresponding but opposite phase shift in the crystal unit, which will produce a frequency change. Such a phase shift can be caused by an actual reactance change or by a variation in the reactive component of the input impedance of the tube. Phase shifts, it was pointed out, can also be produced by the electronic component of the input capacitance of a tube, by transit time, and by the effects of nonlinearity.

FIND THE RIGHT TV Yoke Capacitor IN A JIFFY!

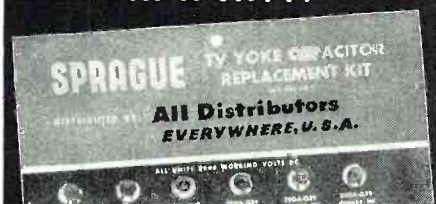

Just try the different ceramics in this Sprague TV Yoke Capacitor Replacement Kit until you get a good picture. That's all there is to it! 36 famous Sprague Cera-Mite® Capacitors, in eight different values selected and proportioned on the basis of actual need, providing complete coverage of fractional values between 33 mmf and 82 mmf. The tiny ceramic discs fit any yoke assembly . . . stand up under the toughest service . . . are excellent replacements for any 2000 volt capacitor which may appear in original equipment. Complete instructions are on the face of the tough, paper-board card, conveniently punched for hanging over the service bench. Get yours now! Ask your distributor for Sprague Kit CK-1. Only \$12.60 List!

SPRAGUE PRODUCTS COMPANY
Distributors' Division of the Sprague Electric Co.
NORTH ADAMS, MASS.

don't be vague . . .

do it the easy way



for finding opens, shorts, or intermittents in a jiffy.

*Trademark

SPRAGUE

NORTH ADAMS, MASS.
January, 1955

Beware the Service Bargain..

You'll never see your doctor advertise a special sale on appendectomies . . .
You'll never see your lawyer announce cut-rates for divorce cases . . .
You'll never see your dentist hold a "2-for-1" sale on extractions . . .
AND You'll never see the day when you can take your TV set in for a service "bargain" and be sure you're getting a square deal!

"Bargains" in home electronic service are as scarce as the proverbial hen's teeth! Here's why—

The expert service technician, just like other professional people, must undergo years of study and apprenticeship to learn the fundamentals of his skill. And a minimum investment of from \$3000 to \$6500 per shop technician is required for the necessary equipment to test today's highly complex sets. Finally, through manufacturer's training courses and his own technical journals, he must keep up with changes that are developing as fast as they ever did in medicine, law, or dentistry. Those best equipped to apply modern scientific methods are almost certain to be most economical for you and definitely more satisfactory in the long run.

Unfortunately, as in any business, there will always be a few fly-by-night operators. But patients, clients, and TV set owners who recognize that you get only what you pay for, will never get epped. There just ARE no service bargains . . . but there is good service awaiting you at FAIR PRICES!

Harry Nelson
REGISTERED
SPRAGUE PRODUCTS COMPANY
North Adams, Mass.

SPRAGUE
WORLD'S LARGEST MANUFACTURER OF ELECTRIC CONDENSERS

- Put it on your counter
- Send it with your bills
- Leave it on service calls
- Send it to your mailing list

BUILD THE REPUTATION YOU DESERVE . . .

Simply and clearly, "Beware The Service Bargain" tells the story you want to get across to your customers. Why you . . . on the basis of receiver complexity, years of training, and capital equipment required . . . are just as entitled to a fair price for your service as doctors, lawyers, and dentists. And, why there can't be any such thing as a service "bargain."

This may be your last chance to get reprints of "Beware The Service Bargain" in an ideal size for mailing, and with adequate space for your imprint *at cost*: \$3.00 for 1000; \$25.00 for 10,000. Order Form RP10 through your distributor or directly from the Sprague Products Co.,* 51 Marshall Street, North Adams, Massachusetts.

Mats for newspaper advertising are also available.

*Distributors' Division of Sprague Electric Co.

don't be vague . . . insist on

SPRAGUE

WORLD'S LARGEST CAPACITOR MANUFACTURER

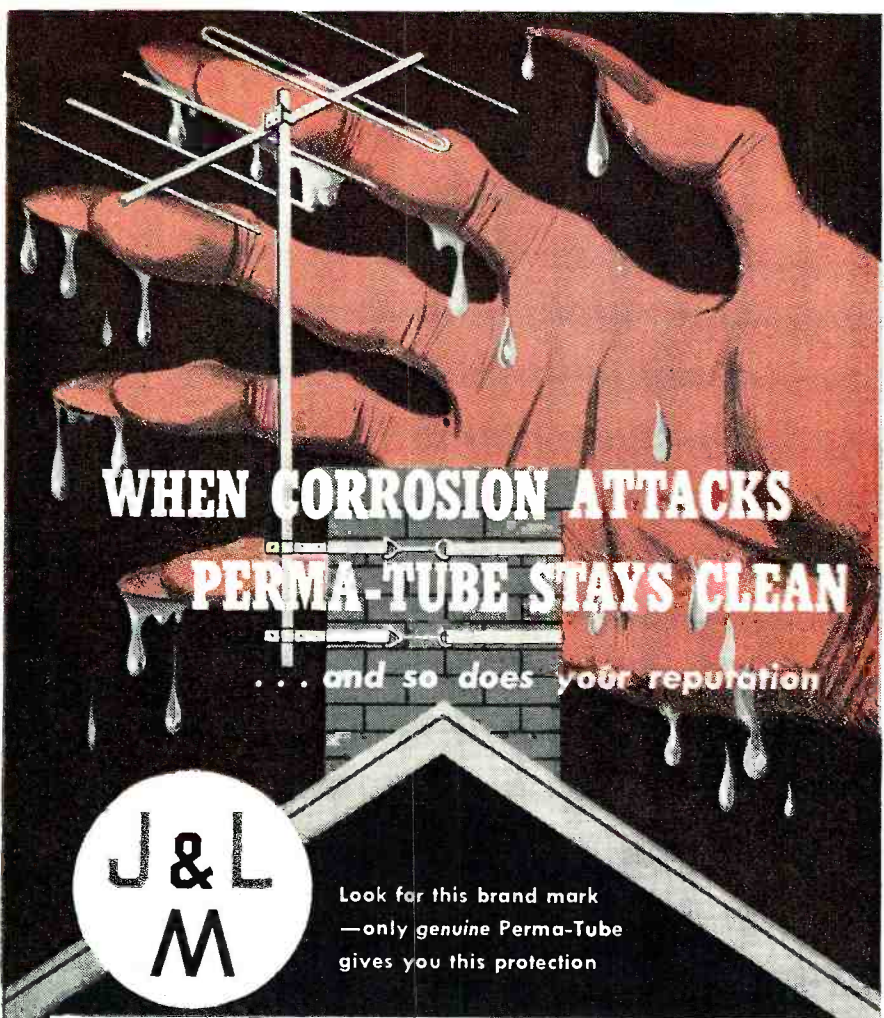

**WHEN CORROSION ATTACKS
PERMA-TUBE STAYS CLEAN**

... and so does your reputation

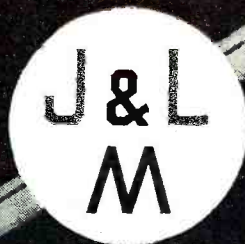

Look for this brand mark
—only genuine Perma-Tube
gives you this protection

Here's why PERMA-TUBE backs up quality service:

1. **PERMA-TUBE IS CORROSION-PROOF** . . . it's treated with vinyntite—then coated *inside and outside* with a metallic vinyl resin base. It's guaranteed to be free from rust in a salt spray test of 500 hours minimum to an American Society of Testing Materials Specification B117-49T. This assures long life.
2. **PERMA-TUBE IS STURDY** . . . it's made of special, high-strength J&L Steel.
3. **PERMA-TUBE IS EASILY INSTALLED** . . . it's the only mast with *both ends* of the joint machine fitted.

Here's proof of how PERMA-TUBE resists corrosion:

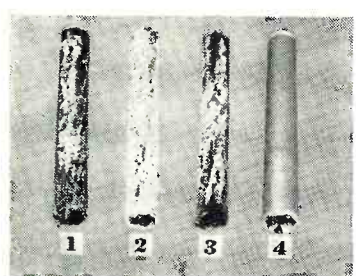

1. Coated Mechanical Tubing . . . note that galvanized coating is gone and underlying steel is severely corroded.
2. Coated Mechanical Tubing . . . note that paint coating is nearly destroyed and zinc coating is corroded.
3. Galvanized Mechanical Tubing . . . note zinc and steel are corroded.
4. PERMA-TUBE . . . note that Perma-Tube is relatively unharmed.

Test samples after 1440 hours
ASTM salt spray test



For further details on product and installation, write for a copy of the Perma-Tube booklet. Jones & Laughlin Steel Corporation, Dept. 495, 3 Gateway Center, Pittsburgh 30, Pa.

Jones & Laughlin
STEEL CORPORATION — Pittsburgh

In the NBS oscillator, the effects of these amplifier variations are decreased by the use of inverse feedback. The well-known Meacham bridge oscillator circuit has been used, because it was found to provide excellent results, and with comparatively simple circuitry.

The Meacham bridge consists basically of a crystal resistance, a pair of resistors, and a lamp resistance. These components are so arranged that negative feedback occurs through the resistance of the crystal and one of the resistors, while positive feedback occurs through the lamp and the other resistor. If the amplifier has sufficient gain, oscillation starts at the frequency of minimum degeneration, which is nearly the series-resonant frequency of the crystal, and the lamp resistance will increase with the amplitude of oscillation until the bridge is nearly balanced. When an equilibrium is reached, the bridge attenuation must equal the amplifier gain.

The standard employs a 20-ohm glass-enclosed, contoured AT-cut crystal with a Q of 5×10^6 , and a maximum current limitation of one milliampere. To obtain the best frequency stability, the crystal is kept in an oven at a specified, constant temperature. The oven is of a single-stage type, with temperature control provided by a 50° mercury thermostat. Frequency changes in the crystal due to oven cycling have been found to be less than 10^{-6} cps, and normal lab temperature changes have not been found to reflect in the temperature of the crystal.

ANOTHER UNUSUAL BUREAU development has also appeared in the form of a subharmonic crystal oscillator, which requires only a single triode in a blocking oscillator, coupled to a quartz crystal. Each output pulse of the oscillator shock excites the crystal, and the voltage generated by the crystal, as it continues to vibrate or ring, synchronizes the oscillator at a submultiple of the crystal frequency. With some crystals, it has been reported, the circuit has been operated successfully at division rates as high as 10,000 to 1, producing harmonic-rich output at 100 cps controlled by a 1000 kilocycle-per-second crystal.

The circuit was a chance discovery of M. C. Thompson, Jr., of the NBS sound section, who, while working on a project sponsored by the Navy, noticed that some equipment was oscillating in an unexpected fashion.

In an ordinary blocking oscillator, we have the plate circuit of a tube coupled by means of a transformer to a resistor-capacitor combination in the grid circuit. When plate voltage is first applied, the grid is at zero potential with respect to cathode, and plate current starts to flow through the primary or plate winding of the transformer. This current quickly produces a large voltage pulse in the secondary that charges the capacitor in the grid

(Continued on page 133)



I Will Train You at Home

for Good Pay Jobs, Success in

RADIO-TELEVISION

J. E. SMITH
President
National Radio
Institute
Washington, D. C.
40 years of success
training men at
home in spare time.



Practice Broadcasting with Equipment I Send

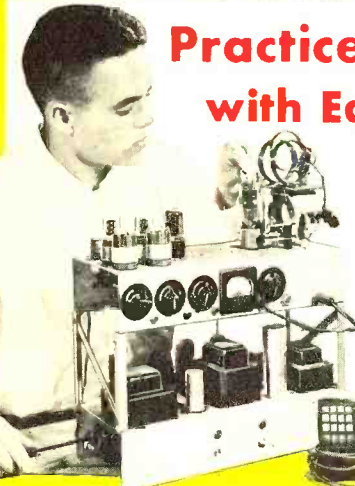

As part of my Communications Course I send you kits of parts to build the low-power Broadcasting Transmitter shown at the left. You use it to get practical experience putting a station "on the air," performing procedures demanded of Broadcasting Station Operators. An FCC Commercial Operator's License can be your ticket to a better job and a bright future; my Communications Course gives you the training you need to get your license. Mail card below and see in my book other valuable equipment you build.



Practice Servicing with Equipment I Send

Nothing takes the place of PRACTICAL EXPERIENCE. That's why NRI training is based on LEARNING BY DOING. You use parts I furnish to build many circuits common to Radio and Television. With my Servicing Course you build a modern Radio (shown at right). You build a Multitester which you use to help fix sets while training. Many students make \$10, \$15 a week extra fixing sets in spare time starting a few months after enrolling. All equipment is yours to keep. Card below will bring book showing other equipment you build.



Television is Growing Fast Making New Jobs, Prosperity

More than 25 million homes now have Television sets and thousands more are being sold every week. Well trained men are needed to make, install, service TV sets. About 200 television stations on the air with hundreds more being built. Think of the good job opportunities here for qualified technicians, operators, etc. If you're looking for opportunity get started now learning Radio-Television at home in spare time. Cut out and mail postage free card. J. E. Smith, President, National Radio Institute, Washington, D. C. OUR 40TH YEAR.

AVAILABLE TO
VETERANS
UNDER G.I. BILL

Good Jobs, Good Pay, Success
in Radio-TV! SEE OTHER SIDE

CUT OUT AND MAIL THIS CARD NOW

Sample Lesson & 64-Page Book
Both FREE

This card entitles you to Actual Lesson on Servicing, shows how you learn Radio-Television at home. You'll also receive my 64-Page Book, "How to Be a Success in Radio-Television." Mail card now!

NO STAMP NEEDED! WE PAY POSTAGE

Mr. J. E. SMITH, President,
National Radio Institute, Washington 9, D. C.

Mail me Lesson and Book, "How to Be a Success in Radio-Television." (No Salesman will call. Please write plainly.)

NAME AGE

ADDRESS

CITY ZONE STATE

VETS write in date of discharge

J K

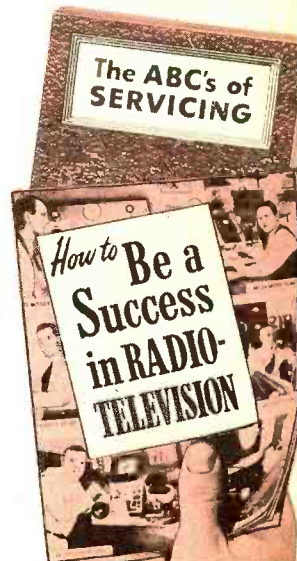

Train at Home to Jump Your Pay as a RADIO-TV Technician



**J. E. Smith, President
National Radio Institute**

The men whose messages are published below were not born successful. Not so long ago they were doing exactly as you are now... reading my ad! They decided they should KNOW MORE... so they could EARN MORE... so they acted! Mail card below now.

Get a Better Job—Be Ready for a Brighter Future in America's Fast Growing Industry

Training PLUS opportunity is the PERFECT COMBINATION for job security, good pay, advancement. When times are good, the trained man makes the BETTER PAY, GETS PROMOTED. When jobs are scarce, the trained man enjoys GREATER SECURITY. NRI training can help assure you and your family more of the better things of life.

Radio-Television is today's opportunity field. Even without Television, Radio is bigger than ever before. Over 3,000 Radio Broadcasting Stations on the air; more than 115 million home and Automobile Radios are in use. Then add Television. Television Broadcast Stations extend from coast to coast now with over 25 million Television sets already in use. There are channels for 1,800 more Television Stations. Use of

Aviation and Police Radio, Micro-Wave Relay, Two-way Radio communication for buses, taxis, trucks, etc. is expanding. New uses for Radio-Television principles coming in Industry, Government, Communications and Homes.

My Training is Up-to-Date You Learn by Practicing

Get the benefit of my 40 years experience training men. My well-illustrated lessons give you the basic principles you must have to assure continued success. Skillfully developed kits of parts I furnish "bring to life" the principles you learn from my lessons. Read more about equipment you get on other side of this page.

Naturally, my training includes Television. I have, over the years, added more and more Television information to my courses. The equipment I furnish students gives experience on circuits common to BOTH Radio and Television.

Find Out About the Tested Way to Better Pay

Read at the right how just a few of my students made out who acted to get the better things of life. Read how NRI students earn \$10, \$15 a week extra fixing Radios in spare time starting soon after enrolling. Read how my graduates start their own businesses. Then take the next step—mail card below.

You take absolutely no risk. I even pay postage. I want to put an Actual Lesson in your hands to prove NRI home training is practical, thorough. I want you to see my 64-page book, "How to Be a Success in Radio-Television" because it tells you about my 40 years of training men and important facts about present and future Radio-Television job opportunities. You can take NRI training for as little as \$5 a month. Many graduates make more than the total cost of my training in two weeks. Mailing postage free card can be an important step in making your future successful. J. E. Smith, President, National Radio Institute, Washington 9, D. C. OUR 40TH YEAR.

I TRAINED THESE MEN



Consultant on Antenna Systems

"I resigned as Chief Engineer. Now I am on my own as consultant on private and commercial antenna systems." R. J. Bailey, Weston, W. Va.



\$10 a Week in Spare Time

"Before finishing, I earned as much as \$10 a week in Radio servicing, in my spare time. I recommend NRI." S. J. Petruff, Miami, Fla.



Control Operator, Station WEAN

"I received my license and worked on ships. Now with WEAN as control operator, NRI course is complete." R. Arnold, Rumford, R. I.



Has Own Radio-Television Shop

"Doing Radio and Television servicing full time. Have my own shop. I owe my success to NRI." Curtis Stath, Fort Madison, Iowa.



Radio-Television Service Chief

"Am chief Radio and Television serviceman for large repair shop. Pay very good; working conditions pleasant." P. G. Brogan, Louisville, Ky.



Got First Job Through NRI

"My first job was with KDLR. Now, Chief Engr. of Radio Equipment for Police and Fire Dept." T. Norton, Hamilton, Ohio.

Start Soon to Make \$10 to \$15 a Week Extra Fixing Sets



Keep your job while training. Many NRI students make \$10, \$15 and more a week extra fixing neighbors' Radios in spare time, starting a few months after enrolling. I start sending you special booklets that show you how to fix sets, the day you enroll. The multimeter you build with parts I furnish helps discover and correct troubles.

SEE OTHER SIDE

My Training Leads to Jobs Like These

- | | | |
|-------------------------------|---|------------------------------------|
| BROADCASTING | Service Manager | AVIATION RADIO |
| Chief Technician | Tester | Plane Radio Operator |
| Chief Operator | Serviceman | Transmitter Technician |
| Power Monitor | Research Assistant | Receiver Technician |
| Recording Operator | | Airport Transmitter Operator |
| Remote Control Operator | | |
| | SHIP AND HARBOR RADIO | TELEVISION |
| SERVICING | Chief Operator | Pick-Up Operator |
| Home and Auto Radios | Assistant Operator | Voice Transmitter Operator |
| P.A. Systems | Radiotelephone Operator | Television Technician |
| Television Receivers | | Remote Control Operator |
| Electronic Controls | GOVERNMENT RADIO | Service and Maintenance Technician |
| FM Radios | Operator in Army, Navy, Marine Corps, Coast Guard | |
| IN RADIO PLANTS | Forestry Service Dispatcher | POLICE RADIO |
| Design Assistant | Airways Radio Operator | Transmitter Operator |
| Transmitter Design Technician | | Receiver Serviceman |

FIRST CLASS
Permit No. 20-R
(Sec. 34.9, P.L.&R.)
Washington, D.C.

BUSINESS REPLY CARD

No Postage Stamp Necessary If Mailed In The United States

POSTAGE WILL BE PAID BY

NATIONAL RADIO INSTITUTE

16th and U Sts., N.W.

Washington 9, D. C.

CUT-OUT-MAIL Postage Free CARD

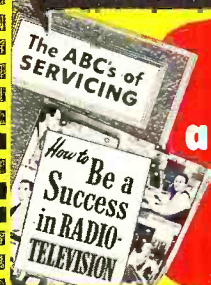

SAMPLE LESSON and 64-PAGE BOOK Both FREE

Have Your Own Business

Many NRI trained men start their own successful Radio-Television sales and service business with capital earned in spare time. Joe Travers, a graduate of mine, in Asbury Park, N. J., writes: "I've come a long way in Radio and Television since graduating. Have my own business on Main Street."



NEW

SYLVANIA

TUBE *and* TOOL TENDER

...ends
"tool hunting"
for good!



Here's the newest idea in TV service cases. It's the Tube and Tool Tender's "PEG PLATE" panels and adjustable metal holders. With this combination, set up your tools in the arrangement that suits you best. Then enjoy the time- and temper-saving convenience of having the tools you want, right where you want them, whenever you need them.

And of course the Sylvania Tube and Tool Tender also gives you generous tube and equipment storage.

Your Sylvania Distributor has your Tube and Tool Tender now. It's another Sylvania exclusive, designed for your easier TV servicing, offered only by your Sylvania Distributor.

It's spacious—carries tubes, tools, meter, mirror, parts . . . everything you need on your calls.

See it at your Sylvania Distributor

FREE
with the purchase of
Sylvania Tubes

\$15.95 VALUE

...for only
32 Sylvania Tokens

Remember, you get one Sylvania Token each time you buy 25 Sylvania Receiving Tubes.

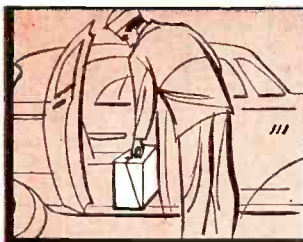

It's light and attractive, it's aluminum . . . weighs only 20 pounds fully loaded.



It's durable and sturdy—will stand up in constant field use.

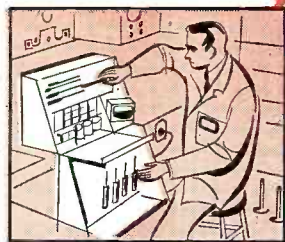

It's convenient—for shop as well as field use. Complete with "shelf-service."



SYLVANIA

Sylvania Electric Products Inc.
1740 Broadway, New York 19, N. Y.
In Canada: Sylvania Electric (Canada) Ltd.
University Tower Bldg., St. Catherine St.
Montreal, P.Q.

LIGHTING • RADIO • ELECTRONICS • TELEVISION • ATOMIC ENERGY

January, 1955

21

FIX ANY TV or

This professional SERVICE TRAINING IS THE KIND THAT REALLY "PAYS OFF"!

Let these two up-to-the minute Ghirardi books make it easy for you to handle ALL types of AM, FM and Television receiver service by the very best and latest methods! Learn to handle jobs faster, better . . . and with less testing! Whether you're a service beginner or an experienced technician you'll find the speedy, professional methods that are so clearly explained can give BOTH your service efficiency and your earnings a big boost!

Almost 1500 pages and over 800 big, clear pictures and diagrams explain EVERY troubleshooting and repair operation so simply it's next to impossible to go wrong. Each book contains up-to-date data on the latest methods and equipment.

Better yet, you can save \$1.25 by buying both together! Send no money. Practice from these great books for 10 full days FREE.

Mail coupon today to Rinehart & Co., Inc., Dept. RN-15, 232 Madison Ave., New York 16, N. Y.

Radio & Television Receiver

1 Circuitry & Operation

by Ghirardi & Johnson
669 pages, 417 clear illustrations, \$6.50

It's lots easier to repair ANY radio or television set when you know all about its circuits and just why and how each one works! You locate troubles in much less time and with less testing. You repair them faster, better—more profitably!

That's why *Radio & Television Receiver CIRCUITRY AND OPERATION* is invaluable to servicemen who want to be well equipped to handle today's complicated receivers! First it gives a complete understanding of basic circuits and their variations. It teaches

you to recognize each one quickly. Then it shows how to eliminate useless testing and guesswork in making repairs.

Throughout, this book gives you the kind of above-average training that takes the "headaches" out of servicing—the kind that fits you for the better-paid jobs. Covers all basic circuits used in modern TV and radio as well as phono pick-ups and record players.

Sold separately for \$6.50—or see big MONEY-SAVING COMBINATION OFFER IN COUPON.

2 Troubleshooting & Repair

by Ghirardi & Johnson
822 pages, 417 clear illustrations, \$6.75

Backed by the how-to-do-it methods and procedures so clearly explained in this big book, you can breeze through television and radio service jobs easier and faster than you may have thought possible!

Throughout its 822 pages, *Radio & Television TROUBLE-SHOOTING AND REPAIR* is an amazingly complete, how-to-do-it guide to professional service methods . . . the kind that help you handle jobs lots faster and make more money doing it!

For beginners, this big book is an easily understood course in locating troubles fast and repairing them r-i-g-h-t. For ex-

perienced servicemen, it is a quick way to "brush up" on specific jobs; to develop better methods and shortcuts; or to find fast answers to tough service problems.

Modern troubleshooting is clearly explained—from quick "static" tests to dynamic signal tracing and all the rest. Special hard-to-fix troubles are fully covered. Step-by-step charts demonstrate exactly what to do on different operations. A big television section includes everything you need to know for fast, accurate work on any TV receiver model or make.

Sold separately for \$6.75. Save money by ordering the SPECIAL COMBINATION offer. Send coupon today. Practice 10 days FREE!

SAVE MONEY ON INSTRUMENTS!



BASIC ELECTRONIC TEST INSTRUMENTS
234 pages,
171 illus.,
Price \$4.00

Work better with fewer instruments—get more work out of your old ones

Here, at last, is an instrument book especially for servicemen, amateurs and experimenters!

Basic Electronic Test Instruments helps you work better and faster with fewer instruments; shows how to increase the usefulness of old instruments; how to choose the right instrument for each job; how to understand instrument readings and put them to practical use; how to avoid buying unnecessary instruments . . . and lots more.

Over 60 instruments from the old standbys to the very latest ones are fully described and explained. Work-saving shortcuts are outlined.

Included are complete details on simple meters for current and voltage; ohmmeters and V-O-M's, V-T voltmeters; power meters; impedance meters; capacitor checkers; inductance checkers; special-purpose bridges; oscilloscopes; R-F test oscillators; signal generators; audio test oscillators; R-F and A-F measuring devices; signal tracers; tube testers and many others.

This handy book is a complete training course in the latest instruments including grid-dip oscillators, TV sweep and marker generators; TV linearity pattern generators, square wave generators, distortion meters, etc. Dozens of time-saving "tricks" help you put old instruments to new uses.

Check Basic Electronic Test Instruments in coupon for 10-day FREE trial.

BE AN EXPERT ON MAGNETIC RECORDING!

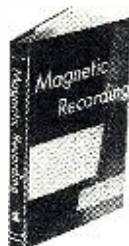

MAGNETIC RECORDING
by S. J. Begun
242 pages, 146 illustrations
Price \$3.00

This how-to-do-it book makes it easy to specialize in one of the fastest-growing electronic fields

There's a real future for men who specialize in the fast-growing field of magnetic recording in any of its many branches!

From high fidelity sound to broadcasting, to sound movies, industrial communications, secret communications (speech scrambling), amateur radio, industrial sound and noise measurements and many others, magnetic recording is now an important factor. This book, *Magnetic Recording*, by one of the nation's acknowledged experts, clearly explains all details of the art.

A COMPLETE GUIDE TO RECORDING METHODS AND EQUIPMENT

First you get a clear understanding of every phase of wire and tape recording . . . from basic acoustic and magnetic theories to components, equipment and circuits in present day use. Subjects include Acoustic Factors; Magnetism; Magnetic Recording Theory and Practice; System Components; Magnetic Recording Equipment; Magnetic Recording Applications; Instrumentation and Recording Measurements; The Magnetic Phonograph, and many more.

Read it 10 full days at our risk. Order Magnetic Recording in coupon.

SHORT CUT TO TELEVISION REPAIRS

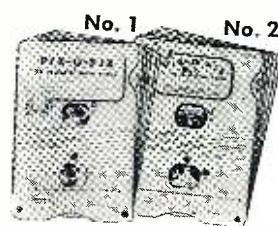

PIX-O-FIX TV TROUBLE FINDER GUIDES
Only \$2 for the two

Eliminate useless testing . . . Fix sets twice as fast!

Just turn the dial of the handy, pocket-size Ghirardi & Middleton PIX-O-FIX TV Trouble Finder Guide. When the picture in the PIX-O-FIX window matches the screen image on the television set you're

repairing . . . presto! . . . you've got your clue. PIX-O-FIX then shows the causes of the trouble. Next it indicates the exact receiver section in which the trouble has probably happened. Then it gives step by step repair instructions.

The two PIX-O-FIX units No. 1 and No. 2 cover 47 different television troubles . . . just about anything you're likely to be called on to fix. No. 1 identifies 24 of the most common troubles and gives 192 causes and 253 remedies for them. No. 2 covers 23 more advanced troubles not included in No. 1. Together, they are a comprehensive guide to quick "picture analysis" servicing of any TV set . . . AND THE PRICE IS ONLY \$2.00 for the two. Money refunded if you are not more than satisfied. Specify PIX-O-FIX in coupon.

USE COUPON FOR 10-day Free Trial!

RADIO EVER MADE

**FAST!
EASY!
R-I-G-H-T!**

Cash in on HIGH FIDELITY SERVICE and CUSTOM-BUILDING!



HIGH FIDELITY TECHNIQUES
By John H. Newitt
Staff, Mass. Inst. of Technology
494 pages, 203 illus.
Price \$7.50

ANSWERS YOUR HI-FI QUESTIONS

... Helps you get top notch results!

Here are just a few of the many subjects: How to get the right hi-fi equipment for your needs; Hi-fi versus P.A. type speakers; Loud-speaker construction and performance; Adjusting bass-reflex cabinets; Controlling distortion; Getting rid of "hangover"; The best reproducer enclosure; Selecting a woofer-tweeter; Sound-proofing materials; All about output transformers; Special hi-fi circuits; Ways to suppress noise; Negative feedback and how to use it; Amplifier construction hints; Minimizing tuner distortion; Avoiding chatter; Limiter-discriminator vs. ratio detector FM circuits; All about records and record players; Avoiding record wear; Tips for custom builders; Bass-reflex calculations and design charts; Acoustical horn design data; special installation problems; pre-amps and equalizers; pick-up resonance and how to avoid it; a novel horn system . . . and literally dozens of other subjects.

Order High Fidelity Techniques in coupon today for 10-day FREE trial!

Get better results from "Hi-Fi" by having all the facts and latest ideas at your fingertips!

This big, brand new book by one of the nation's experts, brings you the complete "low down" on modern sound reproduction methods and equipment. It shows how to get better results at lower cost; how to build your own; how to service hi-fi equipment; discusses all details of components; compares different methods —AND IS CRAMMED FULL OF HOW-TO-DO-IT TIPS AND IDEAS.

GET MORE WORK out of YOUR OSCILLOSCOPE!

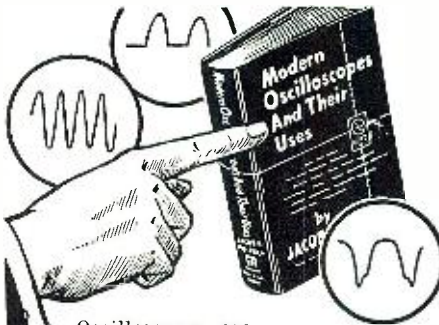

Oscilloscopes are "gold mines" for servicemen who learn to use them fully—and here is a book that **REALLY SHOWS YOU HOW.**

In clear, easily understood terms, *Modern Oscilloscopes and Their Uses* explains when, where and how to use the oscilloscope . . . how to interpret patterns . . . how to use your scope to handle all sorts of jobs easier, faster and better.

No complicated theory! This book gets right down to "brass tacks" in showing how oscilloscopes operate. Then you see exactly how to use them in lab work and on all types of AM, FM and television service . . . from locating troubles to handling tough alignment jobs easier and in lots of time.

A complete guide to the HANDIEST INSTRUMENT OF THEM ALL!

Each operation is made as simple as A-B-C. You learn where and how to use the 'scope on specific jobs; how to make connections; how to adjust circuit components, how to set the controls . . . and HOW TO ANALYZE PATTERNS. 370 illustrations including dozens of pattern photos make things doubly clear.

Practice from it 10 days FREE. Order Modern Oscilloscopes in coupon.

MODERN OSCILLOSCOPES AND THEIR USES

By J. H. Ruiters, Jr., of Allen B. Du Mont Laboratories, Inc.
326 pages, 370 illus.
Price \$6.00

DON'T THROW OLD RADIOS AWAY!



By **A. A. GHIRARDI**
Covers every model made by 202 mfrs. from 1925 to 1942

- Airline
 - Apex
 - Arvin
 - Atwater Kent
 - Belmont
 - Bosch
 - Brunswick
 - Clarion
 - Crosley
 - Emerson
 - Fada
 - G-E
 - Kolster
 - Majestic
 - Motorola
 - Philco
 - Pilot
 - RCA
 - Silvertone
 - Sparton
 - Stromberg
- ... and over a hundred more!

Let this big Handbook show you **EXACTLY HOW TO FIX THEM** fast and r-i-g-h-t

There's a "secret" to fixing old radios fast and profitably . . . and Ghirardi's big 744-page, manual-size **RADIO TROUBLESHOOTER'S HANDBOOK** is it!

No other guide like it! Gives common trouble symptoms and remedies for over 4,800 models of old home receivers, auto radios and record changers. Contains tube and component data, charts, circuits, etc. available from no other source.

Even beginners can repair old sets that dealers say should be thrown away because service data is lacking. Just look up the model you want to fix. Four times out of 5, this giant Handbook leads you right to the trouble . . . shows exactly how to fix it. No useless testing. No guesswork. You repair sets in a jiffy that would otherwise go to the junk pile.

There are over 400 pages of troubleshooting and service case histories. In addition, you get over 300 pages of helpful I-F transformer data; superhet realignment data and alignment peaks; handy troubleshooting reminder charts; auto radio gear ratios; complete data and characteristics on old tube types and components; tube substitution data . . . and dozens of other invaluable service tips and ideas. Price only \$6.50.

Specify **RADIO TROUBLESHOOTER'S HANDBOOK** in coupon for 10-day FREE trial.

Send No Money!
TRY ANY BOOK
TO FULL DAYS FREE!

Here's How to BREAK INTO RADIO-ELECTRONICS!

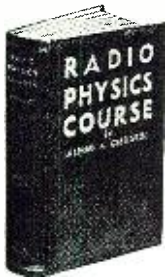

RADIO PHYSICS COURSE
by Ghirardi
972 pages, 508 illus.
856 self-test questions
Price only \$6.50

More people now in Radio-Television-Electronics got their basic training from this book than any other of its type!

"The most complete training course in radio fundamentals ever offered!" . . . that's what the experts say about Ghirardi's world-famous **RADIO PHYSICS COURSE** book. More widely used in World War II military training and for home study than any other basic text.

RADIO PHYSICS COURSE is the oldest text of its kind on the market—and still a "best seller" because it is so complete, clear and easy to understand, even without any previous radio training. You can buy newer and far more costly training—but you can't buy better training at anywhere near the price. Ask the men who know!

Starts right at the beginning with Basic Electricity. Then it takes you step by step through the entire field from circuits showing basic functions to the final applications of these circuits in radio-electronic equipment.

Study from it for 10-full days. Specify **RADIO PHYSICS COURSE** in coupon.

Dept. RN-15, Rinehart & Company, Inc.,
232 Madison Ave., New York 16, N. Y.

Check here for **MONEY-SAVING COMBINATION OFFER . . .**

. . . on Ghirardi's Radio & TV Receiver **CIRCUITRY AND OPERATION**, and Radio & TV Receiver **TROUBLESHOOTING AND REPAIR**. Price only \$12.00 for the two books plus postage. (Regular price \$13.25 . . . you save \$1.25). Payable at rate of \$3 after 10 days and \$3 a month for three months until \$12 has been paid. If not satisfactory, return books in 10 days and owe nothing.

Check here to order **INDIVIDUAL BOOKS**

- Radio & TV Receiver **CIRCUITRY & OPERATION** . . . \$6.50
- Radio & TV Receiver **TROUBLESHOOTING & REPAIR** . . . \$6.75
- BASIC ELECTRONIC TEST INSTRUMENTS** . . . \$4.00
- MAGNETIC RECORDING** . . . \$5.00
- PIX-O-FIX TROUBLE-FINDER GUIDES (Nos. 1 and 2)** . . . \$2.00
- HIGH FIDELITY TECHNIQUES** . . . \$7.50
- MODERN OSCILLOSCOPES AND THEIR USES** . . . \$6.00
- RADIO TROUBLESHOOTER'S HANDBOOK** . . . \$6.50
- RADIO PHYSICS COURSE** . . . \$6.50

If cash is sent with order, we pay postage—same 10 day return privilege. Otherwise, postage is extra.

To order **OUTSIDE U.S.A.**—Special combination offer. \$13.00 for both books. For all other books, add 50c each to above prices for handling through customs, etc. Sold for cash only. Any book may be returned in 10 days and money will be refunded.

Name

Address

City, Zone, State

for **ALL METERS**
ALL RANGES



Make safe, accurate high-voltage measurements with any voltmeter, multi-meter, or VTVM having sensitivities of 10,000 ohms-per-volt or more.

The new Boland & Boyce Universal High-Voltage Probe can be used with different instruments for dozens of ranges . . . and it is safe and easy to use in the bargain. Complete with 4 plug-in precision resistors and instructions for matching virtually any meter . . . any range—10KV, 30KV, 60KV, and intermediate ranges. Clear, high-dielectric handle shows resistors in use. Includes shielded cable with Amphenol connectors. B&B MODEL 702 HV PROBE—\$12.95 net.

TEST C-R TUBES & CIRCUITS under receiver's own power



Measure both TV picture tube or receiver performance in one all-inclusive test! Two cabled leads of B&B C-R Tube Tester connect between tube and receiver.

8-position switch tests: grid-cathode, heater-cathode, and grid-screen leakage; grid cathode voltages; receiver screen and video output voltages; beam current at HV anode; grid control of beam; effect of brightness and contrast controls; and much more.

Instantly isolates tube or receiver faults. Separate plug-in power supply available for in-carton tube testing. Prices include 2 cabled leads and instruction manual, KIT—\$29.95. FACTORY WIRED & TESTED—\$39.95. Sold by leading distributors.

New! B&B Model 704 BIAS BOX



An exact, steady source of d-c bias voltage, 0 to 17 volts. A "must" for radio and TV realignment. Clips and grounds to chassis apron; connects to nearest 6.3-V heater voltage terminal. Kit only \$6.95. Assembled, wired and tested, \$9.95.

Write for brochure describing B&B products.

BOLAND & BOYCE, Inc.

Dept. RN-15, 236 Washington Avenue
Belleville 9, N. J.

Within the INDUSTRY

LEON A. WORTMAN has been appointed sales manager of the *J. C. Warren Corporation* of Freeport, New York.

Prior to taking his new post, Mr. Wortman was national advertising and sales promotion manager for *RCA's* magnetic tape recorders and high-fidelity components. He was also formerly director of advertising and sales promotion for the *Audio & Video Products Corporation*, *Audio-Video Recording Company*, *A-V Tape Libraries*, *Magna-Crest Corporation*, and *Fairchild Recording Equipment Corporation*.

In his new position, he will be in charge of the firm's sales program, including marketing, advertising, and sales promotion efforts.



ROBERT J. MUELLER has been appointed vice-president in charge of sales for the *Walsco Electronic Corporation* . . .

FRANK GANSON has been named chief engineer of the transformer division and **GEORGE ZIMMERMAN** is a new sales engineer for *Oxford Electric Corp.* . . . *Carter Parts Company* has announced that **BRUCE E. VINKEMULDER** has joined the firm as sales manager of its electronic division . . . **JACK POWERS** is the new sales manager of *Edwin I. Guthman & Co., Inc.* . . . **DAVE SILVERBERG**, San Francisco district sales manager for *Pioneer Electronics Corp.*, passed away recently at the age of 32 . . . **DONALD F. MIERSCH** is the new general sales manager for *Sparton Radio-Television*. He replaces **B. G. HICKMAN** who has resigned that post to take on a special assignment for the company . . . **DR. ELMER W. ENGSTROM** has been elected to the board of directors of *Radio Corporation of America*, filling the vacancy caused by the retirement from the board of **WALTER A. BUCK** . . . **O. O. SCHREIBER**, assistant to the president of *Philco* for the past four years, has

been named a vice-president of the firm . . . **BRIG. GEN. JAMES S. WILLIS, USA** (ret.), has joined the *Hallcrafters Company* as coordinator of research and development . . . **WILLIAM W. GARSTANG** has been named chief engineer of the radio division of *Allen-Bradley Company* . . . **ELTON T. BARRITT** has been elected president of *CGS Laboratories, Inc.* of Stamford, Conn. . . . **H. J. ALLEN**, field sales manager for appliances, has been named general sales manager of the *Crosley radio and television division* . . . **LEE SCHOENFELDT** is the new marketing research manager for *General Electric's* radio and television department in Syracuse . . . **FRANK T. GAIN** has been appointed sales manager of *Air-design, Incorporated* . . . **M. C. THOMSEN** has joined *Wilcox-Gay Corporation* as executive vice-president . . . Election of **JOHN W. CRAIG** as vice-president and general manager of the *RCA Victor* home appliance division has been announced by *Radio Corporation of America* . . . **RICHARD F. BREMAN** has been named quality control manager for *Permoflux Corporation* . . . **NORMAN LORBER** is the new director of public relations for *Chromatic Television Laboratories* . . . **FRED OKON** has been promoted to advertising manager of *CBS-Columbia* . . . **IVOR BOWEN**, principal director of air equipment research and development in Great Britain's Ministry of Supply, has resigned his post to become British Empire representative of *General Precision Equipment Corporation*. He will headquarter in London . . . **STANLEY KRAMER** has been appointed assistant sales manager of the *Semi-Conductor Division of Radio Receptor Co., Inc.*

H. M. CARPENTER, owner of *Thurrow Distributors, Inc.* of Tampa, Florida, has been elected president of the National Electronic Distributors Assn.

Serving with Mr. Carpenter are Aaron Lippman, re-elected chairman of the board; Lewis J. Bonn, first vice-president; Frank Kearns, second vice-

SIMON WEXLER, founder and vice-president of *Allied Radio Corporation*, passed away suddenly of a heart attack in his office. He was 56 years of age.

Mr. Wexler, well-known in the electronics industry, started in radio in 1921, the first year of commercial radio broadcasting. His company, the *Columbia Radio Corporation*, was among the first manufacturers of crystal sets and such components as variometers, vari-couplers, and

honeycomb coil tuners, used in the radio kits of the day.

Allied was organized as distributors for the increasing number of parts manufacturers. Over the succeeding years, Mr. Wexler, although devoting time to other interests as well, made a major contribution in developing *Allied* to its present size.

He is survived by his widow, three sons, a daughter, seven grandchildren, three sisters, and two brothers.

GET IN ON THE BOOM!



L. C. Lane, B.S., M.A.
President, Radio-Television Training Association. Executive Director, Pierce School of Radio & Television.

TRAIN FOR A HIGH PAYING JOB AS A TELEVISION TECHNICIAN
NO PREVIOUS EXPERIENCE NEEDED — study AT HOME in your SPARE TIME

Next to the atom and hydrogen bombs, the biggest noise being made today is by the booming radio-television-electronics industry.

Now, while the boom is on in full force, is the time for you to think about how you can share in the high pay and good job security that this ever-expanding field offers to trained technicians.

Just figure it out for yourself. There are more than 400 television broadcasting stations operating right now

and hundreds more to be built; more than 30 million sets in the country and sales increasing daily. By 1955 moderately priced color television sets will be on the market and the color stampede will be on.

All these facts mean that good jobs will be looking for good men. You can be one of those men if you take advantage of my training now — the same training that has already prepared hundreds of men for successful careers in the radio-television-electronics field.

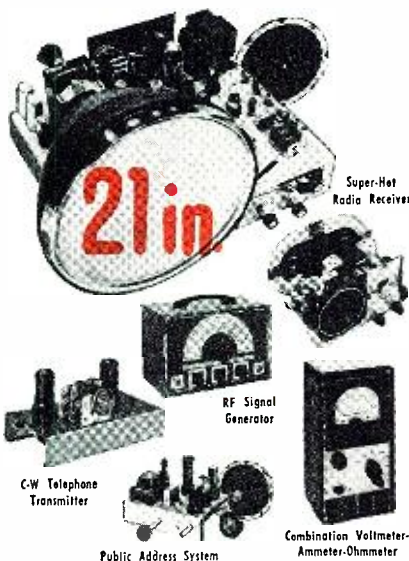

No experience necessary! You learn by practicing with professional equipment I send you. Many of my graduates who now hold down good paying technician jobs started with only grammar school training.

If you have previous Armed Forces or civilian radio experience you can finish your training several months earlier by taking my FM-TV Technician Course. Train at home with kits of parts, plus equipment to build BIG SCREEN TV RECEIVER. ALL FURNISHED AT NO EXTRA COST!

After you finish your home study training in the Radio-FM-TV Technician Course or the FM-TV Technician Course you get two weeks, 50 hours, of intensive Laboratory work on modern electronic equipment at our associate school in New York City, Pierce School of Radio & Television. THIS EXTRA TRAINING IS YOURS AT NO EXTRA COST WHATSOEVER. My courses are complete without this extra training, however. It is just an added opportunity for review and practice.

**RADIO-FM-TV
TECHNICIAN
TRAINING**

**FM-TV
TECHNICIAN
TRAINING**

**EXTRA
LABORATORY
TRAINING IN
NEW YORK
CITY
AT NO EXTRA
COST!**

VETERANS!

My School fully approved to train veterans under new Korean G.I. Bill. Available only to Veterans discharged in past 36 MONTHS.

LEARN BY DOING As part of your training, I give you enough equipment to set up your own home laboratory and prepare for a BETTER PAY TV job. You build and keep a professional GIANT SCREEN TV RECEIVER complete with big picture tube (designed and engineered to take any size up to 21-inch) . . . also a Super-Hot Radio Receiver, RF Signal Generator, Combination Voltmeter-Ammeter-Ohmmeter, C-W Telephone Transmitter, Public Address System, AC-DC Power Supply. Everything supplied, including all tubes.

EARN WHILE YOU LEARN Almost from the very start you can earn extra money while learning by repairing radio-TV sets for friends and neighbors. Many of my students earn up to \$25 a week . . . pay for their entire training from spare time earnings . . . start their own profitable service business.

FREE FCC COACHING COURSE Qualifies you for Higher Pay! Given to all my students AT NO EXTRA COST. Helps you qualify for the TOP JOBS in Radio-TV that demand an FCC license! Full training and preparation at home for your FCC license.

Radio **T**elevision **T**raining **A**ssociation
52 EAST 19th STREET • NEW YORK 3, N. Y.

Licensed by the State of New York • Approved for Veteran Training
January, 1955

**YOU GET
THESE FOUR
Free!**



MAIL THIS COUPON TODAY!
no salesman will call!

Mr. Leonard C. Lane, President
RADIO-TELEVISION TRAINING ASSOCIATION
52 East 19th Street, New York 3, N. Y. DEPT. T-1

Dear Mr. Lane: Mail me your NEW FREE BOOK, FREE SAMPLE LESSON, and FREE aids that will show me how I can make BIG MONEY IN TELEVISION. I understand I am under no obligation and no salesman will call.

(PLEASE PRINT PLAINLY)

Name _____ Age _____

Address _____

City _____ Zone _____ State _____

I AM INTERESTED IN:

- Radio-FM-TV Technician Course
- FM-TV Technician Course
- TV Cameraman & Studio Technician Course

VETERANS!

Give date of discharge _____

The Sensation of Two Audio Fairs . . .



PERMOFLUX

Largo and Diminnette

2-WAY SPEAKER SYSTEMS



Now Available Under

HTP*

Acclaimed at the Sight and Sound Exposition in Chicago and the Auditorama in New York, these amazing high-fidelity speaker systems are now available under HTP—an exclusive Permoflux insured plan that enables you to try a Largo or Diminnette in the quiet and comfort of your own home for 15 days. See your hi-fi dealer today!

***EXCLUSIVE PERMOFLUX 15-DAY INSURED HOME TRIAL PLAN, INTRODUCED AT THE CHICAGO AND NEW YORK AUDIO FAIRS, OCT., 1954**

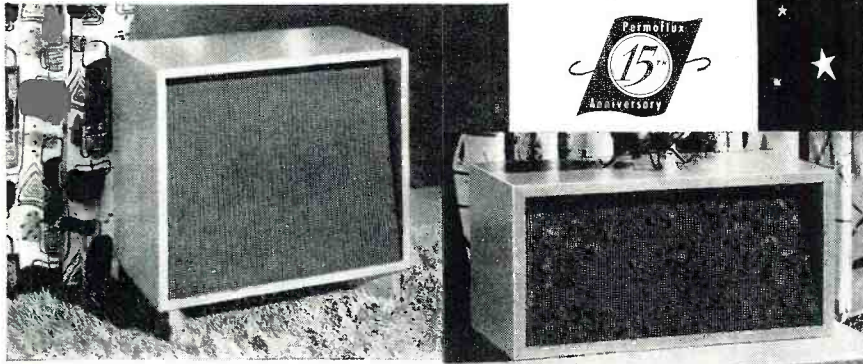

THE LARGO

Outstanding wide-range speaker system at moderate cost. Uses the "Super Royal Eight" speaker and Super Tweeter. Unique new-type back-loading horn enclosure is matched, octave by octave, to speakers . . . assuring undistorted reproduction from 35-16,000 cps. In selected 3/4" Mahogany or Korina veneers. Exclusive: Special connection for headset extension cord. Size: 24" W, 23" H, 14" D. Impedance, 8 ohms. Suggested Audiophile Net . . . **\$99.75**

THE DIMINETTE

A marvel of compactness featuring "big-system" reproduction over the full audio range and low cost. Ideal for use in a bookcase or as extension speaker. With 2 "Royal 6" speakers and Super Tweeter. In Mahogany or Blonde finish 3/4" Veneers. Size: 23 1/2" W, 11 1/2" H, 12" D. Impedance, 4-8 ohms. Suggested Audiophile Net . . . **\$49.50**
As above, but with selected 3/4" Mahogany or Korina veneers. Suggested Audiophile Net . . . **\$64.50**

HEARING IS BELIEVING! Try either system at home under HTP! Read what High-Fidelity Magazine says:

"It's best to try a speaker at home before buying."
—Audio Forum Dept., Oct. 1954 issue

FOR A LIMITED TIME ONLY: Every HTP participant will receive, absolutely FREE, the new Permoflux "Maestro" Speaker-Headset Control Box. See your Permoflux-authorized HTP dealer, or write for full details, to:

Permoflux CORPORATION
4918 West Grand Avenue • Chicago 39, Illinois

West Coast Plant • 4101 San Fernando Road • Glendale 4, California
Canadian Licensee • Campbell Manufacturing Co., Ltd., Toronto, Canada

president; R. C. Whitehead, re-elected treasurer; and Albert Steinberg, re-elected secretary.

* * *

JAMES F. WHITE, formerly with CBS-Columbia as contracts division manager, has been appointed general sales manager in charge of all phases of the sales effort at Crescent Industries, Inc.



Prior to joining CBS-Columbia in 1949, Mr. White was general manager of Gray Audograph and prior to that was associated with Andrew Corporation.

As a graduate engineer in electrical engineering from Yale University in 1940, Mr. White saw active duty as an officer with the 7th Fleet and during 1945 and 1946 was assigned to the M.I.T. Radiation Laboratory as project engineer in charge of research that developed the special radar used for detecting guided missiles.

* * *

ELGIN NATIONAL WATCH COMPANY has entered the West Coast electronics manufacturing field with the outright purchase of **NEOMATIC, INC.**, manufacturers of miniature electronic components . . . **WATERS MANUFACTURING, INC.** has purchased the assets and facilities of **AEROHM CORPORATION**. Both firms manufacture potentiometers and the units of both firms will be sold under the trademark "Aerohm" . . . **YALE INDUSTRIES CORP.**, manufacturers of tape splicers, has changed its corporate name to **ROBINS INDUSTRIES CORP.** The firm's address and all other aspects of the business remain the same.

* * *

WILLIAM H. SHAW has been appointed national service manager in charge of all service operations for the *Hallcrafters Company*.



For a year and a half prior to his appointment to the newly-created post, Mr. Shaw had been general sales manager of *H.M.S. Distributors* of Los Angeles. Before this, he was district sales manager for the western division of *Hallcrafters* and western regional field engineer for the same firm.

Before joining *Hallcrafters*, he was sales engineer for *Taylor Tubes, Inc.* He attended Northwestern University and Illinois Institute of Technology.

* * *

ADMIRAL CORPORATION has broken ground for a fourth addition to its television plant in Harvard, Illinois. The addition consists of 65,000 square feet and will increase the total plant area in Harvard to over 187,000 square feet . . . **TRAVLER RADIO CORPORATION** has opened a factory-distributing branch at 1251 Folsom Street in San

(Continued on page 171)

RADIO & TELEVISION NEWS

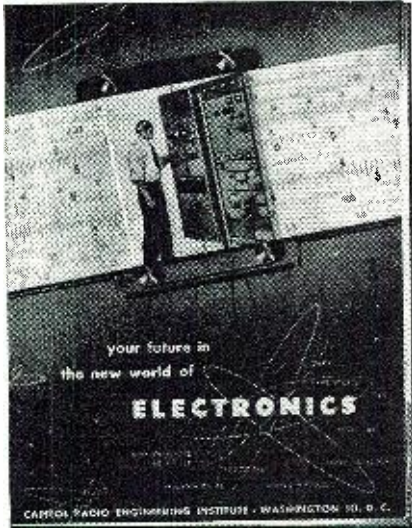

The data that Launched
Thousands of Careers
is yours FREE to show

**HOW YOU CAN BE SUCCESSFUL
IN RADIO-TV-ELECTRONICS**

Send for Your Booklet Today!

YOU CAN plod along for years, getting a paltry increase now and then, enjoying little security, finding your work dull and drab.

Then something happens. Things look up. You become more confident. Your earnings rise. You feel more important.

"Luck," some may say.

"Contacts," others may suggest.

But in your heart, you will know the answer: "Training." And it all may have started the moment you filled out a coupon requesting a copy of a free booklet named "Your Future in the New World of Electronics." From this data you get knowledge of where you stand in Electronics. Tremendous expansion leaves this gigantic industry pleading for trained men. Top manufacturers sold billions of dollars worth of electronic merchandise in 1953. By 1960, the radio-electronics industry should do no less than 10 billion dollars per year, not counting military orders.

Today there are over 97,000 radio-equipped police cars; an even larger number of taxis are radio equipped (at least 87,000); 32,000 civilian planes have radio; 35,000 American ships have radio.

Today there are over 120,000,000 radios in use. There are 28,000,000 TV sets and 381 TV stations in operation. Color TV is coming into its own. Countless positions must be filled—in development, research, design, production, testing and inspection, manufacture, broadcasting, telecasting and servicing. To fill these posts, trained men are needed—men who somewhere along the line take time to improve their knowledge, their skills. Men who, today, perhaps, take two minutes to send for a booklet.

"Your Future in the New World of Electronics" shows you how CREI Home Study leads the way to greater earnings through the inviting opportunities described above.

However, CREI does not promise you a "snap." With an accredited technical school such as this, you must *study* to convert your ambition into technical knowledge you can sell in the fabulous Electronics market.

Since its founding in 1927, CREI has provided thousands of professional radio men with technical educations. During World War II CREI trained thousands for the Armed Services. Leading firms

choose CREI courses for group training in electronics, at company expense, among them United Air Lines, Canadian Broadcasting Corporation, Trans-Canada Airlines, Sears, Roebuck and Co., Bendix Products Division, All-American Cables and Radio, Inc., and Radio Corporation of America.

CREI courses are prepared by recognized experts in a practical, easily understood manner. You get the benefit of time-tested materials, under the personal supervision of a CREI Staff Instructor, who *knows* and *teaches* you what industry wants. This is accomplished on your own time, during hours selected by you, and controlled by your own will power. This complete training is the reason that graduates find their CREI diplomas keys-to-success in Radio, TV and Electronics. CREI alumni hold top positions in America's leading firms. At your service is the CREI Placement Bureau, which finds positions for advanced students and graduates. Although CREI does not guarantee jobs, requests for personnel far exceed current supply.

Now is the time of decision for you. Luck will not propel you forward unless it finds you trained. Contacts won't budge you an inch unless you have the skill to back them up. The answer is: Technical Training . . . and willingness to learn. Together they will bring you increased earning in this new

Age of Electronics. Fill out the coupon below and mail it now. We'll promptly send you your free copy of "Your Future in the New World of Electronics." The rest—your future—is up to you.

CREI resident instruction (day or night) is offered in Washington, D.C. New classes start once a month.
VETERANS: If you were discharged after June 27, 1950—let the new G.I. Bill of Rights help you obtain CREI resident instruction. Check the coupon for full information.

MAIL THIS COUPON Today!

CAPITOL RADIO ENGINEERING INSTITUTE
ECPD Accredited Technical Institute Curricula
Dept. 111-B, 3224 16th St., N. W., Washington 10, D. C.

Please send me your course outline and **FREE** Illustrated Booklet "Your Future in the New World of Electronics" . . . describing opportunities and CREI home study courses in Practical Electronics Engineering.

- CHECK FIELD OF GREATEST INTEREST**
- Practical Radio Engineering
 - Broadcast Radio Engineering (AM, FM, TV)
 - Practical Television Engineering
 - Aeronautical Electronics Engineering
 - TV, FM & Advanced AM Servicing

Name

Street

City..... Zone..... State.....

CHECK: Residence School Veteran

To help us answer your request intelligently, please give the following information:

EMPLOYED BY.....

TYPE OF PRESENT WORK.....

SCHOOL BACKGROUND.....

ELECTRONICS EXPERIENCE.....

IN WHAT BRANCH OF ELECTRONICS ARE YOU MOST INTERESTED?

LAFAYETTE'S SPECTACULAR MULTITESTER VALUE!

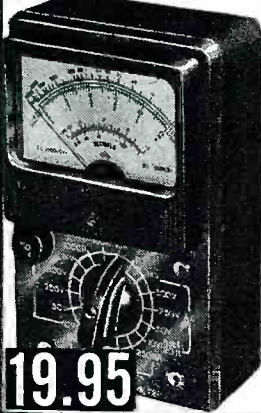

**HIGH SENSITIVITY
AC-DC MULTITESTER**
20,000 ohms per Volt

The new Lafayette High Sensitivity Multitester is a complete instrument (not a kit). Here is an instrument plays with every desirable feature found only in instruments costing twice as much. One of the most sensitive multitesters ever offered. 20,000 ohms per volt DC; 8,000 ohms AC, having a high sensitivity 45 microamps meter. Full scale AC-DC voltage ranges are 0-10V, 0-50V, 0-250V, 0-500V, 0-1,000V; DC current ranges 50 microamps, 2.5 ma, 25 ma, 250 ma. Resistance: 0-5K ohms, 0-50K ohms, 0-500K and 0-5 megohms. Decibel range: -20 +5 db; +5 +22 db (0 db -0.775V - 600 ohms). Extreme versatility and accuracy. 1% precision resistors; 3" meter; beautiful plastic front, with metal bottom for ruggedness. Size: 3 3/4" x 5 1/2" x 2 1/2". Complete with batteries and leads. Shpg. Wt. 4 lbs.

19.95

RW-30G NET 19.95
In lots of 3 19.25

**NEW POCKET AC-DC
VOM MULTITESTER**
1,000 ohms per Volt

This instrument is one of the best buys that Lafayette has ever offered in a Wide Range AC-DC MULTITESTER. An ideal portable unit that meets the need for a compact, yet rugged test instrument. Has ease of operation usually FOUND ONLY IN MORE EXPENSIVE INSTRUMENTS. Has 1000 ohms/volt sensitivity on both AC or DC. Uses full 3" rectangular meter with large easy to read scale. Uses 1% precision resistors, jeweled D'Aronval microamp meter movement. Ranges: AC-DC and output volts 0-5, 0-25, 0-250, 0-1000V; DC current 0-1, 0-10, 0-100, M.A.; Resistance 0-10K and 0-100K ohms. In handsome sturdy bakelite case. Size: 4 3/4" x 3 1/4" x 1 1/2". Supplied Complete with test leads and batteries. A Must for every serviceman, shop, Laboratory or experimenter—and at Lafayette's Price you can afford to own one. Shpg. Wt. 2 1/2 lbs.

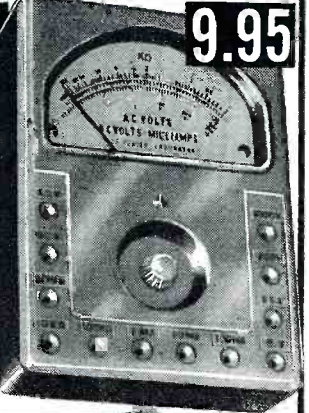

9.95

MODEL RW-27C—Complete
In Lots of 3 9.45
Single, ea. 9.95

Collaro

**THE WORLD'S FINEST 3 SPEED
AUTOMATIC RECORD CHANGER**

SPECIAL **29.50** LIST PRICE **54.50**

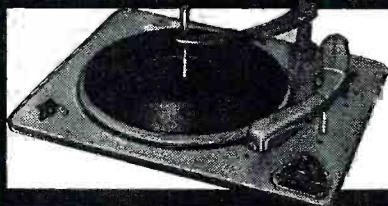

Lafayette scores again with an almost unbelievable price on the Collaro 3-speed Automatic record changer. We made a spectacular buy and we are passing the savings on to you. Here's the finest changer made. Manufactured in England—with a world-wide reputation. It plays all sizes and all speeds automatically. It's packed with quality features that the Hi-Fidelity enthusiast will appreciate: Jam-proof ball bearing mounted tone arm; automatic shut-off after last record; powerful fan cooled hum-shielded 4-pole motor with self-aligning oilite bearings; automatic muting switch; weighted ball-bearing mounted constant speed turntable; rubber drive couplings—and more! Base size 14 1/2" x 12 1/2". Depth below base 2 1/2". Shpg. Wt. 19 lbs. Available either less cartridge with plug-in shell, or with famous turnover Ceramic or G.E. Triple-Play cartridge.

COLLARO Model 3/531 changer Net 29.50
COLLARO Model 3/531 with Turnover Ceramic cartridge Net 31.50
COLLARO Model 3/531 with G.E. Triple Play RPX-050 cartridge installed Net 32.50
45 RPM SPINDLE

Slips on in place of regular spindle, eliminating use of center inserts on 45 RPM records.
GSA Spindle Net 3.23

COMPENSATOR

for G. E. CARTRIDGE
Designed for use with G.E. reluctance cartridges and preamplifiers. Five settings include LP, AES, Flat, Good 78 and Poor 78. No circuit loss is produced by use of equalizer. A must where greater bass and treble response is desired. Flat position gives maximum high frequency response. No wiring required—just plug in. With lead and plug. 2 1/2" x 2" x 2"—Max. depth 4".
Stock No. PK-60 NET 4.95



DUAL STYLUS — TRIPLE PLAY

**DIAMOND and
SAPPHIRE**
(LP) (78)
LIST \$31.00
Replacement for All G.E.
RPX-050 Triple-Play Cartridges
Stock No. PK-29 Net 11.95

TIMER-SWITCH SALE

Automatically turns on radios, television sets, toasters, coffee makers, etc.—at any pre-set time within 12 hour period; also tells time. Built-in single-pole switch handles up to 15 amps, 115 volt. Requires 3/2" diameter round hole. Depth behind dial face 3/4". Shpg. Wt. 1 1/2 lbs. MS-62, for 110V/60 Cy AC
3.95



Top Quality CRYSTAL MIKE

\$575
• -52 db output level
• Range 30 - 10,000 cps
• 10 ft. cable and locking base
• Handle and interconnector
A really fine microphone by a manufacturer known the world over. Use for amateur broadcasting, public address and home recording. Can be used with floor stand. Shpg. Wt. 2 1/2 lbs.
PA-21 5.75

MINIATURE VOLUME CONTROL

3/4" DIAMETER
Only 3/4" Diameter, overall depth approximately .4" including threaded shaft. Ideal for miniature radio, hearing aids, etc.
VC-18—Range 0-500,000 audio taper.. 39c
VC-19—Range 0 to 1 Meg. linear taper 39c
VC-20—Range 0 to 3 Meg. audio taper 39c
In Lots of 10—\$3.25
39c



PRECISION DRAFTING SET

11 Pieces—Fitted Felt-Lined Case
Made in Germany, of heavy brass, nickel plated and polished. Instruments include 5 1/2" Compass with pencil and pen points and lengthening bar. 5 1/2" Divider, three 3 1/2" sidewheel bow dividers with needle point, pen point and pencil point. 5" Ruling pen, extra handle for pen or pencil, capsule with extra leads. Interchangeability of these many parts makes this an exceptionally versatile set. Your money back—if this set is not worth twice our price!
F-18 Net 2.75



**Lafayette
Greatest Tape Buy Ever!**

1200 FT. REEL
Genuine Plastic Base
RECORDING TAPE
Shpg. Wt. 14 oz.
LAFAYETTE made a terrific deal with one of the leading manufacturers of recording tape to supply you with their regular tape which sells for almost twice our price. WE GUARANTEE ABSOLUTE SATISFACTION OR YOUR MONEY BACK. The finest, professional-quality recording tape obtainable. Highest performance for thousands of playings. Red Oxide Base in a smooth, uniform coating; greater signal strength; with maximum fidelity; uniform frequency response from 40-15,000 cps.
In lots of 10 rolls - 1.75 ea

**LAFAYETTE EXCLUSIVE!
DYNAMIC EAR PHONE**

A new lightweight plastic ear phone especially imported by Lafayette to bring you the high quality of a dynamic ear phone with the ease and comfort of an almost weightless unit—at a price less than half that of any comparable unit. Fits right into ear. Excellent sensitivity of 65 db. Ideal for use with miniature sets, hearing aids, transcribing, etc. DC resistance 2000 ohms, impedance 5000 ohms at 1000 cycles. Complete with 3 ft. plastic covered cord.
EXCELLENT FOR SILENT LISTENING OR VIEWING
Will replace speaker on any radio set or T.V. for silent listening, by direct connection to secondary of output transformer.
MS-72 Net 1.95

**SARKES TARZIAN
VHF TUNER**

Brand new—covers entire VHF spectrum. It is an exact duplicate of thousands now in use in many chassis including the Sylvania 310 and 320 series. Has 7" long concentric shafts. Excellent gain, noise factor, image and I.F. rejection. For 40 mc IF systems. Complete with 6BC6 and 6X4 tubes and shields. Shpg. Wt. 4 lbs. Worth 3 times the price!
TL-24—In lots of 3 each 4.45
Single each 1.49

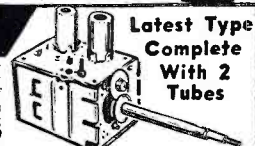

**CARDWELL
UHF CONVERTER SALE!**

List 42.50
Net 13.95 ea.
Lots of 3
Singly 14.45 ea.
Outstanding Value! The Cardwell ES-1 UHF converter covers the entire UHF spectrum—channels 14-83. Has 6AP4 oscillator, 6CB6 IF amplifier and 1N72 crystal diode. Features printed circuit oscillator, high overall gain (3 to 4 times), high sensitivity, constant L/C ratio tuner, 25-1 gear drive. Has AC cord and plug. 3-pos. switch for UHF, VHF and OFF. Handsome wood cabinet 8 1/2 x 6 1/2 x 3 1/4" with easy reading dial. Shpg. Wt. 4 1/2 lbs.
CARDWELL ES-1 Converter—Lots of 3 each 13.95
Singly each 14.45



**5" Tweeter AND
Crossover Network**

A specially designed 5" Tweeter and Crossover Network that will assure high frequency response when used with any speaker you now possess. You can now make your present speaker into a 2-way speaker system increasing the high frequency range up to 15,000 cycles. Diagram included. Shpg. Wt. 5 lbs.
STOCK NO. SY-14 Net 6.95



NEVER BEFORE AT THIS PRICE

**IMPORTED DIRECT
PRISM-COATED
LENSES
BINOCULARS**
• ALL-METAL CONSTRUCTION
• INDIVIDUAL FOCUS
• COMPLETE WITH LEATHER CASE & STRAPS
F-86, 8x30 with case Net 19.95
F-15, 7x35 with case Net 22.50
F-103, 7x50 with case Net 24.95
F-104, 12x50 with case Net 32.50
with order, add 10% Fed. Tax.



**Lafayette
Radio**
DEPT. RA
Write for FREE Bargain Packed Catalog!

Build it Yourself

in 17 minutes...

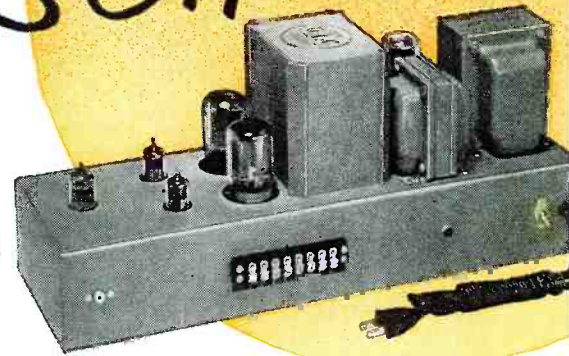

THE 'LINEAR STANDARD' 20-WATT PRE-FAB AMPLIFIER

*Second to None in Quality
and Performance*

Yes, just tighten 17 screws, in 17 minutes, connect your completed UTC Pre-Fab Amplifier into your Hi-Fi system, then sit back and enjoy the most spine-tingling tones you ever heard through your music system. *And all you have used is a screwdriver.*

The UTC 'Linear Standard' is the first pre-engineered, pre-fabricated, pre-assembled amplifier kit ever offered to the home building audio fan, that employs the latest and most advanced techniques including the printed circuit. You needn't know a tube from a condenser, just how to use a screwdriver.

More than a year of top level UTC engineering has gone into this amplifier to produce the cleanest, purest, response you have ever heard. It's absolutely linear: no positive feedback, hence no response peaks at either end of the spectrum. Excellent damping and transient response . . . no hangover on low frequencies to cause boominess . . . no high frequency ringing. In short, just pure, clean, true-to-life response that sounds as good as it tests on the meter.

And it's the **only** amplifier with a feedback circuit so stable that any one of the tubes can be replaced and still be perfectly matched to its twin, with no critical circuit readjustments necessary.

It is the finest amplifier you can own, and you can proudly say, "I built it myself."

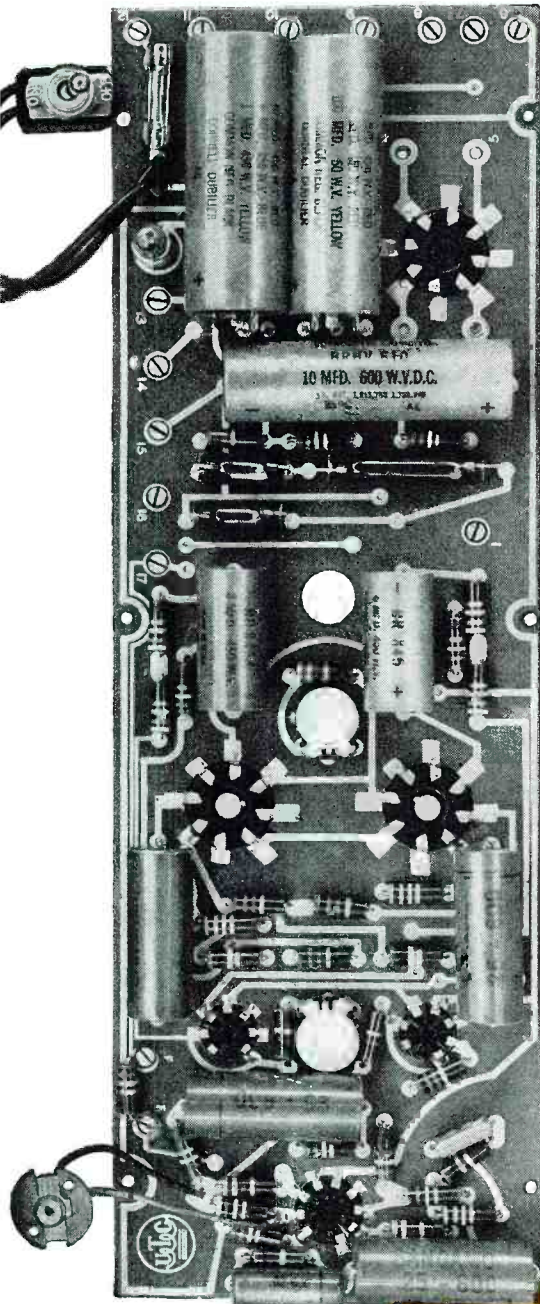

Net
\$108.00



UNITED TRANSFORMER CO.

150 VARICK STREET
www.americanradiohistory.com

NEW YORK 13, N. Y.



"Might As Well Drop Me Off At Walter Ashe"

Whether you visit us personally or resort to other means of contact, you'll find this friendly house of service "right there" with its fabulous money-saving "Surprise" trade-in allowances on your used (factory-built) test and communication equipment. For the deal of your life, drop in, wire, write, phone or use the handy coupon—today!

CENTRAL ELECTRONICS MULTIPHASE SINGLE SIDEBAND EXCITERS



MODEL 10B EXCITER KIT.
10 watts peak output. Net \$129.50.
Wired and tested. Net \$179.50.



MODEL 20A EXCITER KIT.
20 watts peak output. Net \$199.50.
Wired and tested. Net \$249.50.

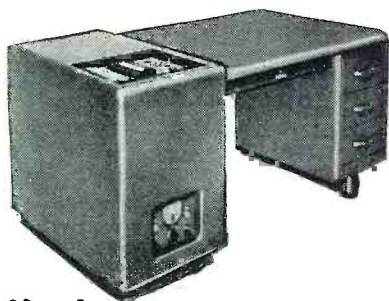

New! JOHNSON VIKING KILO-WATT POWER AMPLIFIER For CW, AM, and SSB. Write for full particulars and get your deal working now for early delivery.



JOHNSON VIKING RANGER TRANSMITTER-EXCITER KIT. Less tubes. Net \$179.50.
Wired and tested. Less tubes. Net \$258.00.
Set of tubes for Ranger. Net \$22.61.

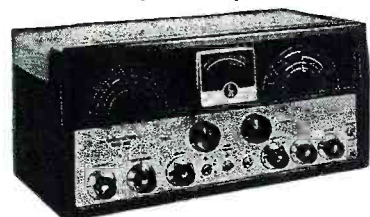

NEW JOHNSON VIKING ADVENTURER.
50 watt CW transmitter kit. Bandswitching, TVI suppressed. With tubes. Net \$54.95.

HALLICRAFTERS SX-96.
Less speaker. Net \$249.95.

All prices f. o. b. St. Louis • Phone CHestnut 1-1125

Walter Ashe
RADIO CO.
1125 PINE ST. • ST. LOUIS 1, MO.

FREE CATALOG!

WALTER ASHE RADIO COMPANY
1125 Pine Street, St. Louis 1, Missouri

Rush "Surprise" Trade-In Offer on my _____
for _____
(show make and model number of new equipment desired)

Rush New 1955 Catalog.

Name _____
Address _____
City _____ Zone _____ State _____

RN-1-55

Send
for
your
copy
today

Home Study Courses in TELEVISION SERVICING offered by RCA INSTITUTES



Study Television Servicing—from the very source of the latest, up-to-the-minute TV and Color TV developments. Train under the direction of men who are experts in this field. Take advantage of this opportunity to place yourself on the road to success in television. RCA Institutes, Inc. (A Service of Radio Corporation of America), thoroughly trains you in the "why" as well as the "how" of servicing television receivers.

FIRST HOME STUDY COURSE IN COLOR TV SERVICING

Now you can train yourself to take advantage of the big future in Color TV. RCA Institutes Home Study Course covers all phases of Color TV Servicing. It is a practical down-to-earth course in basic color theory as well as how-to-do-it servicing techniques.

This color television course was planned and developed through the combined efforts of instructors of RCA Institutes, engineers of RCA Laboratories, and training specialists of RCA Service Company. You get the benefit of years of RCA research and development in color television.

Because of its highly specialized nature, this course is offered only to those already experienced in radio-television servicing. Color TV Servicing will open the door to the big opportunity you've always hoped for. Find out how easy it is to cash in on color TV. *Mail coupon today.*

SEND FOR FREE BOOKLET

Mail coupon in envelope or paste on postal card. Check course you are interested in. We will send you a booklet that gives you complete information. No salesman will call.



RCA INSTITUTES, INC.
A SERVICE OF RADIO CORPORATION of AMERICA
350 WEST FOURTH STREET, NEW YORK 14, N.Y.

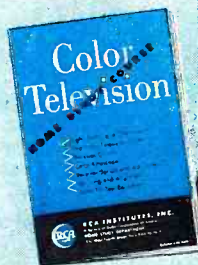

HOME STUDY COURSE IN BLACK-AND-WHITE TV SERVICING

Thousands of men in the radio-electronics industry have successfully trained themselves as qualified specialists for a good job or a business of their own—servicing television receivers. You can do this too.

This RCA Institutes TV Servicing course gives you up-to-the-minute training and information on the very latest developments in black-and-white television.

As you study at home, in your spare time, you progress rapidly. Hundreds of pictures and diagrams, easy-to-understand lessons help you to quickly become a qualified TV serviceman.

There are ample opportunities in TV, for radio servicemen who have expert training. Mail coupon today. Start on the road to success in TV Servicing.

MAIL COUPON NOW

RCA INSTITUTES, INC.
Home Study Dept. RN 1 55
350 West Fourth Street, New York 14, N. Y.

Without obligation on my part, please send me copy of booklet on:

- Home Study Course in TELEVISION SERVICING.
 Home Study Course in COLOR TV SERVICING.

Name _____ (please print)

Address _____

City _____ Zone _____ State _____

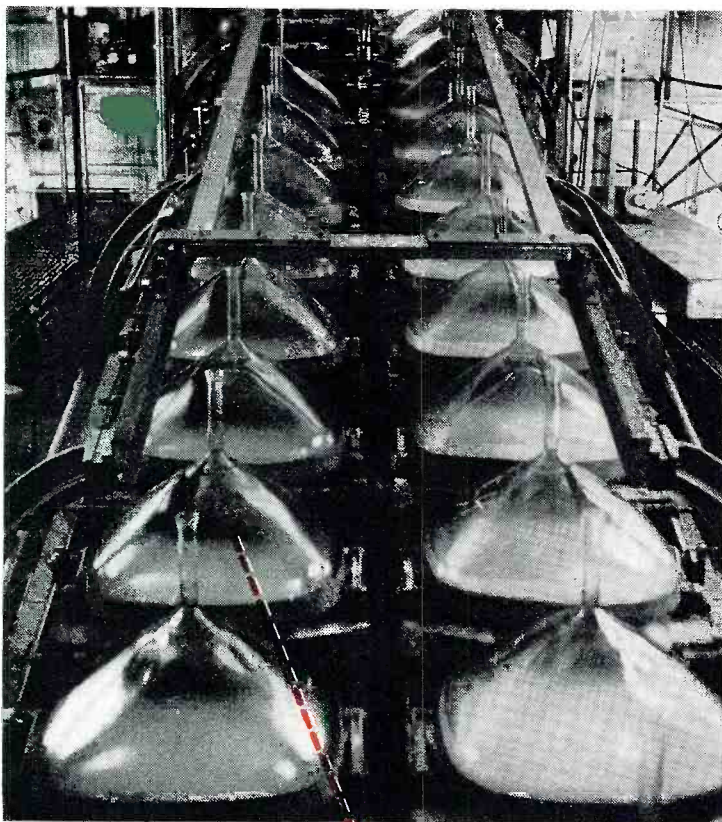

From ZERO to CAPACITY PRODUCTION IN THREE MONTH !

The same "advanced-engineering" that produced the CBS-Colortron and the Mirror-Back picture tube also engineered and built this modern CBS-Hytron plant at Kalamazoo, Michigan. The same drive typical of CBS-Hytron activity brought this complex industrial operation up to capacity production just three short months after first shipments began. For the ability to keep pace with your demands . . . for premium quality in TV picture tubes, look to the fastest-growing, most modern and forward-thinking company in the industry — CBS-Hytron.



CBS-HYTRON

Main Office: Danvers, Massachusetts

A Division of Columbia Broadcasting System, Inc.

A member of the CBS family: CBS Radio • CBS Television • Columbia Records • CBS Laboratories • CBS-Columbia • CBS International • and CBS-Hytron

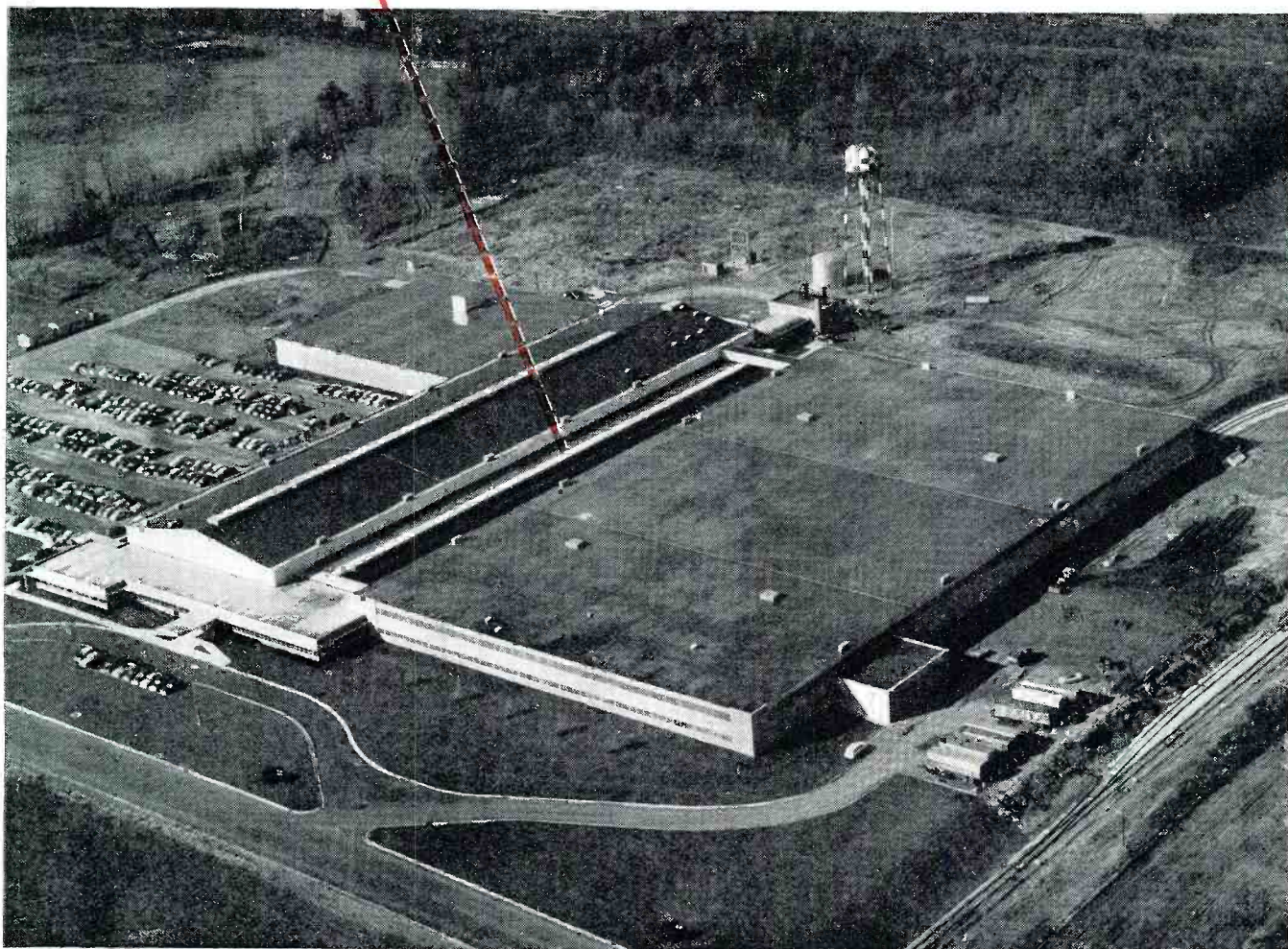

SPECIAL TELEVISION REPORT

TV chassis of the future...

WALSCO PC-9 COMBINES FIRST COMPLETELY PRINTED CIRCUIT CHASSIS WITH AUTOMATIC OPERATION

The introduction of the first—and only—entirely “printed circuit” television chassis marks a dramatic departure from all present day receivers. The super-sensitive Walsco PC-9 automatically produces the exact, crystal-clear performance found only in precision TV control room monitors.

The new custom PC-9 chassis offers keyed automatic gain control, automatic brightness and contrast, automatic elimination of vertical retrace, magnetic centering, direct current restoration, inverse audio feedback for greater sound fidelity, two video amplification stages, advanced cascode turret tuner, plus twelve other future features.

Either 21, 24, or 27 inch tube (90° deflection) can be used without modifying the chassis. The PC-9 is available now at user's net of \$299, including remote control with 20 feet of cable and tube mounting kits.

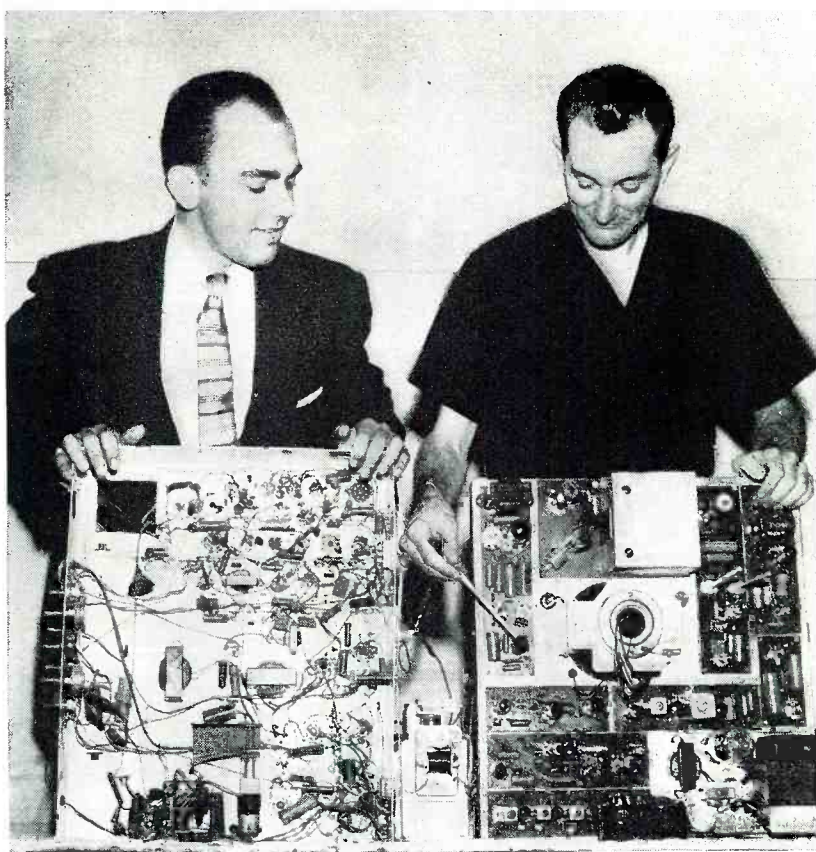

No more “jungle” of wires. Chief Engineer Fred Miller (right) makes a side-by-side comparison of a Walsco PC-9 (right) with a conventional, complicated chassis. Bob Mueller, Walsco Sales Manager, observes simplicity of vertically mounted, printed circuit design.

Printed circuits prevent faulty connections and production errors. Special machines and dip-soldering reduce the usual 2900 hand soldered connections to only 56 in the new PC-9 chassis. This advance circuitry provides ultra-clear reception on all channels. Each circuit strip plugs into PC-9, making servicing simple and quick.

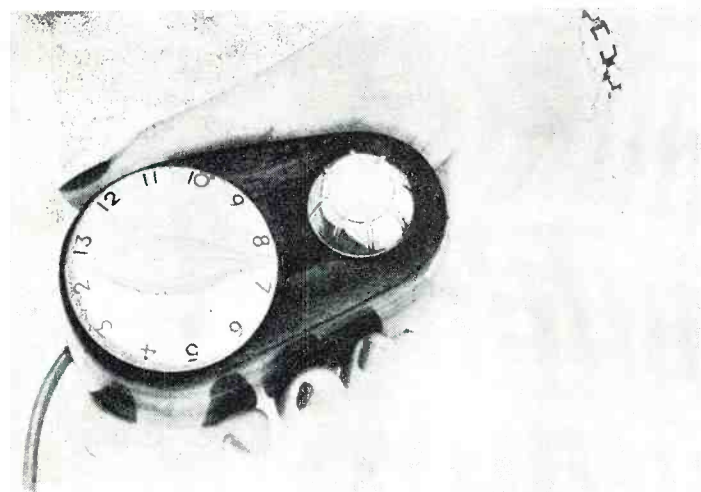

Completely portable, hand-size remote control. Exclusive “open circuit” control automatically finds the channel...instantly locks in perfect picture and sound. Since all fine video adjusting is automatic, this remarkable, motor driven unit has only the volume (on-off) knob and the channel dial.

For information write to Walsco Electronics Corporation, Dept. N-15-3602 Crenshaw Blvd., Los Angeles 16, Calif.

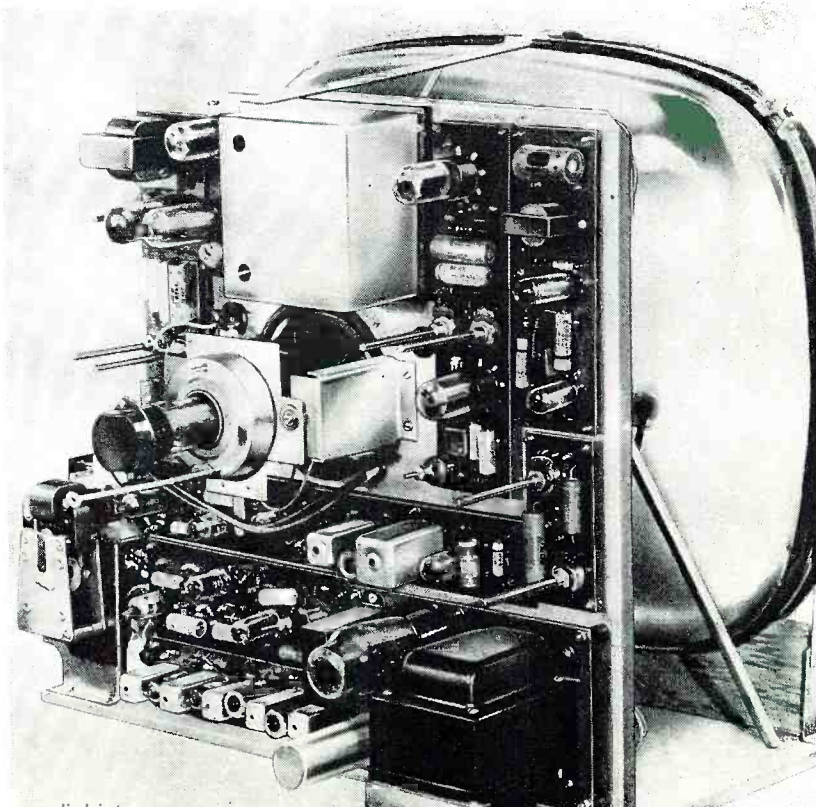

Centralab Type MD Molded Disc

**New,
completely insulated
ceramic
disc capacitor**



**Nine ways better
than an
ordinary disc**

Highest Leakage Resistance

Initial, 10,000 megohms. After 100-hour, 95%-humidity test, 1000 megohms. Returns to initial rating upon drying. Insulation resistance of molding, 300,000 megohms. This guarantees longer life, safer operation.

Highest Dependability

Wholly produced in Centralab's own plants, under strict control of ceramic, as well as capacitor, engineers. Centralab makes only ceramic capacitors—thus is interested first, last, and always in ceramic capacitors.

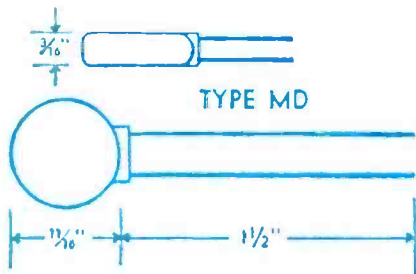

Highest Moisture Resistance

The capacitor body itself has moisture absorption of only .007% or less. The molded casing has moisture absorption of .005% or less. This is less than the china dishes you use for food.

The only ceramic disc of its kind—there's nothing else like it! It took four years to build—and an investment of over \$100,000.00 in production equipment.

No matter how you look at it, the Centralab Type MD Disc gives you more for *your* money—gives *your customer* more for his.

No, sir, when it comes to high quality and high standards of performance, you just simply cannot beat Centralab MD's. See for yourself — try them as replacements on your next few jobs.

Easy Identification

Clearly labeled to avoid confusion and mistakes. Coded in accordance with JAN specifications. Each unit labeled with capacity and voltage rating.

Highest Mechanical Strength

Will not chip, crack, or break under rough handling or dropping. One-piece construction is unaffected by extremes of vibration.

Molded Insulation

Completely insulated with Centrathene. 2500 V.D.C. breakdown to ground. You can place an MD next to a chassis or high-voltage leads without flashover or breakdown through the case. Fungus proof. Unaffected by ozone, salt water, or any known acid or solvent at room temperature. Will not become brittle at -55°C .

Highest Lead Strength

You'll need a pair of pliers and a vise to strip these leads. MD's have the highest lead strength of any ceramic disc on the market—greater than the breaking strength of the wire itself.

Complete Range of Values

52 values from 5 mmf. to .01 mfd. Voltage rating, 1,000 V.D.C.W. to 4000 mmf.; 600 V.D.C.W. over 4,000 mmf. Tolerance, $\pm 10\%$, 5 mmf. through 680 mmf.; $\pm 20\%$, 750 mmf. through .005 mfd. GMV (guaranteed minimum value), .0056 mfd. through .01 mfd.

Conservatively Rated

100% flash-tested at double-rated voltage. Periodically spot-checked at 1000-hour load life at test voltage.

Package of 5 only **\$1.50**

Suggested list price

Send coupon for Centralab Catalog No. 29, for further facts on MD's and other products.

Centralab

A Division of Globe-Union Inc.
910AE, Keefe Avenue, Milwaukee 1, Wisconsin

Send me Centralab Catalog No. 29

Name _____
Company _____
Address _____
City _____ Zone _____ State _____

FREE 1955 EICO CATALOG!

Tells you how to SAVE 50% on
your test equipment costs!

EICO

THE LARGEST MANUFACTURER OF ITS KIND IN THE WORLD

KITS INSTRUMENTS

THE INDUSTRY'S MOST COMPLETE LINE OF KITS & INSTRUMENTS
1/3 MILLION EICO INSTRUMENTS IN USE THE WORLD OVER —
SAVE 50% — BUILD 'EM IN ONE EVENING... THEY LAST A LIFETIME

the Exclusive **EICO** Make-Good
GUARANTEE

Each EICO Kit and Instrument is doubly guaranteed by EICO and your dealer in constantly selected quality components. EICO guarantees to replace any component which might become defective in normal use if returned to the factory within 90 days of purchase. EICO guarantees all Kits assembled according to EICO's simplified instruction will operate as specified therein. EICO guarantees service and calibration of every EICO Kit and Instrument at the nominal charge as stated in the instructions.

ELECTRONIC INSTRUMENT CO., INC.
Test Equipment Manufacturers
84 WITHERS STREET, BROOKLYN 11, N. Y.



NEW! #232 PEAK-to-PEAK
VTVM with DUAL-PURPOSE
AC/DC UNI-PROBE (pat. pend.)
KIT \$29.95 WIRED \$49.95

NEW! #249 DELUXE
PEAK-to-PEAK VTVM with 7 1/2"
METER & UNI-PROBE (pat. pend.)
KIT \$39.95 WIRED \$59.95



VACUUM TUBE VOLTMETER #221
KIT \$25.95 WIRED \$39.95

DELUXE VTVM (with 7 1/2"
METER) #214
KIT \$34.95 WIRED \$54.95



R-C BRIDGE & R-C-L
COMPARATOR #950B
KIT \$19.95 WIRED \$29.95



MULTI-SIGNAL
TRACER #145
KIT \$19.95
WIRED \$28.95



DELUXE RF SIGNAL
GENERATOR #315
KIT \$39.95 WIRED \$59.95



6V & 12V BATTERY
ELIMINATOR & CHARGER
#1050
KIT \$29.95 WIRED \$38.95



NEW! #944 FLYBACK
TRANSFORMER & CHOKE
TESTER
KIT \$23.95
WIRED \$34.95



RF SIGNAL GENERATOR #320
KIT \$19.95 WIRED \$29.95



TV/FM SWEEP GENERATOR #360
KIT \$34.95 WIRED \$49.95

A PROBE FOR EVERY PURPOSE

5MC—4.5MC CRYSTAL
\$3.95 ea.

EICO

See the famous EICO line at your jobber today
SEND FOR FREE CATALOG R-1
ELECTRONIC INSTRUMENT CO., Inc.
84 Withers Street • Brooklyn 11, N. Y.
Prices 5% higher on West Coast

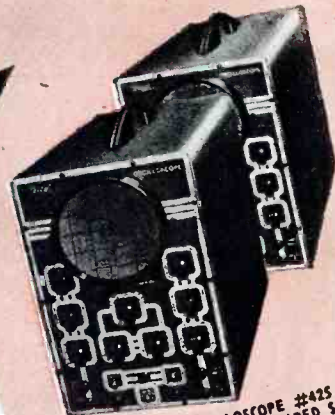

5" PUSH-PULL OSCILLOSCOPE #425
KIT \$44.95 WIRED \$79.95

NEW! #470 7" PUSH-PULL OSCILLOSCOPE
KIT \$79.95 WIRED \$129.50



CRA . . . \$4.50

TUBE TESTER #625
KIT \$34.95 WIRED \$49.95



20,000 Ohms/Volt
MULTIMETER #565
KIT \$24.95
WIRED \$29.95



1,000 Ohms/Volt
MULTIMETER #536
KIT \$12.90
WIRED \$14.90

Over-all view of the transmitter and its separate power supply. Switches have been labeled for easy identification. Note the small metal straps fitted to underside of transmitter to permit desk-top operation. Input and output power supply connectors are shown on the chassis of transmitter.

By MAURICE P. JOHNSON, W3TRR
and
ROBERT L. HANKEY, W3OBC
WAAM (TV) Engineering Dept.

SIX-METER EMERGENCY TRANSMITTER

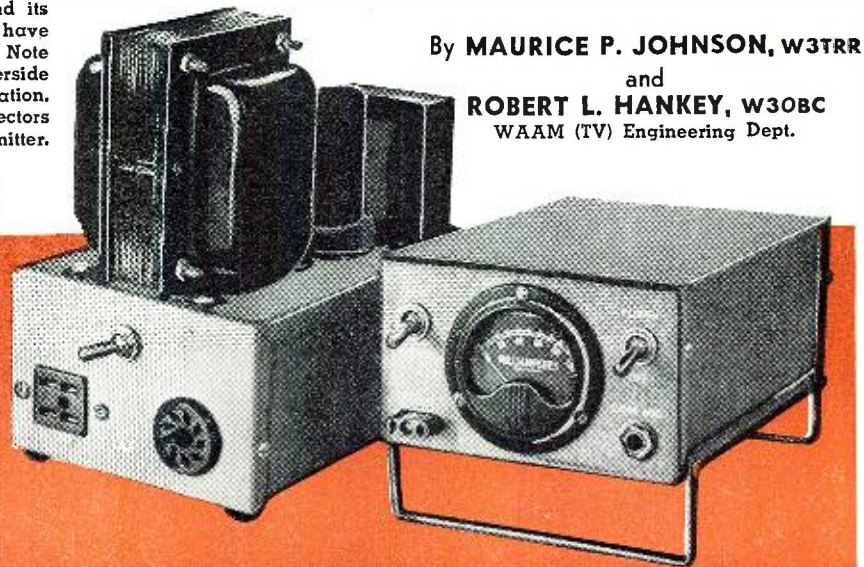

AND POWER SUPPLY

Designed to operate on either a 6-volt storage battery or on regular 117-volt a.c. power sources, this unit is intended for emergency or CD amateur radio communications.

NEARLY everyone is aware that amateur circles are focusing increased attention upon equipment suitable for emergency type communication. This is very evident in the current activity of RACES and CD organizations. In keeping with this interest, a project was initiated some time ago to design ham radio gear that would be applicable to such emergency uses. Study of the situations encountered in such communication work disclosed that equipment of three general classes would be worthy of consideration: namely, low-power hand carried transceivers, mobile-portable rigs, and fixed or base station rigs. A reliable battery-powered transceiver, designed as part of this project, was described in the August, 1953 issue of *RADIO & TELEVISION NEWS*. This article will be concerned with a mobile-portable transmitter and its dual purpose power supply, one of the pieces of gear that has been designed to fill the needs of the second listed class.

As previously discussed, in the article covering the transceiver, this entire project is based upon six-meter, single-frequency, network-type operation. In particular, the mobile-portable equipment is intended to coordinate and increase the service area of the transceivers, by functioning as readily movable area control stations. With their somewhat higher power, the mobile-portable rigs serve to relay messages to other similar units, or on to base stations. This equipment therefore must be compact, sturdy, and easy to adjust and operate.

Design Considerations

Because this equipment is intended for mobile-portable usage, compactness and efficiency become significant factors of the design. However, in such service, it is no longer necessary to limit the power requirements to the very low levels of the hand-carried

transceivers. To function equally well in either mobile or portable operation, it was decided that it should be possible to utilize 6-volt auto battery and 117-volt a.c. power sources. Naturally, a single power supply capable of running with either power source is to be desired. In the interests of keeping battery drain at a reasonable level, a supply providing 300 volts output at 100 ma. was considered to be adequate. The transmitter was then designed to utilize this input power effectively.

A power supply to furnish this voltage and current, and also able to operate on either of the specified power sources was found practical. Fortunately, a commercially-available power transformer featuring dual primaries with proper secondary ratings is avail-

able, thereby happily circumventing the necessity of having to "home brew" this essential component.

The decision to assemble the power pack on a separate chassis was made for several reasons. This same supply is capable of powering other pieces of gear in this project; therefore, the interchangeability of supplies is advantageous. Secondly, the separate supply can be located away from the transmitter, which is desirable in mobile work. (Also, for any entirely mobile uses, a regular vibrator pack can be used for power). Obviously, a separate power supply permits the transmitter proper to be more compactly built, besides helping to isolate hum and vibrator hash and noise.

Operational controls or switches on

Rear view of transmitter and power pack with the covers removed to show parts layout and wiring. Note tube mounting deck in transmitter and rear connectors.

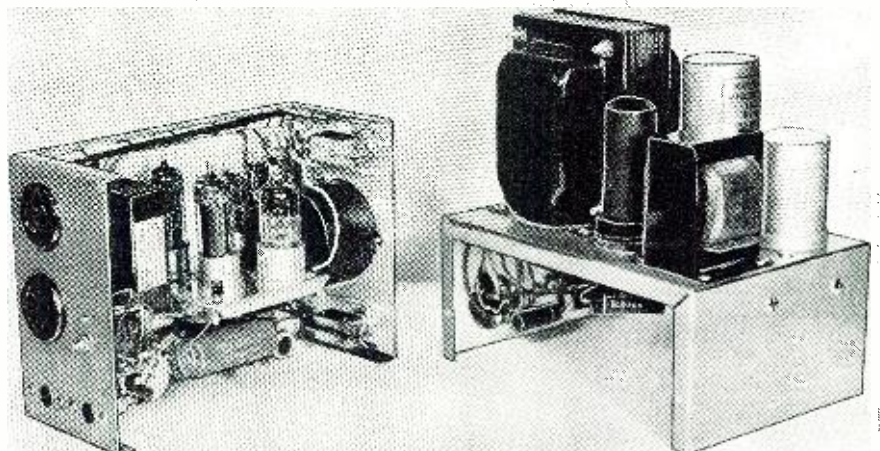

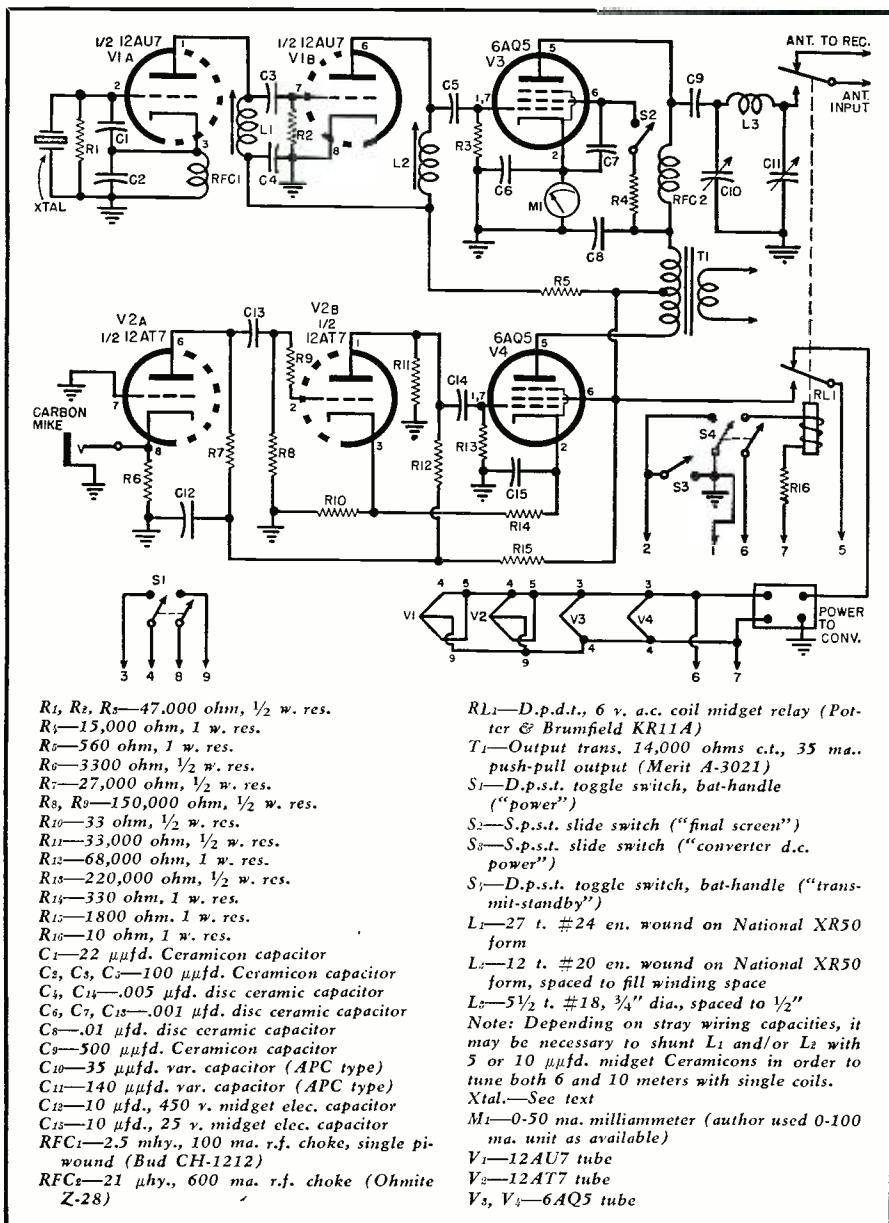

Complete schematic diagram of the 6-meter emergency transmitter for CD use.

the supply chassis are to be avoided, particularly when, as stated, the supply may be located remote from the transmitter. Consequently, provision is made for all operating control to take place at the transmitter.

Before proceeding to the transmitter itself, some features of the dual input power supply should be pointed out. Power is introduced to the pack through the use of a four-prong plug of the Jones 400 series. Two primary power cables are used, one for 117-volt a.c. operation, the other for 6 volts d.c. Two prongs of the socket are wired to the a.c. primary, the other two are used for the d.c. input. Since the socket is polarized, no danger of wrong insertion exists. To avoid excessive voltage drop, the d.c. plug is wired with husky battery cable fitted with heavy duty clips for connection to the battery. These leads are color coded, as one side of the d.c. circuit is grounded to the power pack chassis.

Connection is made to the transmit-

ter with an eight-wire shielded rubber-covered cable fitted with 9-pin plugs at either end. The majority of the cable leads are used for the control circuits, yet to be described. The high voltage side of the supply is conventional. A tube with an indirectly heated cathode is used as a rectifier purposely to prevent the supply from delivering voltage until the transmitter tubes are hot and drawing current. This avoids voltage surges in the supply.

In addition to the pi-section filter for removing ripple, an L section is added to remove vibrator noise. A protective resistor connects in series with the buffer capacitor across the secondary.

Each of the primaries is separately fused. The battery circuit features a heavy duty non-synchronous vibrator to pulse the d.c. input. This circuit includes a hash filter. An inexpensive auto headlight relay is used in the d.c. control circuit.

The filament supply circuitry incorporates a double-pole, double-throw switch in the power supply. While running with a d.c. source, this switch connects the heaters to the battery. With an a.c. input, a part of the vibrator winding is used to provide 6.3 volts a.c. for the tubes. This toggle switch is located between the power plugs as a reminder to select the proper position whenever the input source cable is changed.

To reduce hash radiation, a metal-shelled 6X5 and shielded interconnecting cable are used. The "Minibox" chassis forms a complete shield. Grounding the vibrator shell and connecting the supply chassis to the car ground also make a marked improvement.

Some thought was given to the tube lineup for the transmitter. Several possibilities presented themselves, since there are available tubes especially intended for low-power r.f. uses. However, ease of procurement is of paramount importance in emergency application, so it was decided to make use of receiving tubes of the miniature types. The final stage operates in the ten-to-fifteen watt range, so the ever-popular 6AQ5 was selected for this r.f. use.

To insure proper loading into a variety of antennas such as might be encountered in emergency work, a pi-network is incorporated as the tank circuit of the 6AQ5. A frequency-rated choke gives better results than an ordinary pi-wound universal choke used for the parallel plate feed. A single two-inch round milliammeter in the final cathode is the only metering needed. Opening the screen lead with switch S_2 allows the meter to indicate grid drive, while closing the switch enables the meter to be used for output tank adjustment, as well as monitoring the final in routine operation. A 0-100 ma. meter happened to be used in the rig pictured, but a 0-50 ma. range is suggested as more in keeping with the currents encountered in this transmitter.

The final stage produces output on the 50 mc. band, a high frequency in terms of the 6AQ5, so it was decided to use the final as a doubler to avoid the intricacies of neutralizing the tube as a straight-through stage.

A single 12AU7 forms the exciter portion of the transmitter. This circuit in various forms has achieved considerable favor in mobile work as a simple and neat way to obtain sufficient drive for a 6AQ5. Slug-tuned coils are used in broadband tanks for each plate. Crystals in the 6 mc. range are used, with L_1 tuned to the second harmonic. The other half of the dual triode again doubles, with L_2 tuned to the fourth harmonic of the crystal frequency.

A high- μ 12AT7 is used for the speech amplifier. Cathode injection of the carbon mike provides for button current and side-steps the need for an input transformer. A couple extra resistors in the second stage give a

measure of speech clipping in an otherwise ordinary triode amplifier circuit. A 6AQ5 serves nicely as a class A modulator. Use of similar tubes for r.f. and modulator stages calls for a modulation transformer of one-to-one turns ratio. A neat trick is to use the primary side of a center-tapped output transformer, leaving the voice coil secondary winding unused. A suitable transformer, listed in the parts list, has high primary impedance and is compact enough to fit in the limited space available for it.

Control Circuits

Only two toggle switches appear on the front panel for use in regular operation, but the control wiring may seem a bit more complex than usual. This is the result of intergrating the switching needs of both a.c. and d.c. operation.

A brief run-through of the control circuits will serve to clarify the functions of the various switches and relays. The transmitter is turned on by the power switch, S_1 . One half of this double-pole toggle switch completes the 117-volt a.c. primary circuit. Thus, with S_1 on the power supply in the a.c. position, the tube heaters are turned on, and the power pack will then deliver voltage. However this voltage is being delivered through the normally-closed contacts of the changeover relay to a four-prong plug on the rear of the rig, and no plate voltage appears at the transmitter tubes until the transmit-standby switch, S_2 , is closed. The four-pin plug mentioned is to power a converter or receiver from the transmitter power supply, if so desired. This plug also carries heater voltage and "B—" return for this usage.

Closing S_2 completes the relay coil path, through leads 6 and 7, energizing the coil from the heater supply. This serves to apply the plate voltage to the transmitter, at the same time removing plate voltage from the plug feeding the converter or receiver, if used. It will be noted that this relay is a double-pole type, with the other pole acting as antenna changeover. Two antenna connections are provided on the rear of the rig. The normally-closed contactor loops over to the receiver, while the relay arm is connected to the antenna itself. Thus a common antenna is used for transmit and receive.

The control action is similar when operating from storage battery sources. The second half of S_1 completes the d.c. filament path, but the high voltage section of the power supply is inoperative until switch S_3 is closed. Cable leads 1 and 2 then serve to energize the headlight relay which starts the vibrator. This sequence cuts down battery drain by holding the vibrator supply off except for transmit sessions. In the event that a receiver is being used from the same supply, however, the switch S_3 can be closed to short across half of S_1 , thereby causing the supply to run continuously. Care must

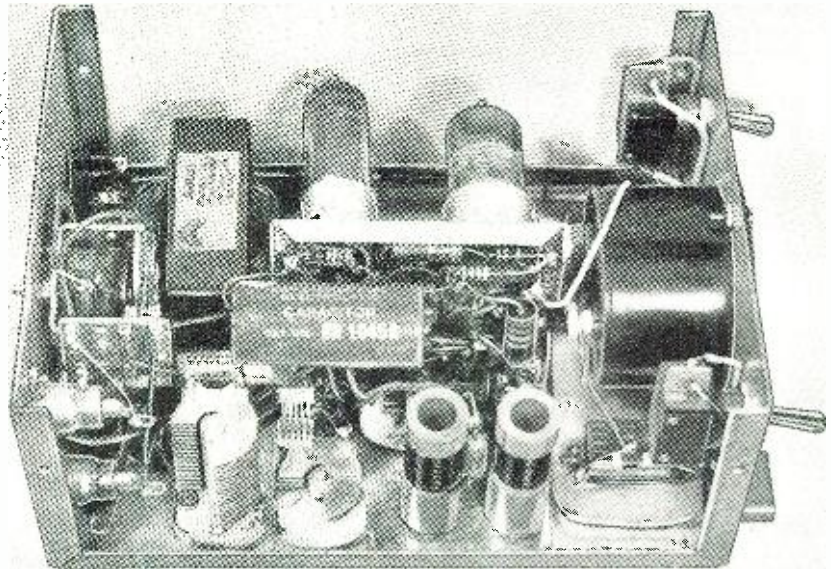

Completely wired transmitter unit with cover removed to show parts placement and wiring, as well as position of subassembly in the finished unit.

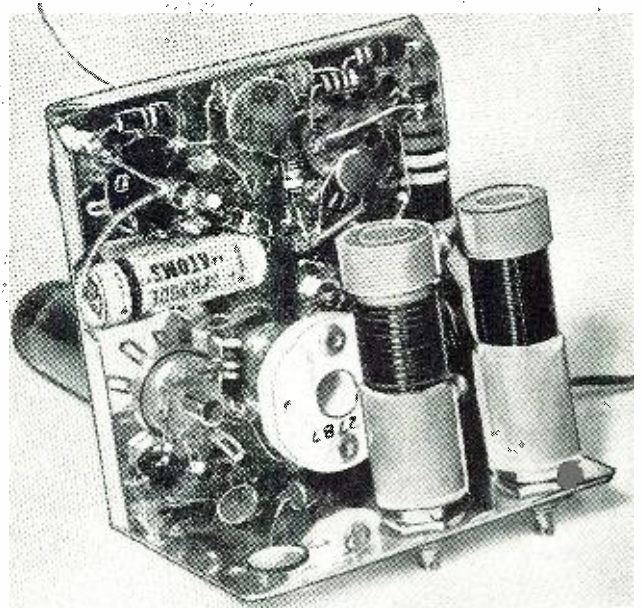

★
View of the subassembly ready to attach to main chassis. Direct wiring is used.

★
The transmitter wiring prior to mounting subassembly. Notice the cabled leads which connect front panel to rear lip, also subassembly mounting holes.

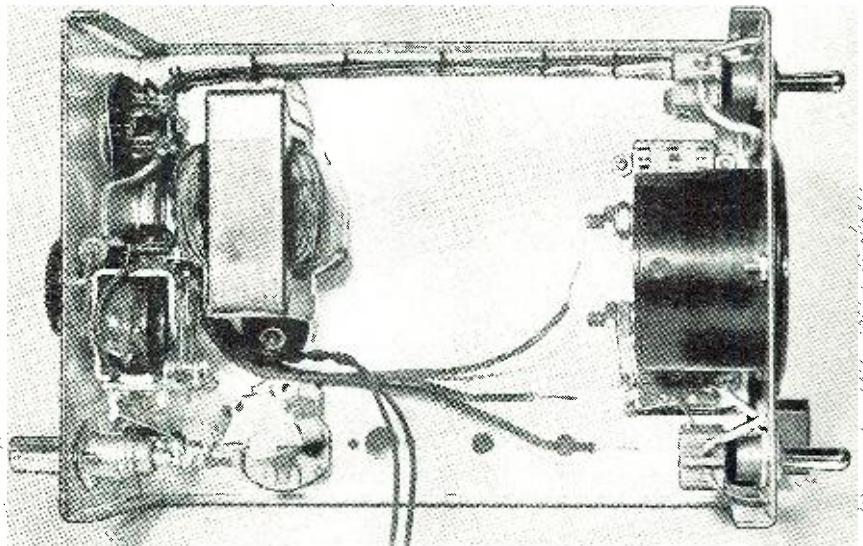

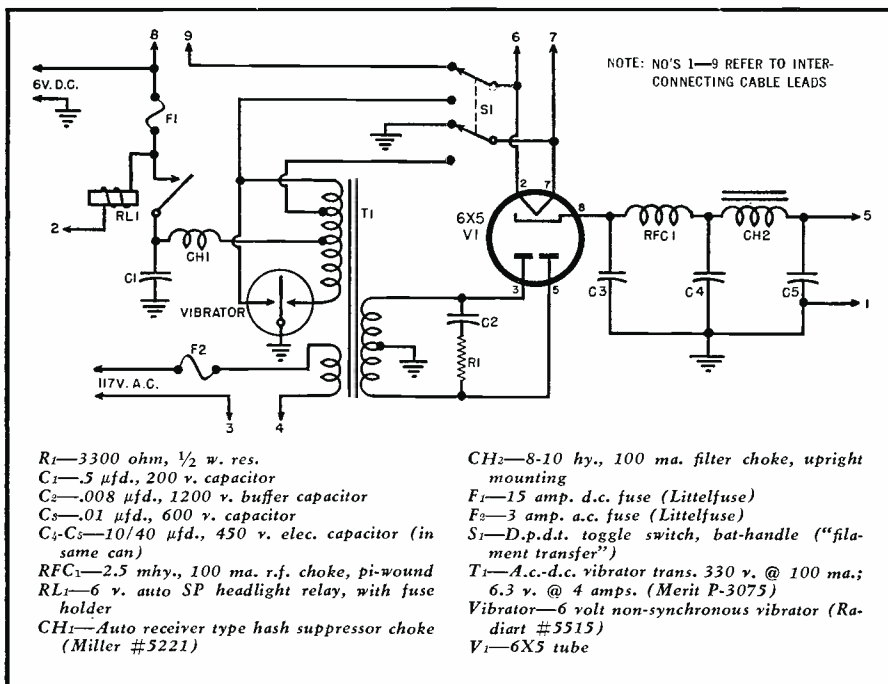

Dual-purpose power supply schematic. It is constructed on a separate chassis.

be exercised during such operation to remember to open *S₃* when the operating session is over, as *S₃* will be seen to bypass the power switch. This condition is the unfortunate result of considering it unwise to run the full d.c. primary current of about 10 amps through the power switch *S₁*. A pilot or neon light on the receiver will help serve as a reminder for such operating conditions, to insure shutting off the vibrator supply.

Examination of the accompanying photographs will do much to indicate the parts layout and construction style of the transmitter and its companion power pack. Each unit is assembled upon a Bud CU-2108 "Minibox," measuring 3 x 5 x 7 inches in size. A feature of these aluminum boxes is their two piece construction, each half forming three sides, such that the interlocked parts produce very complete shielding. The aluminum is easily worked, and the grey hammerloid finish makes a neat appearance.

Layout of the power supply is not critical, but it is suggested that all

parts be collected and arranged on the chassis before the holes are cut, to insure that sufficient space is allowed on the chassis top to mount those components. Remaining parts are fastened to the underside and two ends of this "Minibox" half. The power input and output connectors and filament transfer switch are secured to the rear, while the headlight relay fastens to the opposite end. Heavy wire should be used for all d.c. primary wiring to prevent voltage drop, because this circuit carries approximately 10 amps when running from a storage battery.

The transmitter is completely housed within its "Minibox" chassis, including relay, tubes, and transformer. Thus the unit is quite compact and the possible damage to protuberances is prevented. The transmitter is constructed as two parts which are then fastened together and interconnected. This technique helps simplify the assembly of what could otherwise become a congested affair.

As in the power pack, the components again are mounted to half of

the "Minibox," so the other part becomes an easily removed top shield cover, which incidentally, permits an easy attachment to the underside of the auto dash in mobile work.

The meter mounts centrally on the front, the power switch and the mike jack to the right, with the transmit-standby switch and the crystal socket on the left to complete the control panel. Accessible at the back are the power and antenna connections. The changeover relay fastens inside the rear lip, adjacent to the antenna connector. The modulation transformer and pi-tank capacitor (output) occupy space directly next to the rear lip, such that only 2 1/4 inches of the bottom are filled. Slide switches *S₃* and *S₂* locate on the bottom, at either side of the meter. This leaves a clear center section to accommodate the subassembly.

The four tubes and associated parts make up this subassembly, constructed on an aluminum bracket. The speech amplifier and modulator tubes are at the top, the r.f. and exciter tubes below, with *RFC₁* between the r.f. sockets. The bottom bracket lip extends to permit mounting the coils *L₁* and *L₂*, and input pi-tank capacitor. These parts are used to tie the subassembly to the main chassis. Point-to-point wiring and short leads help keep the hookup simple and stable mechanically.

Ten-Meter Operation

In examining the r.f. lineup, the possibility of ten-meter operation arose, and was found to be very easily accomplished. A crystal in the 7 mc. range should be used. Coil *L₁* can be adjusted to cover 14 mc. by unscrewing the coil slug. Likewise, *L₂* will hit 28 mc. with its slug backed out. The final must then run straight-through, but by care in parts placement, it is quite stable under load at this somewhat lower frequency. It may be necessary to juggle the value of *L₃* a bit to make the final load into certain antennas on ten, but otherwise the rig will cover the band nicely without changing its six-meter constants. By tuning the coils near the center of the band, frequencies can be shifted in either direction without any retuning, which makes the rig an asset for mobile or low power QSO'ing on ten.

Tuning adjustments are accessible from the bottom, and tuning up is simply a matter of peaking the two coils and then loading the final into the antenna. The auto broadcast whip loads nicely on six. The final r.f. cathode should be loaded to approximately 40 ma., and the grid drive will read 2 or 3 ma. with normally active crystals.

A carbon mike is used, and the audio gain is sufficient for good modulation with close-talking mike technique. With a converter or receiver running on the common supply, send-receive changeover is done with one switch, *S₁*. The rig is rugged and a pleasure to use.

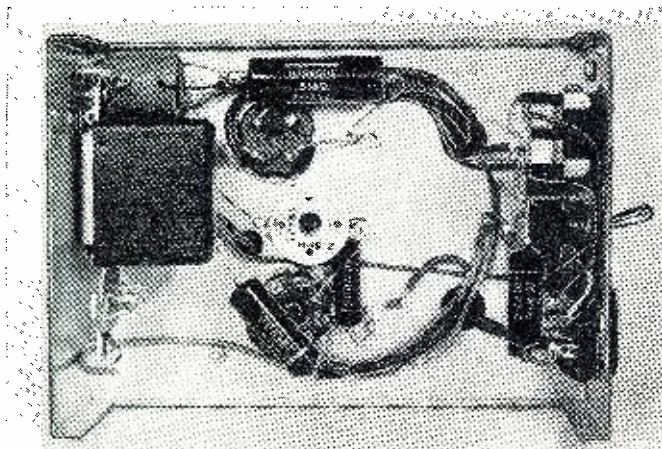

Under chassis view of the dual-purpose power supply showing parts placement.

A CASCODE TELEVISION BOOSTER

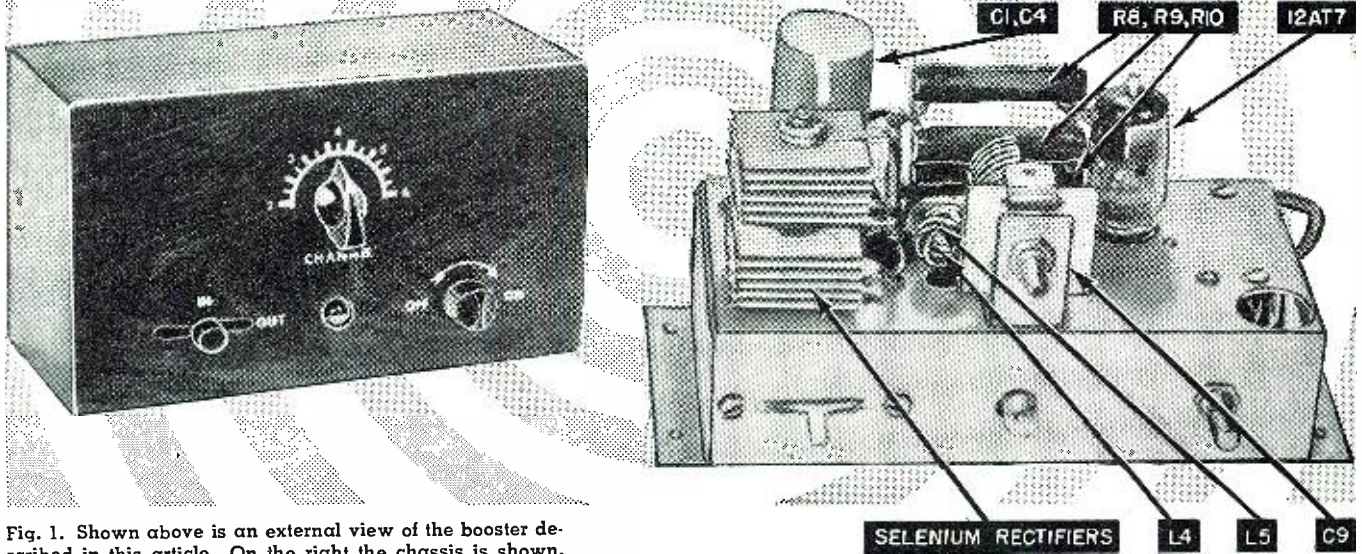

Fig. 1. Shown above is an external view of the booster described in this article. On the right the chassis is shown.

In the very recent past, scientists and engineers made the statement that radio waves on the order of frequencies found in the television and frequency-modulation bands would not be received very well beyond the line of sight or approximately fifty miles. But of course, in this day and age there are a vast number of unbelievers who will try anything and they went ahead and obtained good television reception anyway, considerably beyond what was originally thought to be the limit. TV reception from stations as far as 150 to 200 miles under good conditions and with proper equipment is not too unusual. However, most times, the receiving equipment includes an effective booster.

To be described here (and shown in Fig. 1) is a good TV booster that is not difficult nor costly to make. It uses a cascode circuit. A pentode tube is hard to beat for gain, but is well known for its inherent internal noise. The conventional triode circuits are low in noise content but are usually unstable without neutralization and do not have the gain of a pentode. The cascode circuit has high gain with low internal noise and maximum stability because of the characteristic low impedance of the circuit that is obtained with the cathode coupling. Bandwidth is very broad and thus, the booster does not sacrifice the audio for picture gain.

The described circuit was used in conjunction with several other popular brand boosters and a switching circuit so that the set and antenna could be quickly changed from one booster to another for several different types of signal and a comparison made. It compared very favorably to the commercial units.

The over-all schematic in Fig. 2 shows all the necessary data for building the booster, and Figs. 1 and 3 show the placement of parts. There is an

By **HARDIN G. STRATMAN**

Build this low-noise v.h.f. booster using a cascode circuit. It is inexpensive and simple to construct.

alternate method of connection that can be noted on the circuit diagram. This entails using a jumper in place of L_2 and eliminating L_1 and C_3 completely. The addition of L_2 and L_1 plus C_3 increases the gain but tends to cut

down the bandwidth slightly and oscillations may occur if the peaking is too sharp. The builder can try both methods and choose the one he desires as the change involves only a few seconds. (Continued on page 116)

Fig. 2. Schematic diagram and parts list for the cascode booster. The dotted lines indicate an alternate circuit that may be used. The booster is in use with switch S_2 as set; in its other position the antenna feeds the set directly.

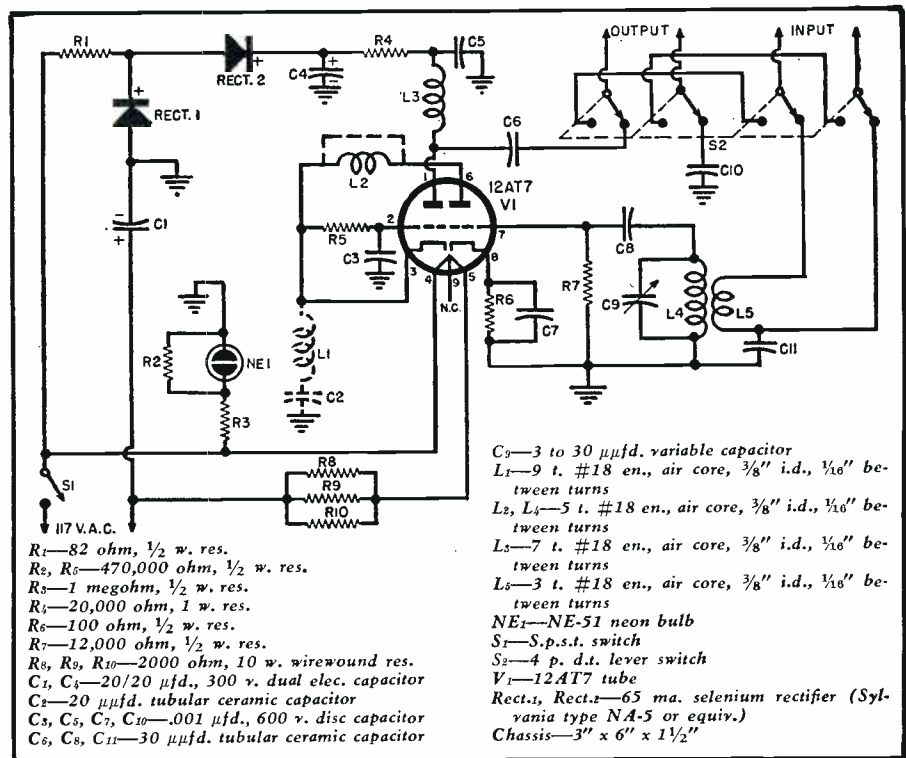

BUILD YOUR OWN COLOR TV CONVERTER

By
JAY STANLEY

Adjusting the color converter does not require any special test equipment other than the standard TV test instruments, including a v.t.v.m. as shown.

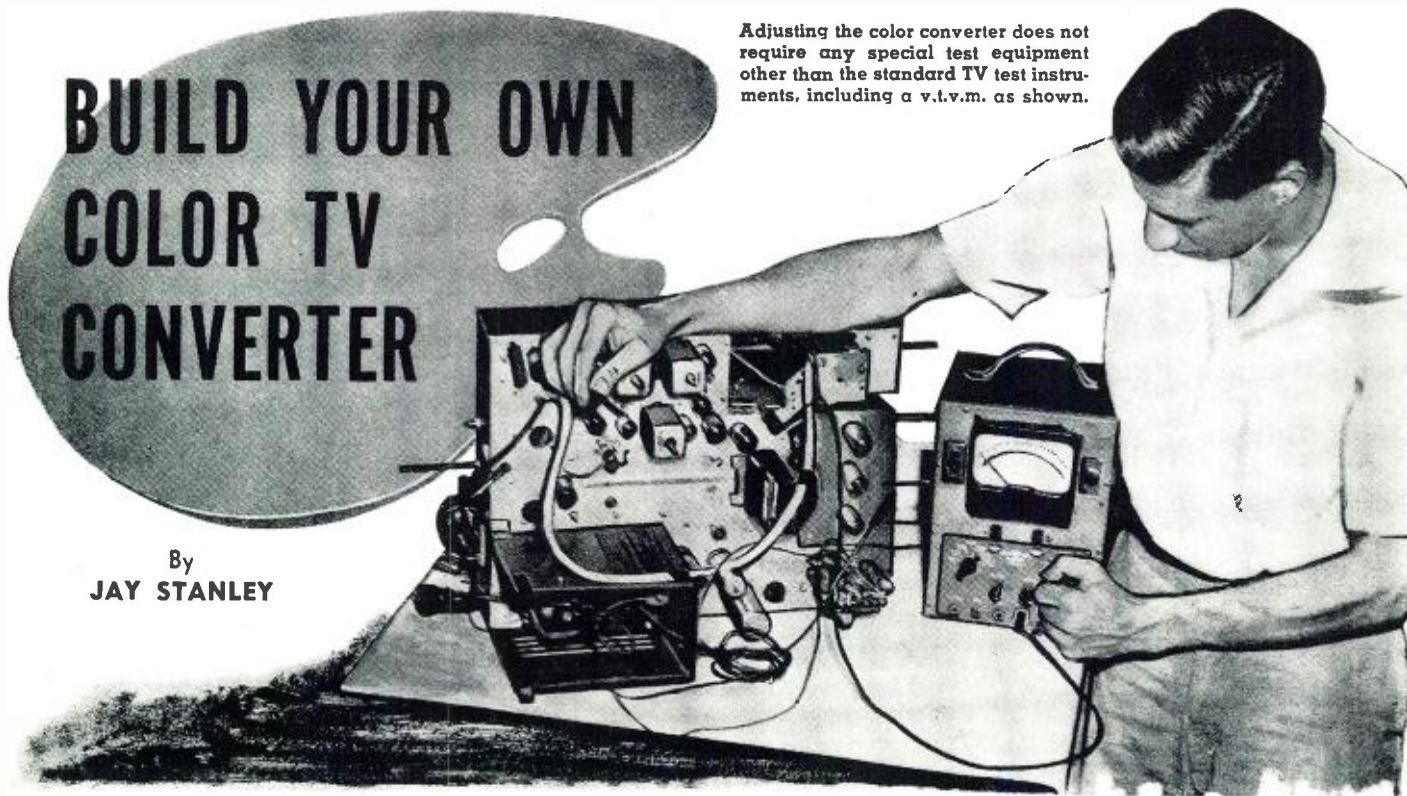

Part 2. Complete step-by-step tune up instructions for the TV color converter described last month, including hints for using a 3-gun tube instead of projectors.

THIS article covers a step-by-step procedure which will enable you to get the color converter described in the December issue of *RADIO & TELEVISION NEWS* going. Essentially, it is a procedure which will get adjustments so close to the ideal that final, minor adjustments can be made with a color broadcast tuned in.

First, equipment. You'll need a good signal generator, one capable of tuning the 3.58 megacycle range with very little drift after the initial warmup. Also needed are a v.t.v.m. fitted with an r.f. probe, a standard service-type scope, and a sweep generator which will sweep from 1 megacycle to 5 megacycles.

To begin with, align the black-and-white TV chassis as close as possible to the ideal i.f. curve shown in Fig. 1A. Be certain to avoid sharp corners on the i.f. response curve (Fig. 1B) which can introduce highly undesirable phase shift.

Next, make certain that the set receives black-and-white pictures through the color tubes. This will enable you to determine that the Y channel is working, and will allow you to get brightness, focus, and convergence of the three projection tubes in proper adjustment. Unless the brightness controls, for example, are at something like the proper level, color alignment is virtually impossible.

Now, we're ready to start.

Connect the signal generator (with a 10- μ fd. capacitor in series with the

"hot" lead) to the first video amplifier grid in the black-and-white set. Tune in a black-and-white picture, and make certain that the picture is in proper horizontal sync. Then, pull out an i.f. tube to keep any stray signals from reaching the video detector. Set the signal generator as close to 3.58 megacycles as possible, preferably with crystal calibration. When you get it reasonably close to the proper frequency, you should see some indication of color on the raster—in the form of random streaks and shapes.

Now, pull out the 6U8 oscillator and reactance tube on the color converter chassis, and connect the v.t.v.m. with the r.f. probe to pin 5 of the color burst amplifier, V_2 , 6CB6, and tune the burst take-off coil, L_3 , for maximum. Remove the probe. (Note: All parts numbers refer to Fig. 3 in the December article.)

Next, ground pins 1 and 2 of the 6AL5 phase detector, V_1 . Set the v.t.v.m. on the d.c. voltage scale (50-volt scale or higher), connect it to pin 5 of the 6AL5, and tune T_1 , the phase discriminator transformer (both slugs), for maximum d.c. voltage. When this is done, remove the ground from the 6AL5 pins 1 and 2.

Replace the 6U8 reactance tube, pull out the burst amplifier, V_2 , and connect the voltmeter with probe to pin 7 of the B-Y demodulator (V_3 , 6AS6). Tune both slugs of the crystal output transformer, T_2 , for maximum reading. You will notice that as you tune the

primary of this coil (turning the slug clockwise) you will start toward a maximum reading, and then the oscillator will overload and stop oscillating. Back the slug out a few turns from this point, and the oscillator will be stable. The secondary of the crystal output transformer will tune through a normal peak.

Now, connect the v.t.v.m. with probe to pin 7 of the R-Y demodulator (V_7 , 6AS6) and tune the output transformer of the 90-degree amplifier, T_4 , for maximum.

Replace the burst amplifier tube, and once again pull the 6U8 oscillator-reactance tube. Connect the sweep generator (sweeping from 1 mc. to 5 mc.) to the grid of the first video amplifier tube in the black-and-white TV chassis. Turn the chroma control, R_{ch} , to minimum, and connect the scope through a demodulator probe to the "hot" end of the chroma control. Tune the hand-pass amplifier (V_5) plate coils for the resonance curve shown in Fig. 1C. Markers should be provided by the signal generator, still connected to the grid of the video amplifier in the black-and-white set.

Disconnect the sweep generator, leaving the signal generator attached, and replace the 6U8 oscillator tube. At this point, it is a good idea to recheck for horizontal sync by tuning the black-and-white chassis to a TV broadcast.

For the next step, turn the chroma control full open and the signal generator to maximum output (unmodulated). Carefully tune the signal generator back and forth around 3.5 megacycles, and you will observe a pattern of color bars shifting around on the raster. You will notice that as

you approach the crystal oscillator frequency in the converter, this pattern will become a definite series of color bars, lying horizontally. As you get still closer to the exact frequency, you will note that the bars will become fewer and fewer, and finally disappear. The raster will assume an over-all tone of one color, which may even be simply an off-white. This indicates that the signal generator and the crystal oscillator in the set are *locked together*. (If you cannot achieve this effect, that fact is evidence that the color sync section is not working properly.) Carefully note the *exact* dial reading on the signal generator for future reference.

Now comes one of the most critical of all the tuning adjustments, so be very careful to do it exactly as described. *Slowly* tune the signal generator to a *lower* frequency than that of the crystal. "Slowly" cannot be emphasized too much, for there is real danger that you will pass right by the proper frequency. As you do this tuning, you will begin to see a series of color bars which move diagonally into a vertical pattern. If you tune slowly and carefully about this point, the signal generator will lock to the difference frequency between the crystal and the horizontal sweep frequencies.

Note carefully that as you tune below the crystal frequency there are quite a number of these "lock-in" points. Also, that the *lower* the frequency, the greater the number of bars. (The signal generator locks in at even multiples of the horizontal sweep frequency away from the crystal frequency.) Only the *first* lock-in point *below* the crystal frequency is the proper adjustment, and the only one which makes it possible to phase and align the color demodulators.

Keeping the signal generator locked to this point (as mentioned previously, the generator must be stable) the next step is to add the scope. Set the horizontal sweep in the scope to approximately twice horizontal frequency and switch it for external sync. The sync is obtained by clipping a lead to the "hot" deflection yoke wire (*over* the insulation—no direct connection).

Next, establish horizontal sync pulses by holding the lead to the input of the scope's vertical amplifier *close* (again, no connection) to the horizontal output plate lead in the black-and-white TV set chassis. Set the horizontal gain and horizontal centering of the scope to put these "pips" on two of the vertical calibrating marks on the scope face. See Fig. 1D.

Now, clip the input of the scope's vertical amplifier to the blue output. By carefully tuning the phase control, C_{16} , and the secondary slug of transformer T_2 , you will be able to position the sine wave as shown in Fig. 1E. Note that the positive peak of the sine wave should fall halfway between the two previously established horizontal sync points (180 degrees) shown in Fig. 1D.

Changing no settings, connect the

scope to the red output. Now tune the output of the 90-degree amplifier plate transformer, T_3 . *Important*, the positive peak of the red output must fall *exactly* where the blue went through the zero axis, as shown in Fig. 1F. This establishes the all-important 90-degree phase difference between the R-Y and B-Y signals.

Still changing no scope settings, connect the scope to the green output. Adjust the red, green, and blue add controls (R_{12} , R_{13} , and R_{11}) to position the sine wave so that its zero axis crosses through the point 29 degrees to the right of the point where the blue was maximum positive. (See Fig. 1G.)

Disconnect the scope, leaving the signal generator attached. On the screen you should have bands of color running vertically. You should be able to adjust the phase control to get a pattern which is orange on the far left, blending into red, then blue, and finally green. When you have reached this point, you are ready to try a color broadcast!

With the color signal tuned in, adjust the plate coil, L_1 , of the reactance tube to lock in the color signal. At this point, objects will become colored—even though bananas may look blue! Then adjust the phase control, and the color gain controls, for the most natural coloring in the picture. Once the color gain controls are set properly, correct coloring can be obtained by using the phase control only. This is the external color control available in some form on all color TV sets.

The chroma control affects the saturation of color, and is set to the taste of the individual viewer. One caution: if this control is set too high, the picture becomes garish and very grainy.

Just one more thing. The delay line may need some adjustment. This can be done by observing the color picture. If the color information seems to fall to the right-hand side of the black-and-white image, the delay line is too short. However, if you have made it 22" long,

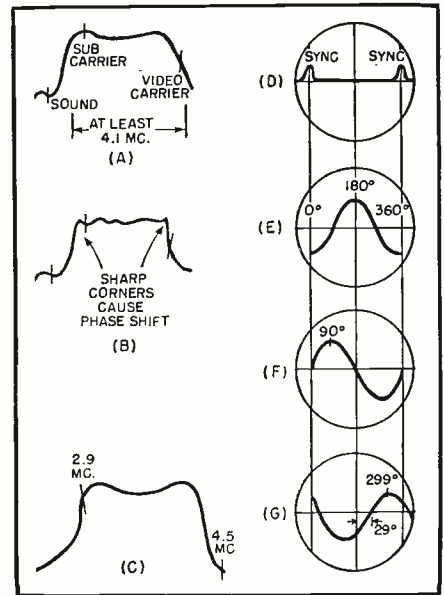

Fig. 1. Oscilloscope waveforms obtained during the various steps of the tune up procedure as described in the text. (B) is an incorrect waveform to be avoided.

the color will probably fall very slightly to the left of the black-and-white image. Trim the line a few turns at a time until the color picture and the black-and-white picture are perfectly superimposed.

3-Gun Tube

Either the 3-unit projection arrangement or a single projection unit with a color wheel provide the simplest way to get going with your color converter. However, if you desire to use a 3-gun tube, the RCA tri-color kinescope is available at some parts distributors, and here is the data you'll need.

First of all, because of the unequal phosphor sensitivity of the 3-gun tubes, it is necessary to make a slight change in the Y signal adding matrix to supply the unequal video drive required

(Continued on page 153)

★
Fig. 2. Additional circuitry that must be included in the converter when it is used with a three-gun color TV tube.
★

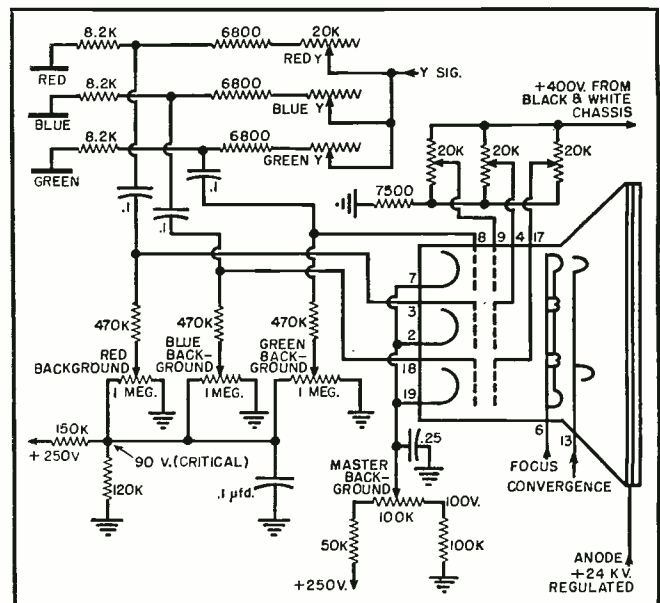

WHAT PRICE CROSSOVER ?

By **CHARLES E. DIEHL**
Registered Professional Engineer

Details on a home-made output transformer which is used in a crossover circuit which does not require added inductance.

THE crossover system to be described in this article was designed by the author and features high-fidelity output. The inductive portion of the system has been made a function of the output transformer. Transfer is the result of the transformer's tendency to maintain power level output.

The output circuit consists of two 4-ohm secondary windings with the end of one winding connected to the beginning of the second winding, forming a center tap for the network. One secondary has the tweeter's 4-ohm voice coil connected in series with a 32 μ f., 117 volt a.c. capacitor, C_1 (a Mallory motor-starting type, PS3210 at about two dollars). The woofer's

4-ohm voice coil is connected to the other secondary. Both voice coils have 15-ohm, 5-watt wirewound resistors in series with them. Normal operation is with both resistances cut out (zero resistance). These resistances, however, permit a setting that will distribute the highs and the lows as desired by the listener and also prevent the tweeter from blasting by cutting its power input.

Fig. 2 shows the crossover curves with the added bass boost obtained by feedback from the primary taps to the screens. This bass boost compensates somewhat for the natural fall-off curve of the human ear at low frequencies. This bass boost can be eliminated, if desired, by transferring the screens (terminal 4 in Fig. 1A) to the "B+" center tap or using an untapped primary transformer.

The system is designed around a pair of 6V6 tubes but is applicable to any other type tubes. Output is a clean 10 watts with 300 volts of "B+." The d.c. input to the two tubes is 60 ma. which is well below their 90 ma. rating. Distortion is less than 3 percent from 15 to 10,000 cycles of sine-wave input. All readings shown on the curve of Fig. 2 were taken at a con-

stant voltage level input, chosen to give a maximum 2 watt output at the bass peak.

The transformer is hand wound on a core with a 2-square-inch cross-section and a 1-square-inch window. The iron core weight is 3½ pounds and laminations are 14 mils thick. Less core weight will not register the lows and thicker laminations will not register the highs. The best core would have been one with laminations 7 mils thick but these are not easily obtained, at least to the author's knowledge.

The primary consists of 1500 turns of No. 32 *Formvar* wire each side of the center tap with the two screen taps at 300 turns each side of the center tap giving 6000 ohms impedance to the plate of each tube. The layout is as shown in Fig. 1B. The primaries are wound by winding two halves on a divided spool, each half being wound from the center tap outwards to make equal amounts and resistance of wire for equal tube load and to build output voltage rise equally both sides of center. To keep the two winding halves in the same direction, they must be wound in opposite directions. This will result in the same directional winding just as if the two halves were wound continuously and one over the other. This latter method may be used, if desired, although it does introduce some additional distortion

(Continued on page 159)

Fig. 1. (A) Circuit diagram of the author's crossover system. (B) Details for winding the transformer used in system. See text.

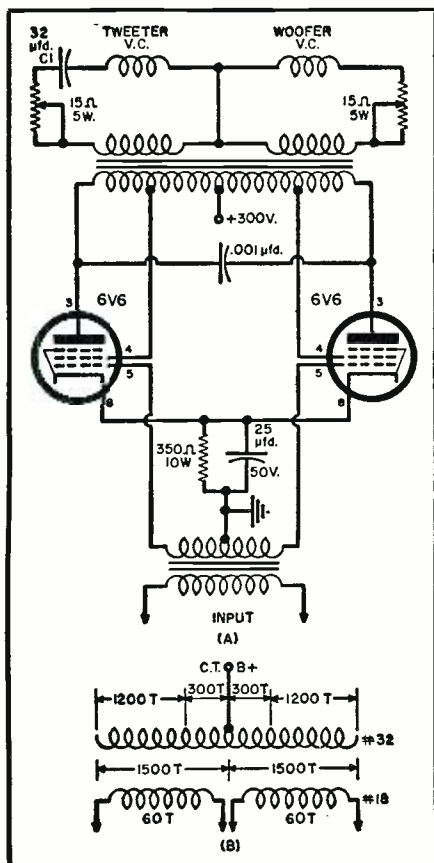
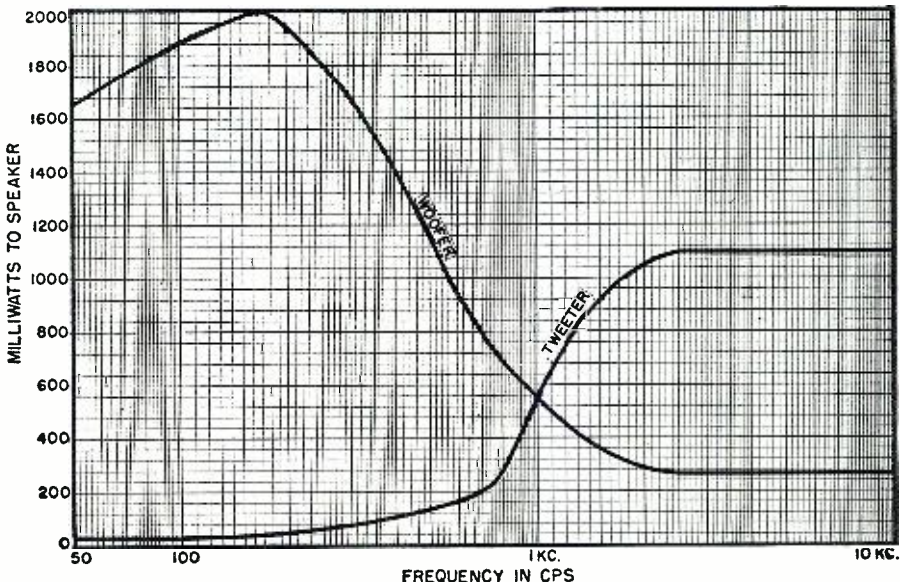
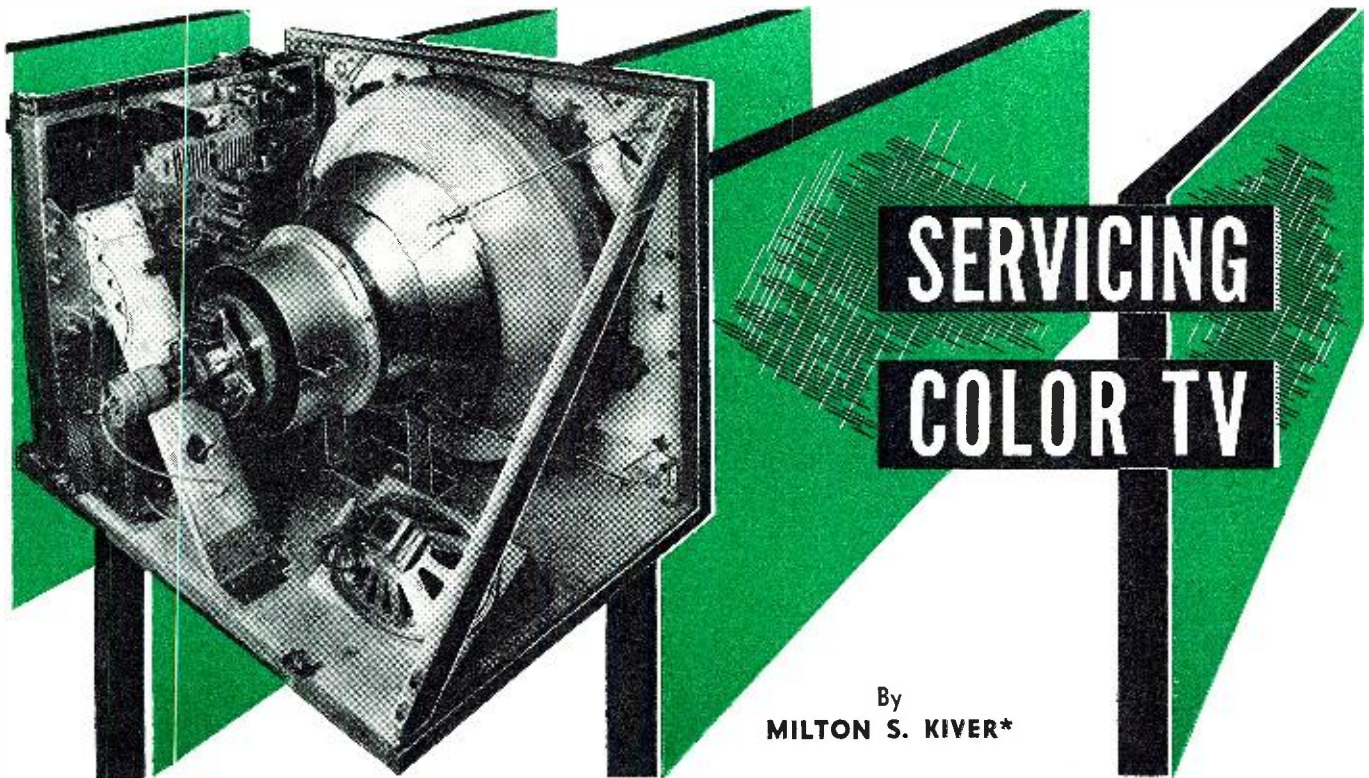

Fig. 2. Crossover curves with added bass boost obtained by feedback from primary taps.





SERVICING

COLOR TV

By
MILTON S. KIVER*

View of the new RCA 28-tube, 21-inch color TV receiver. Note the absence of a field neutralizing coil around the outer edge of the color tube.

Part 1. Large screen color TV is here now! Here are servicing techniques based upon experience with the commercial color TV receivers on the market today.

IN A PREVIOUS series of articles, we investigated the basic operating principles of color television receivers, using typical circuits taken from receivers which have been exhibited to the public. All this has been, in a sense, a forerunner for the job that the service technician will have when color sets are placed in the hands of the public in quantity—the job of servicing these receivers and of nursing them back to good operating condition.

The color television receiver, we have seen, contains many more circuits than a black-and-white receiver. This does not necessarily infer that color sets will be proportionately more difficult to service. Undoubtedly they will present more problems, but experience has shown that much of this difficulty can be reduced if the technician appreciates the differences between monochrome and color sets and develops a logical approach based on these differences.

Block diagrams of color television and monochrome receivers are shown in Fig. 1. To emphasize the differences between the two systems, every box in the color television diagram which has no counterpart in the black-and-white receiver has been shaded. This immediately reveals that the color sync section, the chrominance circuits, and the convergence amplifier(s) are non-existent in a monochrome receiver. The picture tube has been shown as partially shaded to draw attention to the fact that while it differs considerably from its black-and-white counterpart, still the two have many points in com-

mon. Both use electron guns to develop scanning beams, and phosphor screens to convert this electrical energy into light. On the other hand, the color screen must present three colors in place of one and its structure was altered accordingly.

In the remaining receiver circuits, such as the r.f. section, the video i.f. amplifiers, the sound system, the sync separators, the a.g.c., and the sweep sections, both receivers use substantially the same circuits. Differences here are more a matter of degree rather than of basic form. In the video i.f. system, for example, the response is wider, but it still possesses the same general shape with the same trap frequencies. In the deflection system, principally the horizontal section, more drive is required and more high voltage must be developed but, again, anyone familiar with these circuits in monochrome sets would have little trouble in analyzing the corresponding circuits in color sets. Every bit of knowledge acquired by the technician from his work on black-and-white sets will be of value in servicing color receivers. This is an important fact to remember.

The First Step

The initial step in the servicing of a color receiver starts with the observation of the picture and listening to the sound. If one is affected, but not the other, then we would confine ourselves

to that portion of the receiver which dealt with that particular signal alone. For example, suppose we found the picture normal, but the sound either distorted or missing. Then we would start at the sound-video separation point and proceed along the path followed by the sound only until it reached the loudspeaker. In every color receiver which has been shown to date, sound and video signal separation occurred either in the last video i.f. stage or in the video second detector. All sets operate on the intercarrier principle and consequently, the sound i.f. frequency is 4.5 mc.

The other alternative is for the sound to be normal, but for the picture to be affected. Speaking generally, the video signal travels by itself through the video amplifiers, through portions of the chrominance circuits, through several d.c. restorers and finally, to the picture tube.

Another consideration when the picture is affected is whether it is the picture which is at fault or the raster. If it is the raster which is causing the difficulty, then other circuits would come under consideration, for example, the vertical sweep system, the horizontal sweep system, or the high-voltage section.

Thus, as the initial step in analyzing a defective color television receiver, we see that three major items should be checked. The sound, the video portion of the picture, and the raster. Trouble in any one of these, without a corresponding distortion in either of the two

*Author of "Television Simplified," "Television and FM Receiver Servicing," and other books.

plifier. Beyond this is the matrix, and if we continue to follow the Y signal, we see that it enters the matrix and is distributed equally to each of the color adder stages. This means that the red, green, and blue amplifiers will each receive equal amounts of the Y signal and if nothing happens in any of these sections, then each of the grids in the color picture tube should receive the proper amount of voltage to produce a black-and-white picture. (Note that we do not say each should receive the same amount of Y signal voltage. Actually, in most tubes, the red grid will receive more voltage because of the lower efficiency of the red phosphor. Whether this condition will always be true depends upon the progress made in developing more efficient phosphors.)

Up to the matrix or distribution point of the Y signal, all segments of the signal are kept together. Furthermore, nothing in the video detector or Y video amplifier can affect one color on the screen and not the others. It is only after the Y signal is divided among the red, green, and blue amplifiers that trouble in picture coloring could arise. This would occur if something prevented one of these sections from functioning normally. In the present instance we indicated that the picture had a yellowish overcast. The job, now, is to determine which section contains the defect.

There are several possible approaches to this problem. One would be to remove all of the 6CL6 color video amplifiers. This would remove the picture completely from the screen. Then reinsert one of the tubes, say the red video tube. The picture on the screen should be completely red. If it is, then this tube can be removed and the blue video amplifier tube inserted in its socket. The same picture should appear on the screen, only this time colored completely in blue. For the final test, remove the blue amplifier tube and insert the green video amplifier tube. The image now should be green. Failure of any one of these colors to appear at all or in sufficient strength would indicate that the trouble existed in its section. In the present instance, it was the blue section which was at fault. The green and the red voltages, reaching the picture tube, combined to produce a yellowish image.

The same solution can be achieved much more quickly if the service technician is familiar with the principles of additive color mixing. For example, red and green will produce mixtures ranging from orange to yellow. Green and blue will produce cyan; red and blue will give us magenta. The same facts are indicated on the chromaticity diagram (Fig. 3) and, to a more limited extent, on the color phase diagram (Fig. 4).

Here is how we would employ the chromaticity chart to help us locate the defective section in the case history just discussed. Since the predominant color on the screen was yellow, we would locate the general area occupied by yellow on the chromaticity diagram.

See Fig. 3. Now, with your finger at this point, trace out a straight line to white and beyond this, to blue. Blue is the complementary color of yellow since blue added to yellow will produce white. Thus, blue is obviously missing from our picture and investigation of the blue channel is indicated.

The complementary color of cyan or bluish-green can be found in a similar manner. Place your finger on the area marked "bluish-green" and move it on a line through white. The color you meet on the opposite side of white is among the reds, hence red is the complementary color of cyan. For magenta, or reddish purple, the complementary color is green.

The same information is contained in the color phase diagram of Fig. 4. Yellow is located between red and green. Also, blue is at the opposite end of the yellow line, this being the position of the complementary color. The same procedure applies for other colors.

Thus, being familiar with color mixing is especially helpful to the color receiver technician. In fact, it is a good idea to have a chromaticity chart and a color phase diagram pinned up over your workbench for quick reference.

The statement was made that the receiver should be checked on a black-and-white picture before any check is made on color. This can be done even when receiving a color broadcast by disabling the color section of the set by removing the bandpass amplifier tube. This will prevent the color signal or the color burst from reaching the color sync or chrominance sections and actuating them. The result will be a black-and-white picture.

When a receiver gives normal indications on the raster test and with a black and white signal, then we know that in addition to the sections previously listed as being normal, we can now add the entire "Y" channel, plus the matrix, plus the color video amplifiers that follow the matrix. As the reader can well appreciate, this represents a fair-sized section of the set. (It is possible for the delay line to be defective and escape disclosure with the tests prescribed. More on this in a succeeding article.)

A precise method of determining whether each of the color video amplifiers is operating as it should is to measure the gain of each section. The check can be made by using a low-frequency signal generator and an oscilloscope. A frequency around 50 kc. is satisfactory. Connect the generator to the control grid of the red video amplifier (Fig. 2) and connect the vertical input terminals of the oscilloscope between the red grid of the picture tube and ground. Turn all the equipment on and adjust the signal generator until the 50 kc. sine wave appears on the face of the scope screen. Measure the peak-to-peak value of this wave after it has been adjusted to a suitable height on the screen. The measurement may be made with the scope only if such a facility is available or an external voltage calibrator may be employed.

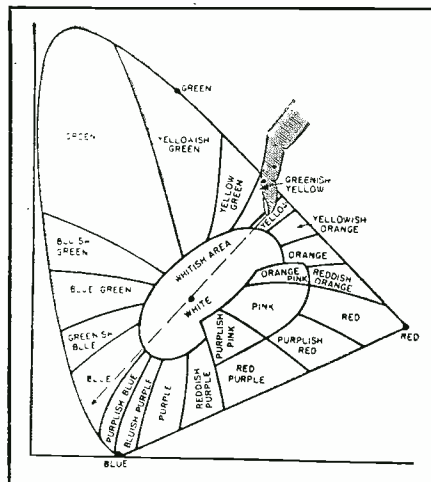

Fig. 3. Chromaticity chart being used to find the complementary color of yellow.

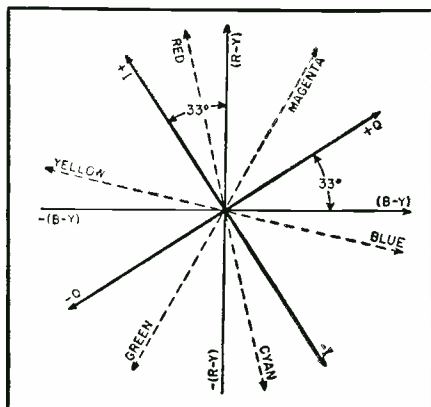

Fig. 4. A color phase diagram, such as shown here, may be used to find complementary colors for servicing applications.

Now transfer the scope to the control grid of the 6CL6 video amplifier and measure the peak-to-peak value of the applied signal. This figure, divided into the previous figure, will give the overall gain of the entire video system. If the manufacturer furnishes this information then a precise check can be made of the operating conditions of these amplifiers.

Raster Colored

Thus far we have assumed that the raster is a normal gray when observed by itself, without the presence of a picture. It is possible that this will not occur and that the raster, when viewed, will be colored or tinted. Let us see under what conditions this can occur and what can be done to correct it.

The components which affect or govern the shading or coloring of a raster (and subsequently, the coloring of a picture) are the purity coil, the electron guns, the voltages on each electron gun, and the d.c. and dynamic convergence controls. Let us consider each, in turn.

The purity coil is mounted near the base end of the picture tube and its purpose is to guide the electron beam from each gun to the correct color dots. That is, the green beam (*i.e.*, the beam from the green gun) should strike only

(Continued on page 155)

ELECTRONIC BUTLER

By JAY J. LUCAS

Fig. 1. Over-all view of the "Electronic Butler." It is built on a Masonite "chassis" which is mounted on one of the cabinet covers.

THE disadvantage of a porch light is that it is usually off when you arrive home after dark. The switch being indoors, makes it necessary to get inside to turn it on, at which time it is no longer needed. After much struggling to find the keyhole in the dark, the author decided to build an electronic device to turn the light on from the outside and keep it on long enough to get indoors, then turn it off automatically.

The basic requirement for any electronic servant in the author's home is that it doesn't eat when it isn't working. With this requirement in mind, the idea of the "Electronic Butler" was conceived and brought into being on the workbench.

In the author's home, one "Butler," stationed at the front door, controls the light for guests when they arrive and depart, and is operated by a switch-mat. Another one was installed at the back door for the convenience of the family, and operates from a push-button outside the door. The time cycle is sufficiently long to see to get

into the house, to the car, or the street, before the "Butler" turns the light off. Time delay begins after releasing the button or stepping off the switch-mat. The timer does not interfere with normal use of the light switch.

The circuit employed in the "Electronic Butler" is appropriately called a "suicide circuit" because the device kills itself at the end of its cycle, filament power being supplied through its own plate circuit relay. When the time delay causes the relay to drop out, the filament circuit opens and the "Electronic Butler" "drops dead."

Besides its suicidal tendencies, the circuit differs from most conventional electronic timing devices by having its grid bias begin at zero, increasing toward cut-off with time. Usual practice is to start the timing cycle with the tube biased at or beyond cut-off, allowing the charge on the RC network to leak off, with return to predetermined conductivity ending the cycle.

The timer described is unique in that although it employs a filament-type tube, it consumes no power when not in use. The device will turn an outside light on or off as desired or may be adapted for other electronic control applications.

Rapid take-off with a cold tube is obtained by applying an "accelerating voltage" to the filament, returning the voltage to normal when the tube conducts sufficient current to close its plate relay. Voltage for the RC time-delay circuit is obtained from a selenium rectifier connected at an appropriate point on the filament dropping resistor. Operation is started by a relay and is self-sustaining during the time cycle.

In view of the possibility that someone might press the button only momentarily, a quick-heating tube was needed to insure fast take-off. A logical choice lies among the several battery power pentodes capable of handling sufficient current to operate the plate relay. The author uses a 3A4, although a 3Q4, 3S4, or 3V4 could be used with appropriate changes in the filament dropping resistor.

Circuit Description

The circuit diagram for the "Electronic Butler" is shown in Fig. 3. The starting relay, RL_1 , operates from the doorbell transformer and is connected to the doorbell wiring. When the timer is idle, the a.c. line voltage appears at one of the open contacts of this relay, through the normally-closed contact on the plate circuit relay, RL_2 . Closing the starting relay applies line voltage to $R_1-R_2-R_3$ at a point selected to apply accelerating voltage to the tube filament. This causes the tube to conduct quickly, closing the plate circuit relay which transfers the line voltage to the end of the line dropping resistor, reducing the filament voltage to normal. The other contacts on RL_1 ground the grid of the control tube, preventing C_2 from charging until the starting relay is released. It is also used for recycling the timer during operation.

Fig. 2. Graphic representation of timer operation. Starting relay is closed for 1 sec.

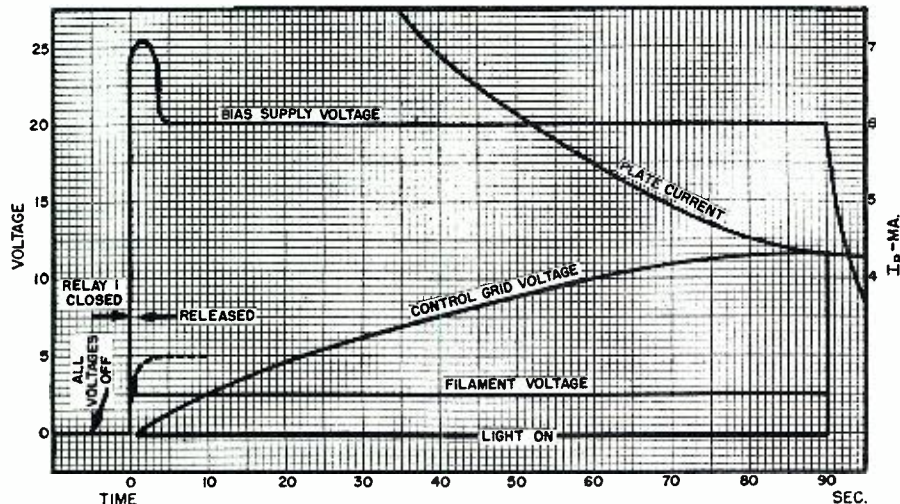

The time delay begins as soon as RL_1 is released. Bias on the control grid is developed across C_3 , with R_3 limiting the charging rate. Charging voltage is supplied by a reverse-connected selenium rectifier which is connected to the filament dropping resistor at a point approximately 15 volts from ground. As capacitor C_3 is charged, increasing bias on the control grid decreases the plate current. When sufficient bias has developed, the plate circuit relay opens, disconnecting the line voltage from the filament dropping resistor. At this point, the "Butler" has "hung itself" and the circuit is again idle.

The operation of the timer is shown graphically in Fig. 2.

The timer may be recycled during operation without re-applying the accelerating potential. Closing RL_1 before the circuit has reached the end of its cycle merely discharges C_3 so that the bias build-up must be repeated. R_4 acts as a current limiter to prevent arcing at the contacts of the starting relay.

Construction

The method of construction is easily seen from the photograph, Figs. 1, 5, and 6. All parts are assembled on a *Masonite* hardboard sub-panel measuring $3\frac{1}{8} \times 4\frac{1}{8}$ inches which just clears the flanges on a *Bud* $3 \times 4 \times 5$ inch utility box. After construction has been completed, the sub-panel is centered on one of the 4×5 cover plates using $\frac{1}{2}$ inch spacers. The lugs on the tube socket should be bent so as to clear the panel, and a thin piece of insulating material should be fastened to the metal panel under the tube socket to prevent accidental short-circuiting.

The exact location of the parts will be determined by the size of the parts used, and they will have to be placed carefully in order to fit into the space provided. All parts should be mounted before wiring is started, as the terminals on the components will serve as tie points for most of the wiring. Capacitors C_2 , C_3 , and resistor R_5 are

mounted between studs made from small brass machine screws installed through the insulated sub-panel. The studs also serve as feedthroughs to connect the RC circuit to the tube socket.

The line dropping resistor R_1 - R_2 - R_3 , is made up of three 500-ohm, 10-watt adjustable resistors which are mounted between brackets as shown in the photographs. (Note: in case other tubes, mentioned earlier, are used, 1000-ohm resistors must be used).

Adjustment

When wiring has been completed, R_1 - R_2 - R_3 should be adjusted for correct operating conditions. Preliminary settings are shown in the diagram and may be set with an ohmmeter, but final adjustment should be made with the device in operation. This is easily accomplished by putting the "Electronic Butler" in a "straight jacket" to keep it from "committing suicide." For adjustment of the accelerating potential, RL_2 should be blocked open to prevent line voltage transfer to the normal voltage contact. Voltage is then applied by closing the starting relay. After adjusting the accelerating voltage tap for 5 volts across the filament, RL_2 should be unblocked. The normal filament voltage and bias taps may now be adjusted by blocking RL_1 closed to keep the timer in cycle for a prolonged time. The bias tap is adjusted to provide -20 volts d.c. at the output of the bias supply, and the filament tap adjusted for 2.5 volts. This will be an a.c. voltage.

Values of R_5 and C_3 were chosen to provide approximately 90 seconds delay with 20 volts input. The length of the cycle will depend on the bias voltage and may be adjusted for up to 4 minutes by reducing the bias voltage. If a longer delay is desired, C_3 should be changed to a higher capacity, rather than increasing the value of R_5 . Any substantial increase in R_5 would limit the charging current to less than the leakage through C_3 , thus preventing a charge from accumulating on the RC

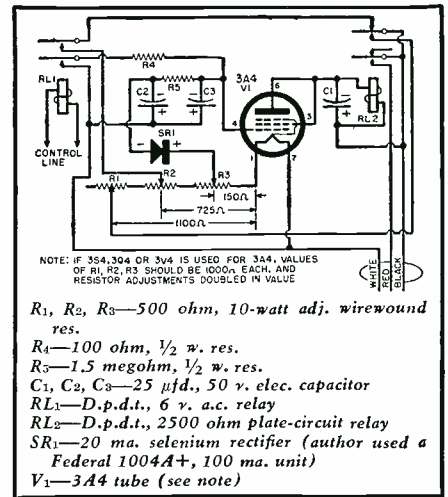

Fig. 3. Complete schematic of "Electronic Butler." Circuit is of "suicide" type and draws no current when device is inoperative.

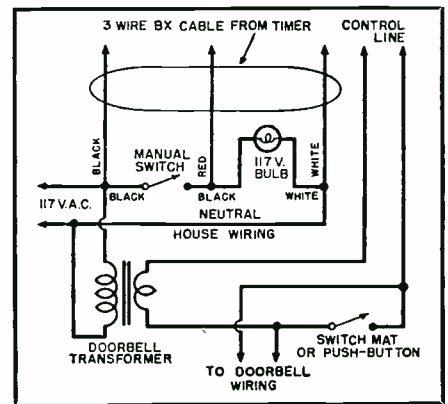

Fig. 4. Power line wiring arrangement. Operation of the unit is basically such that it connects to the 117-volt line through a relay from the black wire to the red wire of the 3-wire BX cable. This puts 117 volts across the exterior light. The outdoor light can be controlled manually by means of the s.p.s.t. "Manual Switch." This automatically shunts out the "butler" circuit.

circuit. This difficulty could be eliminated by substituting a paper capacitor. (Continued on page 104)

Fig. 5. The "Electronic Butler" with the cover removed. The red and black wires from the BX cable terminate at relay terminal.

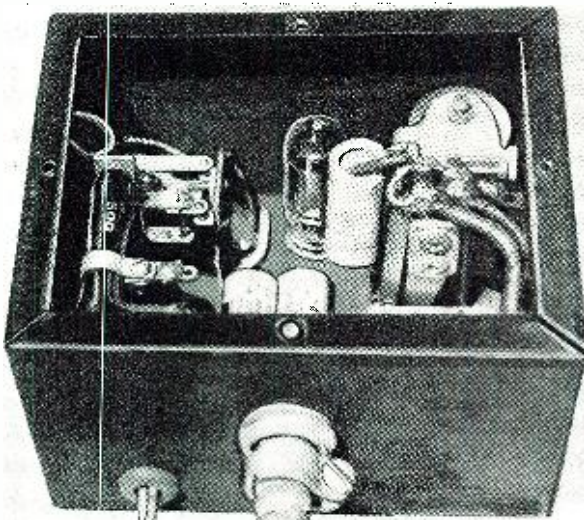
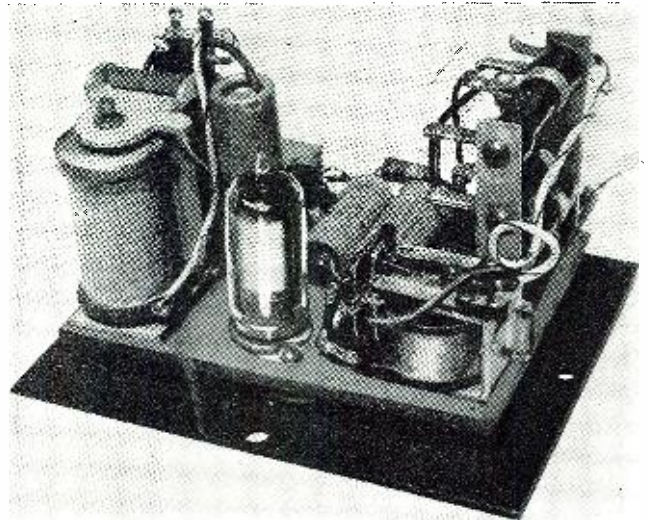
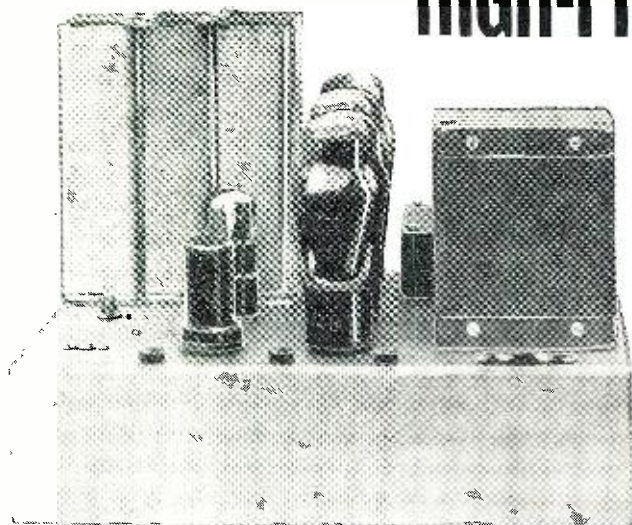

Fig. 6. Three resistors (mounted on bracket at right) are R_1 , R_2 , and R_3 . R_3 is on top to facilitate bias voltage adjustments.



HIGH-FIDELITY THE EASY WAY



Two views of the 18-watt amplifier. The amplifier and power supply are built on same chassis.

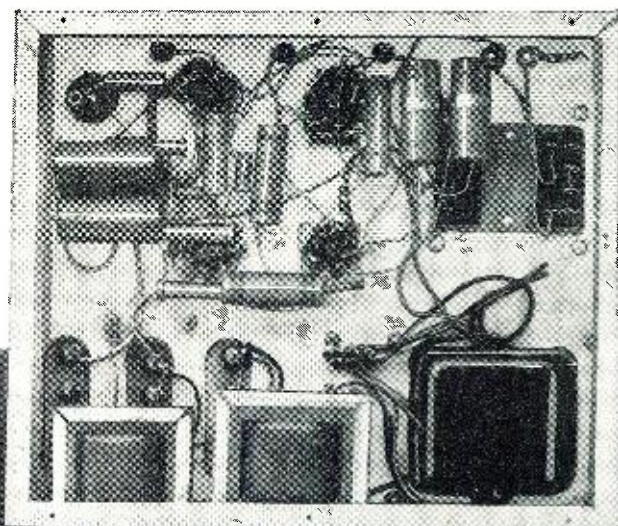

By **COMDR. W. B. BERNARD, USN**

Triodes vs. pentodes—the old controversial question. Here is the author's answer to the problem. The article also includes construction details on an 18-watt amplifier.

OVER the years there have been numerous "fashions" in audio amplifiers. To name a few, past and present, there are the Loftin-White, power pentodes, beam tetrodes, AB triodes, 6AS7G's, the Williamson, and variations on the Williamson. Some of these amplifiers represent or represented good engineering and others do or did not. Since the assessment of the worth of an amplifier is, to a great extent, subjective, it is perhaps a matter of some wonder that the general level of engineering has been so high. Anyone who has been in the radio service business can testify that about 99% of the customers believe that their radios have "wonderful tone" even if they are 4-tube a.c.-d.c. models with magnetic speakers. An analysis of the contemporary literature divides the amplifiers described into several classes, of which the two largest are: (a) the ones "completely free of engineering," which are described by the builder as sounding very good but which are accompanied by no measurements to indicate the results achieved, and (b) the overly complicated types with such features as multiple feedback loops, cross-coupled phase inverters, and other elaborate features which are advocated as the only way to achieve high fidelity. Many of the more complicated circuits are also unaccompanied by data to indicate their advantages over the simpler circuits, and sometimes an analysis of the circuit will indicate that the advantages are not present.

It seems timely to dispel some of the superstitions which make for over-complicated, over-expensive, and poorly engineered amplifiers. This amplifier was developed to show that a little engineering can replace a lot of complexity. Its over-all performance will equal or surpass that of most of the more complicated circuits; the output tubes are operated at conservative voltages requiring a less expensive

power supply and giving longer and more stable tube life; it is quite stable; and it has no critical adjustments which must be made regularly if it is to operate properly.

It is widely believed that only triodes make good output tubes. This was, to a great extent, true before the days of inverse feedback, but it certainly is not true today. Power pentodes were rightly accused of having more high order distortion than triodes. This can be judged by inspection of the characteristics of typical triodes and pentodes. The tube characteristics shown here were taken from the RCA "Tube Handbook HB-3," and are included in this article by permission of RCA. Fig. 1A shows two load lines plotted on the characteristics for a 6L6 triode connected. As we proceed along either load line from 0 volt to -45 volts, we see that the change in plate current or plate voltage for each 15 volt increment in grid voltage decreases as the grid voltage becomes more negative. If we then plot a curve of plate current vs grid voltage and develop the result of a sine wave fed into the grid circuit, we see that one-half of the sine wave is somewhat flattened, which is an indication of even harmonic distortion. Fig. 1B is such a plot for the triode-connected 6L6. In Figs. 2A and 2B we see a similar development for a 6K6 pentode. In this case the sine wave appearing in the plate circuit is flattened on both peaks, which indicates odd harmonic distortion. Figs. 3A and

3B show that the output of a single 6L6 tetrode contains mainly even harmonics like those produced by a triode.

With triodes, pentodes, or tetrodes, the operation of two tubes in push-pull tends to cancel the even harmonic distortion. Fig. 4A shows that the grid-to-plate transfer characteristic of push-pull 6L6's is so straight that no curvature can be detected. As a confirmation, the RCA "Tube Handbook" states that push-pull 6L6's class A will give 18.5 watts output at 2% harmonic distortion. There are no receiving triodes which equal this performance.

Beam tetrodes, like pentodes, have a high plate resistance which is undesirable when the amplifier is being used to feed a variable impedance load such as a speaker system; however, a very small amount of inverse feedback will reduce the output impedance to that of a triode. Fig. 4B shows the result of applying 1/15th of the output of a 6L6 as inverse feedback. This would amount to about 6 db for a normal load impedance. The slope of the lines shows that the plate resistance has been reduced from about 25,000 ohms to about 1750 ohms. If the feedback is applied to some electrode other than the screen grid, it will not reduce the maximum output of the stage. At the same time that the inverse feedback reduces the output impedance, it also reduces the distortion. We now have an output stage with lower distortion, lower output impedance, and higher plate efficiency than a triode output stage.

This inverse feedback sounds so good that it might seem that we couldn't get too much of it. This would be true if the feedback always remained inverse, but at the extreme frequency ranges of the amplifier there may be an 180° phase shift in the amplifier which causes the feedback to be positive, which can cause oscillation. To avoid difficulty resulting from this phase shift, we need the opposite of the situation that we would desire if we were designing a phase-shift oscillator.

In a phase-shift oscillator it is theoretically impossible to get oscillation with one or two RC network stages. Fig. 5 shows vector diagrams for 3- and 4-stage phase-shift networks. As can be seen from Fig. 5, as the number of network stages is decreased, the loss of the network at the 180° phase-shift frequency is increased and it becomes more difficult to sustain oscillation. It can also be seen that the gain required for oscillation is at a minimum when the phase shifts of the stages are identical. Since we wish to avoid oscillation we should have the minimum number of stages within our feedback loop, and these stages should have different cut-off frequencies.

For numerous reasons it is most desirable to use a push-pull output stage. Push-pull stages greatly reduce even harmonic distortion, they cause less feedback through the plate supply system, and there is a variety of excellent output transformers available to use with push-pull stages. Because there is a large price differential between the 20-watt size of transformer and the next larger size in most manufacturers' lines, and because 20 watts is more than adequate for home use, we may put a limit of 20 watts on the output of our amplifier. Next, we should consider the most economical means of producing about 20 watts at low distortion. As mentioned previously, a pair of 6L6's will give 18.5 watts output with a 300-volt power supply. This output cannot be equalled by any triode circuit without going to AB₂ operation—push-pull parallel connection requiring a high current power supply—or to special tubes requiring more expensive high voltage power supplies. For these reasons push-pull 6L6's appear to be the best choice for our amplifier.

In order to drive a push-pull stage from a single-ended input we must have some type of a phase inverter. For this purpose we choose a tube because good input transformers are quite expensive and transformers contribute excessive phase shift at frequency extremes. It is also necessary to have a voltage amplifier to produce enough gain to drive the output stage from the voltage available from the usual preamplifier and tone control system, and to build up gain to be reduced by inverse feedback. We need about 15 volts r.m.s. to drive one 6L6. The usual types of phase inverter have a gain of about unity from grid-to-plate, so we will also need about 15 volts r.m.s. to drive the phase inverter.

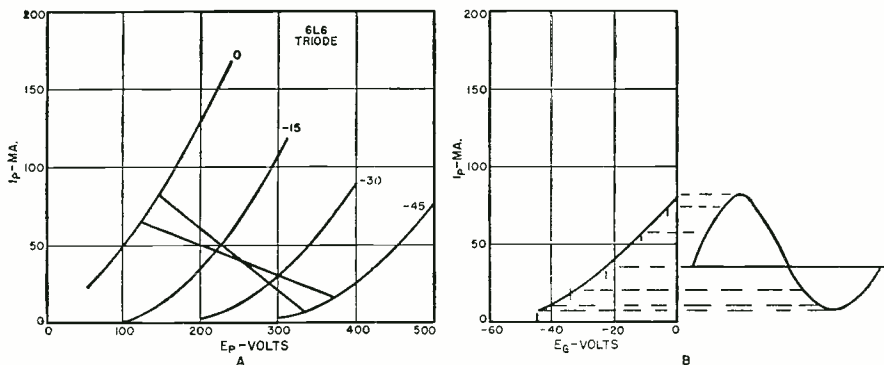

Fig. 1. (A) Two load lines plotted on the characteristics of a 6L6. (B) The transfer characteristic of a 6L6 triode, 4000 ohm load. Courtesy of Radio Corp. of America.

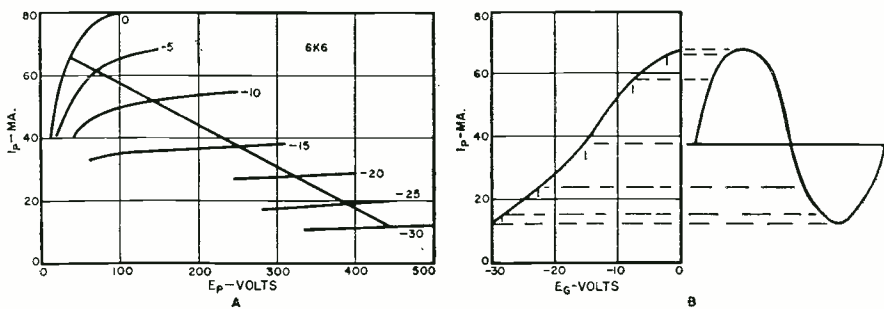

Fig. 2. (A) Characteristics for 6K6 pentode. (B) Transfer characteristics, 7500 ohm load. Note sine wave is flattened at the peaks, indicating odd harmonic distortion.

If we precede the phase inverter by an amplifier stage with a gain of 50, it will require 0.3 volt r.m.s. to drive the amplifier to full output. If we then allow for the gain reduction of 20 db to permit that amount of inverse feedback, we will need 3 volts r.m.s. to drive the completed system to full output. This 3 volts is well within the capabilities of most input amplifier systems.

Fig. 12 is the schematic diagram of the completed amplifier and associated power supply. A pentode was chosen as the voltage amplifier because with a pentode it was possible to achieve about twice as much gain as with a triode. A 6SH7 was selected from the many types of tubes tried for this purpose because it gave the required drive voltage with low distortion, and because it was less critical in regard to the adjustment of screen voltage for lowest distortion. The 6SH7 is coupled to a 6SL7 phase inverter by a step circuit, which gives 6 db attenuation and almost no phase shift at very low frequencies.

This circuit has an advantage over direct coupling in that more favorable d.c. voltages can be applied to the voltage amplifier and the phase inverter, and in addition it inserts 6 db attenuation at d.c. and at very low frequencies. It is superior to straight RC coupling in that the phase shift is very low at low frequencies.

The split-load phase inverter was chosen as the circuit which would give the least phase shift at both very low and very high frequencies. It also has the advantage of contributing very little distortion because of the large amount of current feedback produced by the cathode half of the load. To produce a favorable a.c. to d.c. load ratio, and to maintain balanced drive at high frequencies, 22,000 ohm load resistors are used in the 6SL7 plate and cathode circuits. The two halves of the 6SL7 are operated in parallel to furnish sufficient current to these low value resistors. 50 ohm resistors are connected between the grids and between the plates of the 6SL7 to prevent parasitic oscillations.

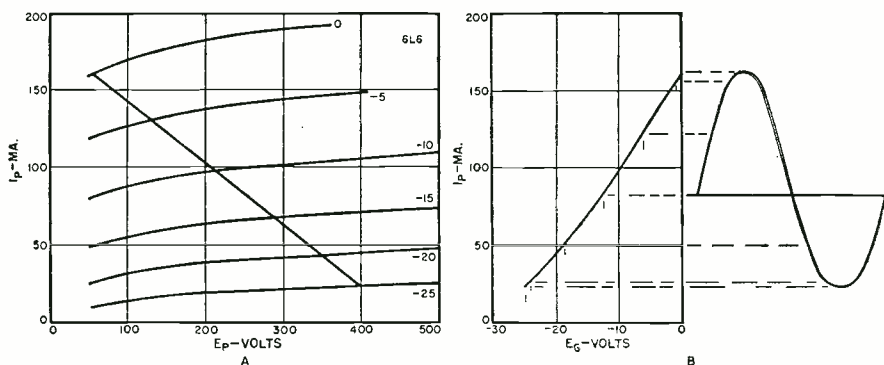

Fig. 3. (A) Characteristics of a single 6L6 tetrode. (B) Transfer characteristic, 2500 ohm load. Output contains principally even harmonics similar to those in Fig. 1.

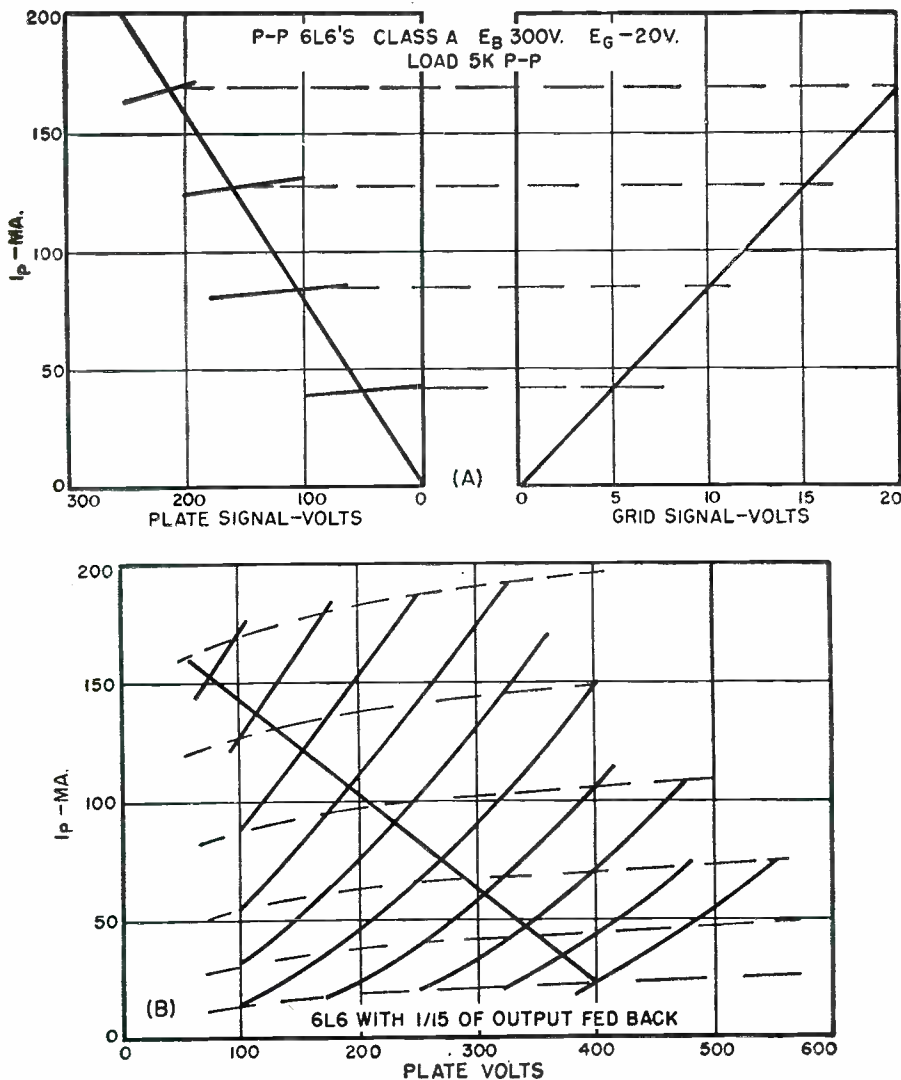
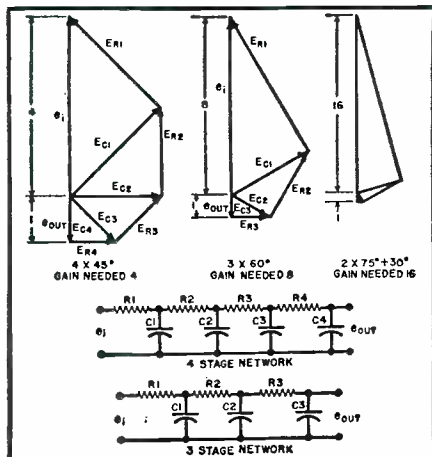

Fig. 4. (A) Grid-to-plate transfer characteristic of push-pull 6L6's. (B) Curve obtained when 1/15th of the 6L6's output is applied as inverse feedback. See article.

One set of recommended conditions calls for operation of the 6L6 plates and screens at 270 volts. Adding 25 volts for cathode bias we then require 295 volts from the plate supply system. A 375-0-375 volt transformer with the rectifier operated into a choke input filter will give approximately this voltage. The choke input system gives very

Fig. 5. Vector diagrams of a 3- and 4-stage phase-shift network and circuit diagrams of the networks involved.



good regulation thus obviating the necessity for an elaborate method of regulating the output tube screen voltage. This superior regulation also reduces the undesired feedback of low frequency energy from the output stage to the early amplifier stages through the plate supply.

Although the handbook specifies a 125-ohm cathode resistor for class A 6L6's, the distortion at medium output levels is considerably reduced by increasing this resistor to 250 ohms. A metering circuit is provided to check the balance of the 6L6 cathode currents. This is used to determine when one or both of the output tubes should be replaced. If more than 0.1 volt is indicated between the two cathodes the condition of the output tubes should be checked. The two cathodes were individually bypassed because it was found that leaving even the 10-ohm resistors unbypassed increased the distortion in the output.

The photographs on the first page of this article show side and bottom views of the unit. The power supply and the amplifier are built on the same chassis. Using a reasonable placement of parts, there should be no difficulty from putting these two units close together.

The hum in the output of this unit is less than one millivolt across 16 ohms. Oil-filled paper filter capacitors were used because they were available very cheaply in surplus stocks. If they are replaced by electrolytics, each section should probably be increased to 20 μ fd. In addition to the test jacks for the output tube cathodes, there is a test jack to measure the screen voltage of the 6SH7. A high resistance or vacuum-tube voltmeter should be used to read this voltage which should be set to approximately 70 volts.

The finished amplifier was adjusted for good square-wave response at 10 kc. This required a 220 μ fd. capacitor shunted across the 10,000 ohm feedback resistor, which almost totally removed the ringing from the top of the square waves. As can be seen in Fig. 6, there is a small highly damped ringing on the leading edge of the square wave. Although most amplifiers having as much as 20 db of over-all feedback become very unstable when a small amount of capacity is placed across the output terminals, a capacity of 0.02 μ fd. across the 16-ohm output of this amplifier makes a barely perceptible difference in the ringing. This is shown in Fig. 8. Fig. 9 shows that the amplifier is still stable with 0.05 μ fd. across the 16-ohm load. Oscillation does not ensue until 0.08 or 0.10 μ fd. is placed across the output.

Fig. 10 shows the response to a step function on a $\frac{1}{2}$ second sweep. This shows that the disturbance is highly damped and is reduced to negligible amplitude in less than $\frac{1}{3}$ second. Fig. 7 shows the overload recovery of the amplifier on a 2 second sweep. Again the perturbations are small and are damped out in less than $\frac{1}{3}$ second. The perturbations shown are very small compared to those produced in most speaker systems. Another indication of excellent transient response is the oscillogram, Fig. 11, which shows a 5 kc. sine wave switched at a 1250 cycle rate. Fig. 13 shows that frequency response has not been sacrificed to attain this stability. To demonstrate stability under unfavorable conditions, the amplifier was operated using only one output tube with the output terminals open-circuited. It is stable under these conditions even when the one tube is driven to overload.

Fig. 14 shows the intermodulation distortion produced by the amplifier using 40 cps and 7000 cps with a 4 to 1 ratio. During this run the test setup had a minimum reading of 0.11% before the amplifier was connected in the system, but even so the resulting characteristic shows that the amplifier is suitable for the most critical high-fidelity use.

It is essential to use a high-quality output transformer in an amplifier using this much inverse feedback. The compensation used to adjust the square-wave response may be different for transformers of different manufacture. If the transformer used is inferior to the Peerless S-240-Q specified it may be necessary to put in additional compensation networks to main-

tain stability with 20 db feedback. Stability can usually be obtained if sufficient frequency response is sacrificed. In most cases a considerable amount of high-frequency response can be sacrificed without any bad effects, but any decrease of low-frequency response inside the feedback loop should be closely examined to make sure that it is not going to reduce, to any considerable extent, the net inverse feedback at any low frequency that it is desired to reproduce.

The low-frequency response input to the grid of the 6SH7 should be limited to remove any frequencies that the speaker cannot handle; otherwise low frequency transients which contribute nothing to the music being reproduced may cause extreme excursions of the voice coil of the speaker. During these excursions the voice coil is usually in a non-linear portion of the air gap flux, thus making the speaker a source of intermodulation or harmonic distortion. In the author's system there is a three-section RC high-pass filter cutting off at 10 cps between the tone control amplifier and the output amplifier. Such a high-pass system also serves to attenuate turntable rumble.

We may now stop and consider if we have sacrificed anything by going to this simpler circuit. With the over-all feedback removed, the distortion at the output grids just before grid current sets in is less than 1%. This indicates that most of the distortion occurs in the output stage and that a more complicated driving system would not make any improvement. There seems to be no reason, therefore, to go to additional stages in the driving system with the attendant danger of instability when 20 db of over-all feedback is applied.

Since we have found that most of the distortion is contributed by the output stage, we may now investigate whether this should be reduced by local feedback. About 4 db of local feedback can be obtained by using an output transformer with "Ultra Linear" taps; however Kiebert¹ has stated that this connection does not reduce the low-level distortion, which agrees with the author's findings. Since the over-all feedback loop will reduce the output impedance of the amplifier to a sufficiently low value, there seems to be no reason to use this type of feedback.

Feedback voltages may also be obtained from one or both of the output tube plates. Feedback from the primary of a transformer has disadvantages. First and most serious is that the hum voltage present at the center of the primary also appears at the plates of tetrode or pentode output tubes. Under ordinary circumstances this causes no hum to be induced in the secondary; however if feedback is used from one or both plates, the feedback will tend to reduce the hum at the plates but it cannot reduce the ripple at the center tap, so there will be currents flowing through the halves of the transformer

(Continued on page 82)

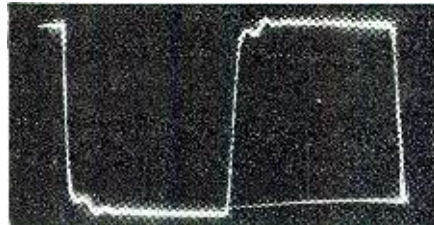

Fig. 6. A 10 kc. square-wave response.

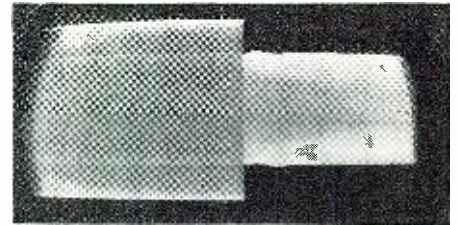

Fig. 7. Overload recovery, 2 sec. sweep.

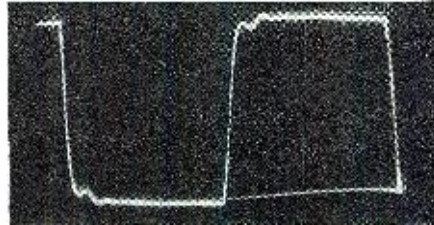

Fig. 8. A 10 kc. square-wave response with .02 μ d. capacitor across output.

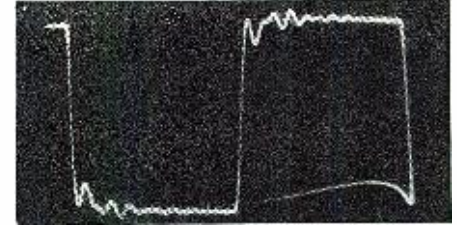

Fig. 9. Square-wave response at 10 kc. with .05 μ d. capacitor across output.

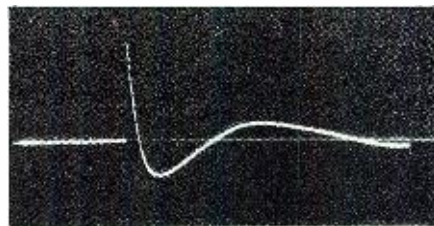

Fig. 10. Response to a step function with a half-second sweep. See details in text.

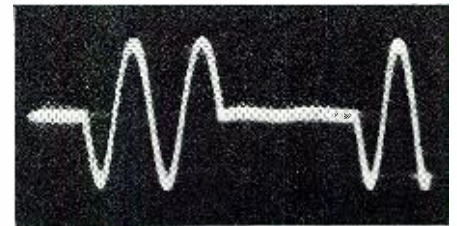
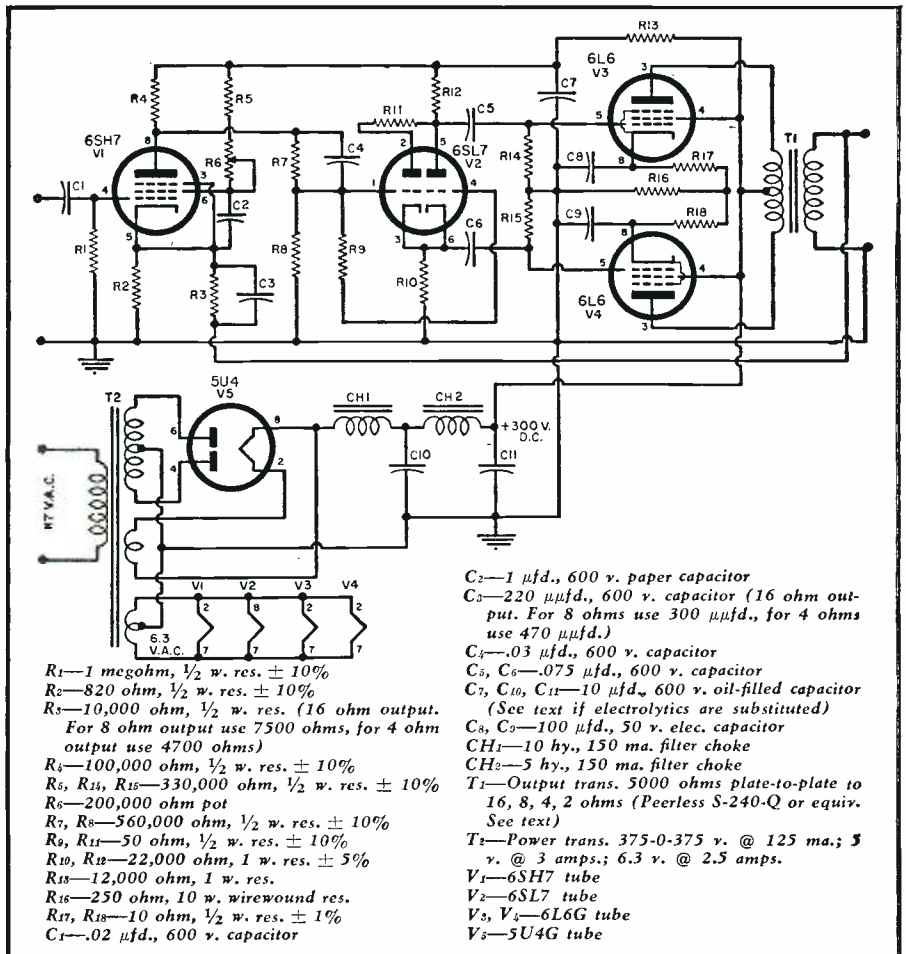
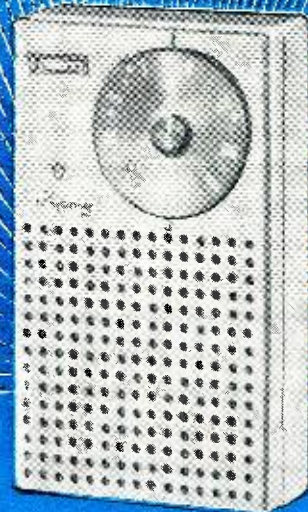

Fig. 11. 5000 cps sine wave switched at a 1250 cps rate. See discussion in article.

Fig. 12. Complete schematic and parts list covering amplifier and its associated power supply. Both are built on same chassis but no troublesome hum developed.



A NEW POCKET RADIO



Slightly taller than a teacup, the new set has no tubes, provides good reception on broadcast band.

This all-transistor broadcast receiver weighs less than twelve ounces and is the first available for consumer use.

THE first pocket radio to use transistors instead of tubes has been produced by *Regency* of Indianapolis and is being marketed currently in the N.Y. and Los Angeles areas.

Slightly taller than a teacup, "Model TR-1" uses four transistors and a germanium diode in a compact superheterodyne circuit. Within its case, measuring 3" x 5" x 1 1/4", the unit contains its own battery power supply, a built-in bar antenna, and a tiny PM speaker.

This first commercial all-transistor set owes its successful design, in part, to the high performance transistor developed by *Texas Instruments Incorporated* of Dallas, who are the first people to mass produce a low cost, high gain, high frequency germanium transistor.

The transistor is a grown junction

n-p-n type. Used in the new pocket radio, it provides power gains of 34 decibels and 40 decibels in the intermediate frequency and audio stages, respectively. Such figures have previously been attainable only in the laboratory.

As shown in the schematic below, the circuit employs only four transistors and one germanium diode. Laboratory models of similar sets have hitherto used almost twice as many transistors. The first transistor, TI223, serves as a frequency converter (local oscillator and mixer). Stations are tuned in by a miniature two-ganged capacitor. The i.f. stages employ two transistors, TI222 type and three tiny i.f. transformers. Audio detection is accomplished by a germanium diode. The audio signal is developed across a miniature 1000 ohm volume control

and thence fed to the fourth transistor, TI210, which serves as an audio amplifier. Sufficient power is developed by this stage to drive the diminutive PM speaker.

Featured in this set is the advantage of long battery life. Because the power consumption is only a fraction of that required for a comparable vacuum tube unit, it was possible to eliminate one battery as well as to reduce the size of the one remaining and still extend its life. This, in turn, effected a reduction in weight and is expected to reduce battery replacement cost.

Another advantage claimed by the manufacturer is the elimination of tubes and the problem of tube replacement. While the hot filament or cathode in a vacuum tube is continually consumed during operation, no similar phenomenon occurs in transistors. Except for physical damage, transistors will last indefinitely.

The new radio was designed by the firm of *Painter, Teague and Petertil*, industrial designers. Miniaturization of components was achieved by a number of organizations. The speaker was produced by *Jensen* of Chicago. The tuning capacitor was made by the *Radio Condenser Company* of Camden, N.J. *The Vokar Corporation* of Dexter, Mich. contributed the i.f. transformers. The volume control was made by *Chicago Telephone Supply Corporation* of Elkhart, Indiana. *Centralab* of Milwaukee engineered a very small ceramic capacitor.

Components were assembled by a semi-automatic process using printed wiring and dip soldering techniques.

Sanford Electronics is handling distribution in New York, while West Coast distribution is being undertaken by *Gough Industries, Inc.* of Los Angeles.

Complete schematic diagram of the new transistorized pocket radio.

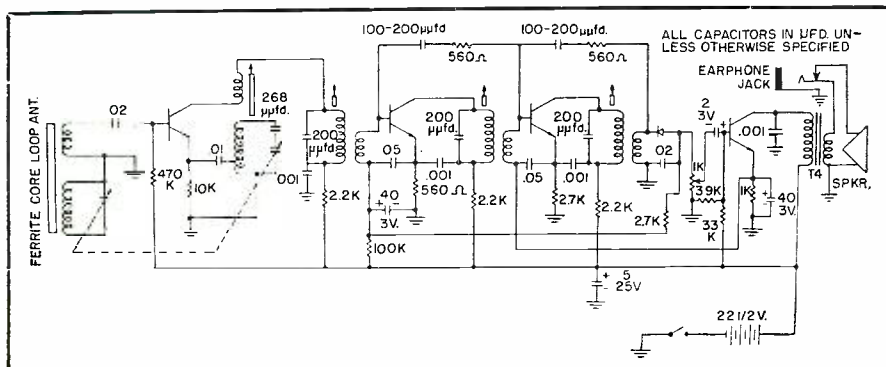
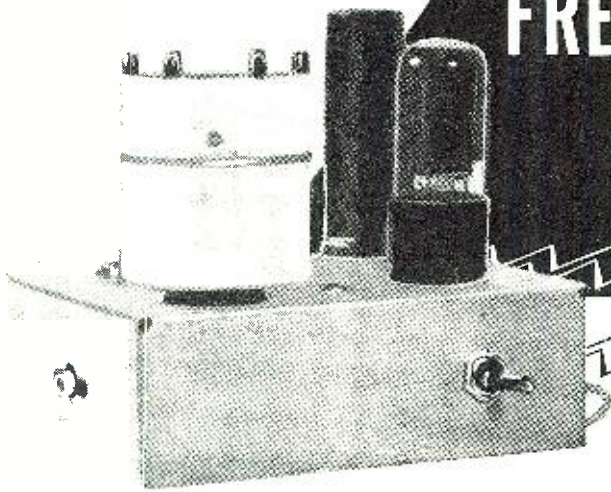

Fig. 1. Front panel view of the author's home-built 100 kc. frequency standard.



FREQUENCY STANDARD FOR THE NOVICE

By

ROBERT J. ROPES, W9PAP

When calibrated against WWV, this 100,000 cycle signal source provides accurate means of transmitter adjustment.

THIS 100 kc. crystal-controlled frequency standard is designed to fill the need for a simple, inexpensive, self-contained unit which can be constructed in one evening. This circuit is a modification of the old *Bliley* low-frequency crystal oscillator circuit, using the pentode section of a 117N7 as the oscillator and the rectifier section as a simple power supply. The circuit will oscillate with any 100 kc. crystal; even a "sluggish" crystal, which may not oscillate at all in a conventional circuit, will perform nicely here. Feedback is obtained from the cold end of the plate and screen r.f. chokes. The out-of-phase voltage is prevented from returning to ground through the power supply by means of the two 2.5 mhy. r.f. chokes in series. The feedback voltage is obtained from the .01 μ fd. capacitor and the .002 μ fd. capacitor voltage divider network. The feedback can be increased by decreasing the value of the .002 μ fd. capacitor. However, this is inadvisable, since the crystal current will rise to an excessive level, and the crystal may fracture.

In constructing this unit, it should be noted from the schematic that the "B—" side of the power supply is *not* connected to the chassis, but is wired to the various "ground" circuit points. The "B—" side of the circuit is then grounded to the chassis through a .002 μ fd. tubular capacitor (C_2). This eliminates the shock hazard which sometimes accompanies the use of an "a.c.-d.c." type of power supply. The electrolytic filter capacitor is insulated from the chassis and covered with an insulating sleeve as noted in the parts list. No special precautions need be observed in wiring the oscillator section, other than to keep the wiring of the crystal and tuning capacitor to the grid as short and direct as possible.

The parts list is complete, and none of the parts is particularly critical except the two iron-core chokes, RFC_1 and RFC_2 . These chokes must exhibit a high "Q" if satisfactory operation is to be obtained. The oscillator plate current, with a plate voltage of ap-

proximately 105 volts, is about 25 milliamperes.

In connecting this unit to a receiver, it is necessary to wrap the output lead around the antenna lead-in several times. Do not connect the output lead directly to the antenna post of the receiver. R9 signals are obtained throughout the spectrum from 100 kc. through 35 mc. This unit, when calibrated against Station WWV, by adjusting the trimmer capacitor C_1 and, when used with a calibrated receiver, meets all requirements of the FCC as far as measuring the frequency of a transmitter. With a unit similar to this, the author was able to meet all the requirements in an ARRL Frequency Measuring Test for Class 1 Official Observer. This oscillator will stay within several cycles of WWV for a period of several hours without adjustment.

To use the unit, first check it against Station WWV. Tune in a WWV transmission on your receiver and turn off the b.f.o. Couple the oscillator to your receiver and adjust C_1 to produce a zero beat.

Next, calibrate your receiver. Turn on the b.f.o. and turn the receiver's tuning dial. Beats will now be heard every 100 kc. Weaker intermediate beats may be heard, but these should be ignored. Record dial readings for zero beat at each 100 kc. check point.

Now your calibrated receiver can be used to determine the frequency of an incoming signal. Turn off or disconnect the frequency standard. Leave the b.f.o. frequency as it was during the calibration. Compare the dial reading for zero beat on the desired station with the check points on either side and determine the frequency by interpolation.

-50-

Fig. 2. Schematic diagram and parts list for the 100 kc. frequency standard. Do not connect "B—" to chassis. Chassis must be connected to external ground for safety reasons. Also, it is not necessary to connect the output lead to the receiver. Best results will be obtained if the lead is merely wrapped a few turns around the antenna lead-in wire of the receiver in traditional gimmick fashion.

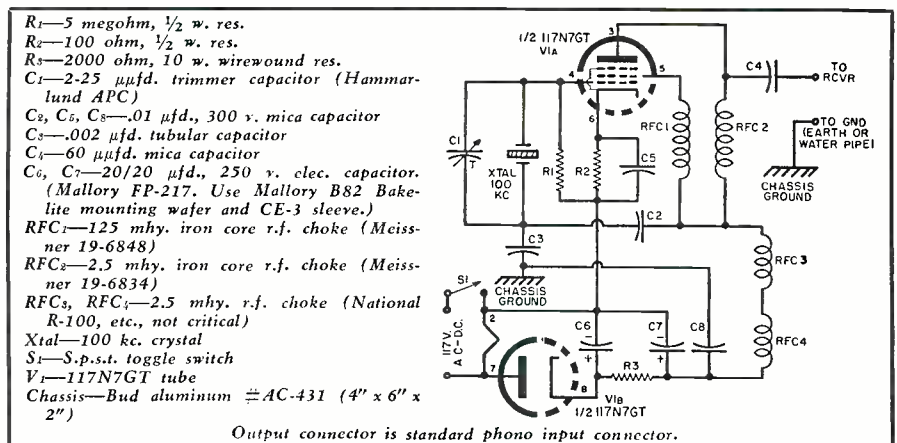

COMBINING POSITIVE AND NEGATIVE

FEEDBACK IN AN AUDIO AMPLIFIER

By DAVID FIDELMAN

Author, "Guide to Audio Reproduction"

A discussion of the advantages of combining feedbacks in amplifiers, along with a practical application of circuit.

ONE of the great advances in the field of audio amplifier design was the introduction of negative feedback. Considerable improvement in the frequency response, distortion, and transient response characteristics is obtained from the proper use of negative feedback and, in many respects, the design of the amplifier is considerably simplified. Beam-power pentodes with feedback in the output stage are capable of performance as good as that of triodes, and their greater sensitivity simplifies the design of the driver amplifier. Also, the feedback will reduce both the noise and distortion introduced by any component within the feedback loop.

However, there are limitations to the improvement which can be obtained with the use of simple negative feedback alone. The distortion introduced within the feedback loop is reduced in the same proportion that the gain is reduced, and is limited by the practical consideration of how much feedback can be applied to the circuit. As the amount of feedback is increased, the frequency range of the amplifier, before the feedback is applied, must be made much wider than it would otherwise have to be. For example, for a frequency range of 40-15,000 cps with feedback, an amplifier with 30 db of gain reduction by feedback cannot be more than 40 db below mid-range gain at 2.5-240,000 cps. For large amounts of feedback, it is often almost as difficult to obtain the required characteristics as to design a suitable amplifier without feedback. Also, there are limits to the improvement in transient response

that could be obtained, even if the amount of negative feedback could be increased indefinitely.

Recent developments in the application of feedback to audio amplifiers have shown that considerable further improvement can be obtained by combining positive and negative feedback in the amplifier. When these feedbacks are properly combined, certain very interesting and useful results are obtained. Only moderate amounts of combined feedback are required to eliminate the major harmonic and intermodulation distortions almost completely; and the source impedance which the amplifier presents to the loudspeaker can be made zero, and even negative if desired, resulting in considerably improved transient response of the loudspeaker. This latter effect cannot be obtained even by the use of great amounts of simple negative feedback.

This article will describe how the performance of the audio system is improved by the application of combined feedback to the amplifier, and simple circuits are given which permit the introduction of positive feedback into existing negative feedback amplifiers. The circuit of a practical amplifier which has been built and thoroughly tested is given, together with performance data showing the improvement which results from combined feedback compared with negative feedback alone.

The importance of the source impedance of the amplifier in improving the transient response of the loudspeaker can best be seen by reference to the electromechanical equivalent circuit of the loudspeaker system, shown in Fig. 2. The linearity of the amplifier is improved, and the output impedance is reduced so that the damping in the loudspeaker circuit is improved.

The importance of the amplifier output impedance in improving the tran-

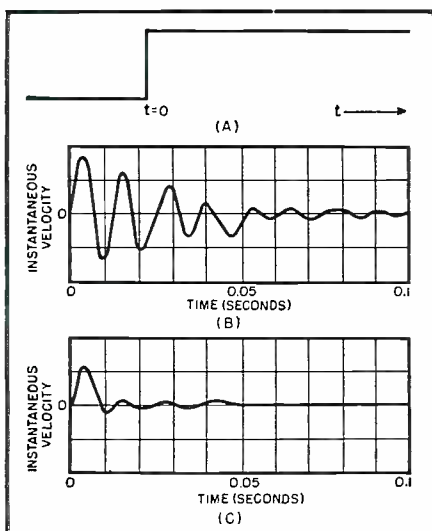
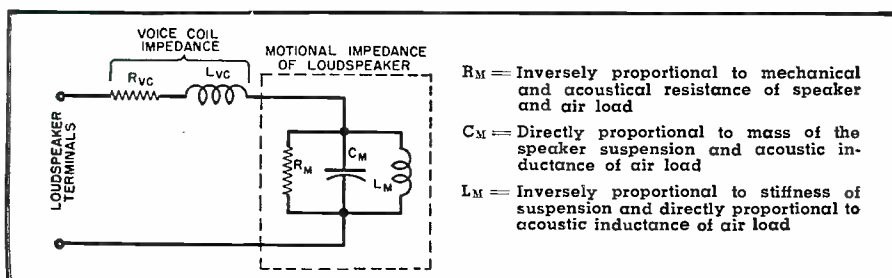

Fig. 1. Response of a loudspeaker to transient signal, illustrating the ringing introduced by the loudspeaker and showing the effects of damping by the amplifier output impedance. (A) Step junction voltage which is applied to speaker to test transient response. (B) Transient response of speaker when connected to an amplifier having high output impedance. (C) Transient response of speaker when connected to an amplifier with low or zero output impedance.

Fig. 2. Electromechanical equivalent circuit which illustrates the electrical and acoustical performance of a direct-radiator type of loudspeaker unit.



R_m = Inversely proportional to mechanical and acoustical resistance of speaker and air load

C_m = Directly proportional to mass of the speaker suspension and acoustic inductance of air load

L_m = Inversely proportional to stiffness of suspension and directly proportional to acoustic inductance of air load

sient response of the loudspeaker can best be seen by reference to the electromechanical equivalent circuit of the loudspeaker system shown in Fig. 2. This circuit represents the electrical impedances due to the amplifier circuit, and the mechanical and acoustical impedances due to the loudspeaker and its acoustical load. The transient response of this circuit is found to be improved when the electrical impedance of the amplifier output circuit is reduced. The degree of improvement may be seen from the curves of Fig. 1, which show the transient response obtained from the same loudspeaker with amplifiers of high and of low output impedances.

The curves in Fig. 1 show, however, that even with an amplifier of extremely low output impedance there will be a certain amount of "ringing" in the loudspeaker when transient tones are applied to it. This ringing cannot be removed even by decreasing the output impedance of the amplifier practically to zero by the use of large amounts of negative feedback. However, it is possible to achieve almost perfect damping by the method shown in Fig. 3. If the amplifier could be made to have a negative output impedance equal to the impedance of the loudspeaker voice coil, then the resulting circuit would be essentially a constant-voltage generator driving a resistive load, resulting in a perfectly damped system. This type of operation can be achieved by the use of combined positive and negative feedback in the amplifier. The manner in which positive feedback is used for this purpose can be seen by reference to the block diagrams of Fig. 4, which show how multiple feedbacks can be included in an amplifier. The system shown in Fig. 4A is a widely used method of combining feedbacks, with the positive feedback loop taken around the low-level stages which introduce the least amount of distortion. The feedback equation for this system is included with the block diagram, together with the standard equations for a single feedback loop, for comparison. The comparison between the two sets of equations shows how certain advantages can be gained from the use of combined feedback.

When the factor A_1B_1 in the system of Fig. 4A is made equal to or greater than unity, the positive feedback loop will oscillate without the over-all negative feedback, but is stable in the complete circuit. When A_1B_1 is equal to unity, the output impedance is zero, and the distortion from the output stage is eliminated. If its value is different from unity, the output impedance may assume negative values and thus subtract from the resistance in the loudspeaker voice coil circuit. For values of A_1B_1 between zero and 2, the distortion from the output stage is reduced, resulting in a considerable reduction in the total distortion, since the major contribution is from the high-level output stages. However,

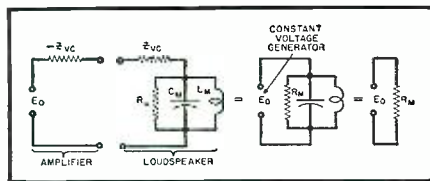

Fig. 3. Method of using an amplifier with negative output impedance to achieve almost perfect damping of the loudspeaker.

the values should not be made greater than 2, since the distortion introduced by the output stage would then be greater than when the positive feedback is omitted entirely.

Certain precautions must be taken when positive feedback is used in this manner. If the sum of the combined positive and negative feedbacks is positive and equal to unity at any frequency, then the amplifier will oscillate at that frequency. At some frequencies far removed from the center of the band, the negative feedback will become positive, and might thus not keep the circuit from oscillating with the positive feedback close to unity. Precautions must therefore be taken to maintain stability and prevent oscillations at those frequencies where the circuit might become unstable. A simple and direct method of accomplishing this is by restricting the use of the positive feedback primarily to the important midband of frequencies, by introducing a phase shift in the positive feedback circuit. This phase shift, in conjunction with the phase shift in the amplifier, reverses the phase at very high and very low frequencies so that it becomes a very small amount of negative feedback. The positive feedback thus tends to prevent oscillations at the extreme frequencies where the negative feedback loop might otherwise become unstable, and is still positive throughout the useful band of frequencies.

A characteristic of this system of combined feedback is that the degree of positive feedback can be adjusted without changing the over-all gain, which is controlled primarily by the over-all negative feedback. (The reason for this is that when the gain of the amplifier without feedback is large, the amplification with feedback is approximately equal to $1/B_2$, and relatively large changes in the amplification within the loop will therefore not appreciably affect the gain with feedback.) Thus the amount of positive feedback can be adjusted for optimum damping without any change in output level which might confuse the measurement. This adjustment can be made while observing the output signal either with the proper test instruments, or by listening to program material by ear. While the adjustment is being made, the distortion in the amplifier will change slightly, but will almost always be so small that it can be neglected.

The principle of combined positive and negative feedback can be applied

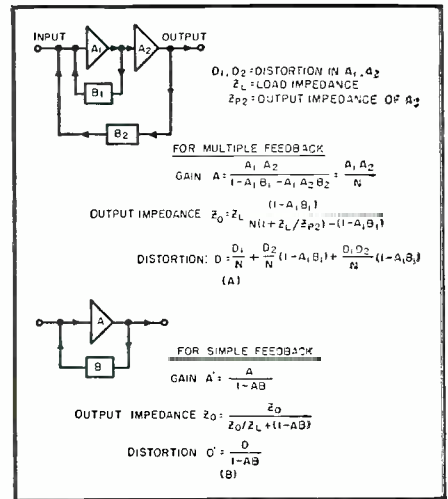

Fig. 4. Comparison of a multiple feedback system with an over-all feedback circuit.

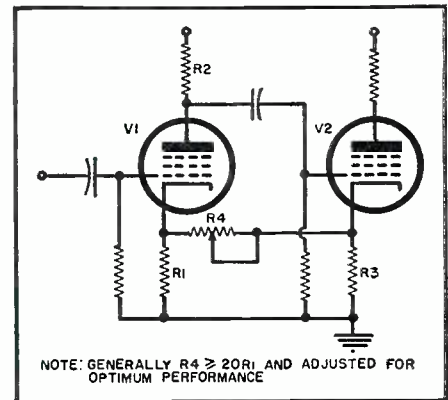

Fig. 5. Simple basic circuit for including positive feedback loop in an amplifier.

to practical amplifiers in a number of simple ways, and can be added to existing amplifiers with only very minor circuit modifications.

A simple basic circuit for obtaining a positive feedback loop is shown in Fig. 5. This type of circuit may be included as a modification in almost any amplifier. The voltage across the unbypassed cathode of one stage is

Table 1. Performance data for the amplifier whose schematic is shown in Fig. 6.

HARMONIC DISTORTION (8 WATTS INTO 3.9Ω SPEAKER LOAD)			
HARMONIC	FREQ. OF INPUT SIGNAL		
	400 CPS	1000 CPS	
2	0.2%	0.17%	
3	0.24%	0.32%	
4	0.045%	0.036%	

(A)

HARMONIC DISTORTION (8 WATTS INTO 3.9Ω SPEAKER LOAD)			
HARMONIC	NO FEEDBACK	NEGATIVE FEEDBACK	POS.-NEG. FEEDBACK
	2	1.4%	0.3%
3	7.0%	2.4%	0.24%
4	0.6%	0.1%	0.045%

(B)

INTERMODULATION DISTORTION 8 WATTS INTO 3.9Ω; 4:1 VOLTAGE RATIO, 60 CPS & 7KC.			
NO FEEDBACK	NEGATIVE FEEDBACK	POS.-NEG. FEEDBACK	
40%	8.0%	1.9%	

(C)

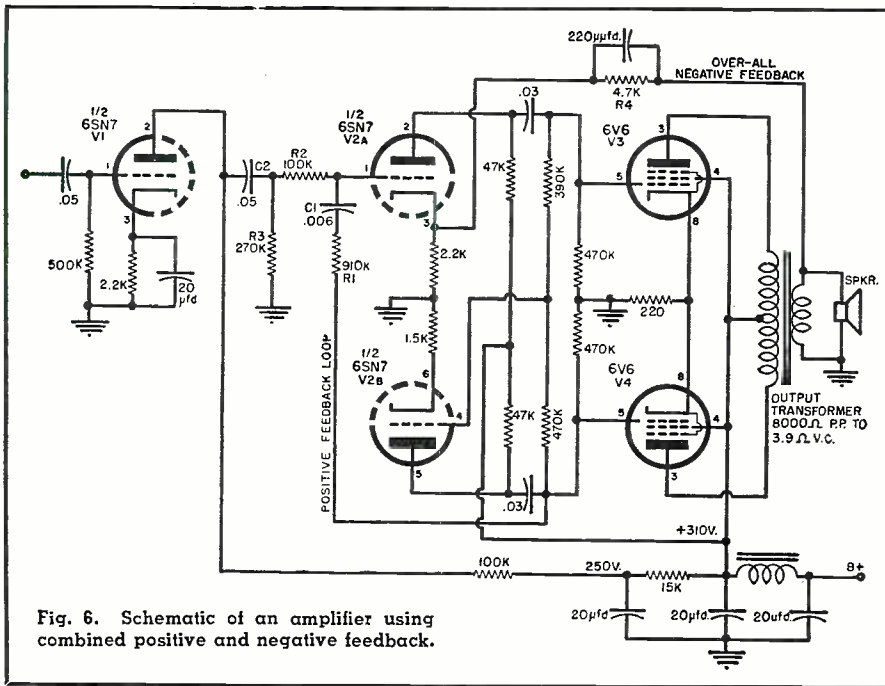

Fig. 6. Schematic of an amplifier using combined positive and negative feedback.

applied through a voltage divider network to the unbypassed cathode of the preceding stage. When a voltage is applied to the cathode of a tube, the voltage variation at the plate is in-phase with the voltage variation at the cathode (for example, a positive voltage at the cathode would be equivalent to a negative voltage at the grid, thus reducing the plate current and causing a positive variation between the plate and ground). However, when an output voltage is taken from the cathode, this output is in-phase with the grid input signal (for example, a positive voltage at the grid results in an increase in plate current and an increase in voltage across the cathode resistor). Thus, the feedback voltage taken from the cathode of V_2 in Fig. 5 is a cathode output signal and therefore in-phase with the grid of V_2 (and plate of V_1), while the feedback voltage applied to the cathode of V_1 is a cathode input signal and therefore in-phase with the plate of V_1 (and grid of V_2).

The feedback as shown in this cir-

cuit can be used as a simple method of obtaining the positive feedback loop for use in a combination feedback system. In a typical amplifier, this feedback might be taken from the cathode of the phase splitter to the previous stage. It is generally not desirable to take the positive and negative feedback to the same point, therefore the negative feedback might be taken to the grid circuit of the stage in which this type of positive feedback connection is used.

The positive feedback can also be included in standard amplifiers in a number of other ways. A typical practical circuit of a complete amplifier using combined positive and negative feedback, which has been built and thoroughly tested, is shown in Fig. 6. Except for the use of the combined feedback, this circuit is quite conventional in design, and may be preceded by any desired low-level amplifier and tone control circuits. It consists of one stage of amplification, a two-stage self-balancing phase inver-

ter (V_{2A} and V_{2B}), and a push-pull power amplifier.

The over-all negative feedback is taken from the secondary of the output transformer back to the cathode of V_{2A} through the resistor R_4 , with a shunt capacity across this resistor for feedback phase correction at very high frequencies. The reduction in gain due to the negative feedback is 9 db, which becomes 11 db when the positive feedback is disconnected.

The positive feedback is taken from the grid of V_4 to the grid of V_{2A} . There is a 180° phase shift from grid to plate of V_{2A} , and another 180° in the phase inverter to the grid of V_4 to make the feedback positive; and since the phase inverter has a gain of unity, it is essentially taken over one stage of gain. (This is different from the method shown in Fig. 5, since the voltages are fed from grid-to-grid, instead of from cathode-to-cathode.) The feedback voltage is developed by a voltage divider network consisting primarily of R_1 and C_1 as the series arm, with R_2 and C_2 as the shunt arm. Because the plate resistance of tube V_1 is low enough and the grid resistance of V_{2A} high enough they can both be ignored. The factor $(1-A_1B_1)$ is very small, since the gain of the loop without feedback is approximately 10, and the positive feedback factor is approximately 0.1. The gain in the positive feedback loop is increased by approximately 26 db. If the negative feedback in the circuit is disconnected, the positive feedback loop will be near oscillation or will oscillate weakly. The output impedance of this circuit is practically zero. If output impedances other than zero are desired, the series R_1 and C_1 values may be changed to give the desired value of $(1-A_1B_1)$ for the desired conditions. (If the values are to be varied for test or comparison purposes, the different component values may be connected to a switch and the different values switched accordingly.) Because of the highly degenerative nature of the phase inverter, the balance is not appreciably affected by the loading due to the positive feedback network.

Phase shift is introduced into the positive feedback network at the extreme frequencies to cause the positive feedback to become negative, and thus improve stability at these frequencies. At high frequencies this phase shift is obtained in the stages V_{2A} and V_{2B} due to the electrode and stray capacities, and to the input capacity of the grid of V_{2A} (although in some designs it may be necessary to add a small capacity from the grid of V_{2A} to ground, or to use a more elaborate phase shift network, to obtain the proper phase reversal in the positive feedback). At the extremely low frequencies the positive feedback current flows through R_3 instead of C_2 so that a phase shift is obtained which, together with the phase shifting action of the coupling capacitors,

(Continued on page 85)

Fig. 7. Frequency response and output voltage regulation of amplifier shown in Fig. 6. (A) Frequency response, .5 watt into a 3.9 ohm loudspeaker. (B) Voltage regulation (in decibels) with a 1 volt output into a 3.9 ohm loudspeaker.

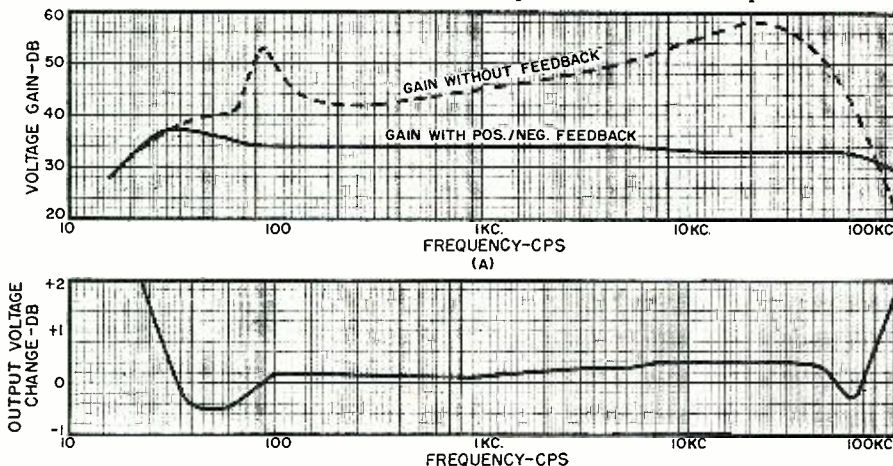

V.T.V.M.

MEASURES CAPACITY

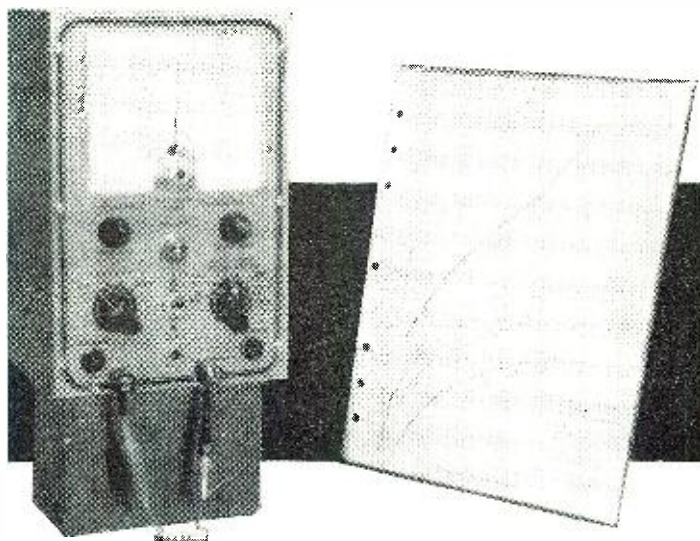

Fig. 1. A v.t.v.m. modified to measure capacitors, as explained in the text, with its calibration chart for translating voltage readings to capacities.

By C. F. POCIUS

A simple v.t.v.m. modification will allow you to measure small capacitors as easily as resistors.

FREQUENTLY the experimenter, service technician, or engineer is baffled by an unscrupulous little ten-cent capacitor with poor or missing markings. Should the baffled one be fortunate in possessing an expensive laboratory-type bridge, his problem can be solved only at the expense of a time-consuming test run on this tiny monster. To be able to measure a capacitor, primarily the "little fellows," with the ease and comparable accuracy of resistance measurements on a v.t.v.m.-ohmmeter is as necessary as the soldering gun to the radio work bench. Higher value capacitors seldom require the precise accuracy of a few micromicrofarads in most electronic circuitry whereas small value micas, ceramics, etc., often do create problems when their accuracy falls off slightly.

The method described here for measuring small capacities from about 1 $\mu\mu\text{fd.}$ to 10,000 $\mu\mu\text{fd.}$ can be applied to almost any vacuum tube voltmeter having an a.c. supply. The simple modification of the v.t.v.m. is inexpensive, and does not interfere with the normal operation or accuracy of the instrument. The accuracy of capacity measurements, however, will largely be determined by the degree of precision the constructor uses in plotting the conversion chart, the number and accuracy of the test capacitors used in calibration, and the careful measurement procedures used thereafter. All that is needed is one resistor, a pair of binding posts and leads, and an hour or two of attentive effort.

The principle of measurement is simple. The voltage drop across a capacitor at a fixed frequency is directly proportional to the current flow. Within the v.t.v.m. we have a fixed voltage source (from the power transformer) and a fixed frequency (60 cycles). With these two constants at hand, we can determine capacity if we can measure the current flow. Where small capacities are to be measured, this current will be quite small. However, the a.c. voltmeter in the v.t.v.m., requiring little current for operation, will measure

this current flow and indicate an a.c. reading in direct relationship to the capacitance up to the value of the voltage source. It was found that a value of around 100 volts a.c. will produce a reading down to one $\mu\mu\text{fd.}$ with surprising accuracy provided certain precautions, described later, are observed.

The modification shown in Fig. 2 applies to a *Heathkit* v.t.v.m. Model V-4A. A similar method of obtaining an a.c. voltage on the front panel could apply for other makes of v.t.v.m.'s. A 56,000-ohm, half-watt resistor protects the power supply of the v.t.v.m. against inadvertent shorts. The binding posts were installed using mica insulation in order to prevent stray leakage currents from upsetting the readings. After installation of these components, the instrument is replaced in its case, and all test leads removed. Fig. 1 shows the panel arrangement.

Several precautions should now be observed before calibration is attempted:

1. The instrument should be grounded directly to the 117 v.a.c. power line conduit, or other suitable ground, to prevent body capacity from interfering with the measurements.

Fig. 2. Method for obtaining 115 volts a.c. for capacitor measurement from the power supply of the modified v.t.v.m.

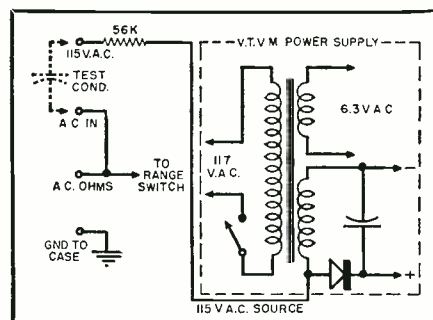

2. Short leads, 3 inches or less, soldered to insulated alligator clips should be attached to the binding posts as shown in Fig. 1.

3. Using the proper a.c. voltage scale, connect the a.c. voltage source directly to the a.c. input terminals and note the reading. Line voltage variations will affect subsequent measurements. Therefore, this reading should be used for correcting the supply voltage, either by means of a "Variac" if one is available, or by applying a proportionate correction to the measurement reading before entering it on the calibration curve. This correction will be quite small for normal line voltage variations. (Continued on page 112)

Fig. 3. Calibration chart used with the modified v.t.v.m. shown in Fig. 1.

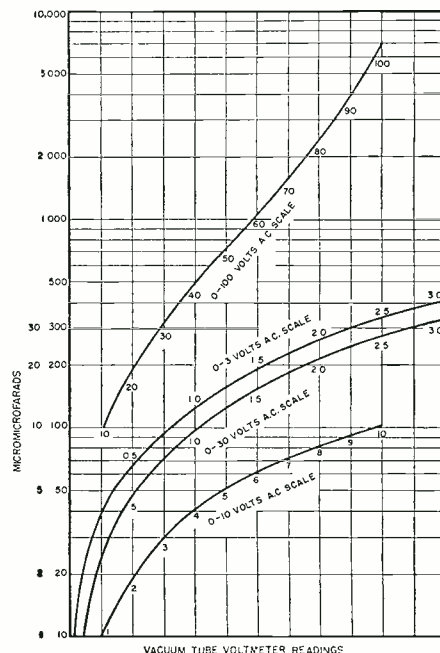

A LOW-PASS FILTER

Internal view of aluminum filter box showing arrangement of parts. The 42 $\mu\text{fd.}$ capacitors are at each end while the 136 $\mu\text{fd.}$ capacitors are visible in middle of box.

FROM STANDARD PARTS

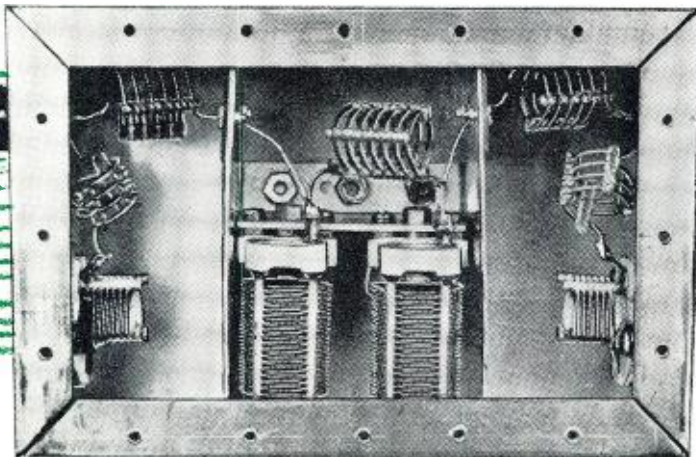

By NEIL A. JOHNSON, W2OLU

TELEVISION, like the automobile, seems to be here to stay. Even the most conservative-minded amateur will have to admit that such a statement rings true. And it makes little difference whether he is an American ham living in the shadow of channel 2; or his British brother amateur trying to work DX from the vicinity of Birmingham; or a Cuban *aficionado* calling CQ from suburban Havana—all are faced with the same problem: TVI.

Most hams are well acquainted with the need for adequate filtering and complete shielding of any ham rig that is to escape the stigma of TVI. This done, it has become the accepted practice to feed the output of the transmitter into a coaxial line and then into a low-pass filter of some sort, before proceeding to the antenna tuner and/or antenna.

With commercial versions of suitable low-pass filters averaging close to 25 dollars, the average ham is inclined to "put it off." Such an attitude can hardly be expected to enhance the prestige of amateur radio, either for the individual concerned, or for the amateur radio body as a whole. On the other hand, many excellent "how-to-build-it" articles have appeared in radio literature over the past few years, describing the construction of relatively inexpensive low-pass type filters suitable for amateur service.

Unfortunately, most of these items conclude with "instructions for adjustment," in which the amateur operator is told how to tune up his filter prior to installation. Most of us will admit that a grid-dip oscillator is a handy tool to have around the shack; however, it is equally true that most hams do not possess such an instrument. This brings us right back to where

Details on a unit especially designed for amateur service. High attenuation through use of M-derived end sections gives an average of 60 db attenuation on channels 2-6. Input to final is 500 watts and impedance is 50 ohms.

we started: where to get the money to buy a commercially-produced filter; or else, where to get the dollars to buy a grid-dip meter?

It would certainly be a very nice state of affairs if the average ham could go into his parts supply distribu-

tor and order a fixed capacitor of, say, 136 $\mu\text{fd.}$, plus or minus 2%—or, in a similar manner, a fixed inductor of 0.196 microhenry within 5%. This would be an ideal state. Of course, it can be done, if you are able to pay skyscraper prices for customized components; this in addition to a waiting period of some six weeks. Dollarwise, this would end up costing more than the commercially-packaged filter units.

The writer had mulled over this possibility many times while passing a few otherwise dull moments, waiting for the Stamford local to pull out of Grand Central terminal; How about customized components (and at regular prices) in order that an average ham might build up his own low-pass filter? Most of the old-timers can recall the plate-pulling technique that was used by hams of twenty-five years ago for modifying the capacity of *Pilot* midget variable capacitors. Hence, why not "pull" plates from a standard line of capacitors, which should be widely available, and thus arrive at our "customized" fixed capacitors?

Looking around for such a component, we hit upon the idea of utilizing the APC type of midget capacitor. Several representative types, obtained both in the regular and in the surplus markets, were tried out. With respect to the type which uses soldered plates, upon measuring over a dozen capacitors of different capacities and makes, it was determined that the average capacity shown by any two adjacent

Complete schematic diagram of the low-pass filter. All coils must be considered as inductors whose value will change if lead lengths are varied. All of the capacitors listed are used with plates fully meshed. All coils should be cut with leads $\frac{1}{2}$ " longer than listed. After installing, the "extra" length may be cut off or doubled back and soldered. Impedance is 50 ohms.

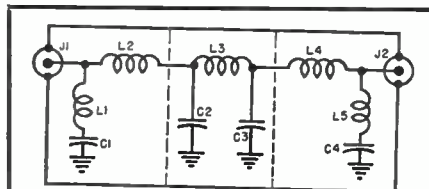

C₁, C₅—50 $\mu\text{fd.}$ APC type, 14 plates. Remove 1 stator and 1 rotor plate

C₂, C₃—140 $\mu\text{fd.}$ APC type, 36 plates. Remove last plate. (whether stator or rotor, remove the last plate only)

L₁, L₅—2 $\mu\text{hy.}$, 3 $\frac{1}{2}$ t. with $\frac{1}{2}$ " leads at each end of coil

L₂, L₄—3 $\mu\text{hy.}$, 5 $\frac{1}{2}$ t. with $\frac{1}{2}$ " leads at each end of coil

L₃—38 $\mu\text{hy.}$, 7 t. with $\frac{1}{2}$ " leads at each end of coil

All coils made from sections of B & W #3002 "Miniductor" stock.

J₁, J₂—Mica-filled receptacle (Amphenol 831R or equiv.)

Chassis—Aluminum chassis, 2" x 4" x 6" (Bud AC 431)

plates was very close to 3.87 μfd . Thus, an APC-type capacitor of 14 plates is rated at 50 μfd : its capacity can be readily computed by the equation: Capacity (in μfd .) = 3.87 (N-1). If the number of plates is 14, N-1 becomes 13, which multiplied by 3.87 gives us quite close to the rated 50 μfd . We also learned about this time that it was easily possible to remove two plates, one rotor and one stator, from a standard 50 μfd . APC capacitor and obtain close to 42 μfd , which value is generally used in the end sections of 50-ohm low-pass filters. Likewise, we determined that by pulling just one plate from a 140 μfd . APC capacitor, we arrived at a value very close to 136 μfd . All of these values were carefully checked, using a *General Radio* 740-B capacitance bridge. The required plates can be easily removed by gently flexing them with a pair of long-nose pliers, taking care not to disturb the spacing of adjacent plates. Generally speaking these capacitors are far superior to the receiving-type ceramic units sometimes used in economy filters of this sort. With a higher breakdown voltage, the ham need not worry about having a perfectly-matched line, as long as the standing wave ratio is within reasonable limits, since these capacitors are generally rated at 750 volts a.c. test at 60 cycles. This is far higher than will be found in any 50-ohm coaxial line, working at amateur powers.

With these capacitance values easily obtainable, a search was begun for suitable inductors, whose values, once obtained, could be easily duplicated by any experimenter who is willing to follow mechanical directions. Suffice it to say that several evenings later, after many different coils had been wound, and most had bitten the dust, we settled for the *B & W* "Miniductor" series, coil number 3002.

Complete coil specifications will be found in the parts list accompanying the circuit diagram. These inductance values were first obtained by using an *L*-bridge to obtain the various values listed. However, the lead length is important at the frequencies involved, and it was found necessary to prune the coils slightly once they were installed in the shield box. This was done by the cut-and-try method, using a *Heathkit* grid-dip oscillator for the actual frequency checking of the various sections. However, this procedure need not be repeated, as long as the builder follows the mechanical layout, and wiring instructions, *without any variations*. It should be realized at the beginning of a project such as this, that any change in the physical location will invariably have a noticeable effect upon the performance of the filter. This is particularly true of the end sections which resonate, including the chassis return path, at 55 mc.

If all parts are bought at prevailing prices, the total filter will run about eight dollars. If surplus APC type capacitors are available, the cost will be cut in half, or possibly less. Ours

cost \$3.75, buying all parts from scratch. We have checked the APC capacitors made by several different manufacturers, such as *Oak*, *Sickles*, and others; and with the standard APC spacing of .015 inch, we found the capacity values very close to those stated. However, a word of caution is in order: since we intended to use the capacitors at very high frequencies (v.h.f.) we decided at the outset to employ only those which used soldered-plate construction. We have not checked into the use of capacitors using staked aluminum plates; and their use cannot be recommended from personal experience.

In assembling this unit, the 42 μfd . capacitors are installed at each end of the aluminum filter box with the 135 μfd . units in the center. The series .2 μhy . coil from the coaxial connector may be soldered to the front or rear of the 42 μfd . APC stator post, whichever is closer or gives the shorter connections. The shields, spaced about 2" in from the end of the chassis, need not be exactly square but they should be close fitting. Where conductors pass through the shield, insulation is provided by drilling a $\frac{1}{4}$ " hole through the shield, then insulating with a sheet of poly or *Lucite* which has a $\frac{1}{16}$ " hole for passage of the wire. The polystyrene sheet may be held on the shield by self-tapping screws or held in place with *Duco* cement.

The two 136 μfd . center capacitors are bracket-mounted to the chassis. They may be mounted either head-end to or tail-end to the center coil which ever results in a shorter path to the chassis. The center section resonates close to 29 mc. and is not quite so critical as the end sections, which actually resonate at 55 mc. With an effective filter of this sort, care must be taken to prevent leakage. This is afforded by screwing the cover plate on tightly with 4-40 screws every inch along the edge of the chassis.

The diagonal placement of the coaxial socket connector results in smooth fitting of the coax connector to the chassis box which has an interior fold-over adjacent to the connector. The 2"

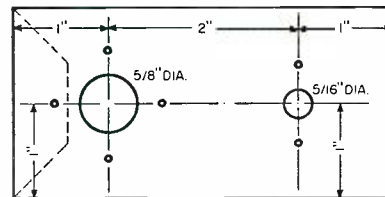

Details on mounting coaxial socket and 42 μfd . capacitors on ends of the chassis. Coaxial socket must be mounted diagonally as shown in order not to interfere with chassis fold (shown dotted). If a slightly larger chassis is used, keep the coax receptacle and 42 μfd . unit separated by the same distance as shown, i.e., 2 inches.

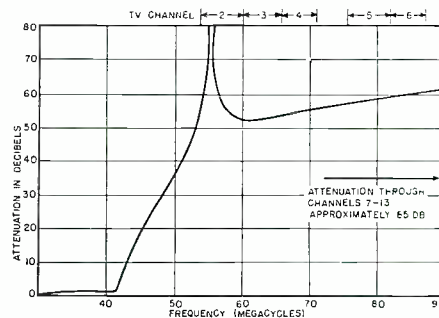

Performance of the low-pass filter on channels 2 through 6. See discussion in text.

separation and mounting of the APC end section capacitor is apparent in the photographs. The cover plate was made $\frac{1}{2}$ " wider than the chassis to enable it to be securely mounted to the exterior of the transmitter housing with 4 machine screws, one at each corner. Although not shown in the photographs, sixteen metal screws are used to fasten the cover plate to the chassis.

In order to give the filter a fair trial, we looked for a suitable dummy load with non-reactive characteristics. Our first try involved using a surplus Loran test unit, which had 3 "non-inductive" resistors, of 150 ohms each, in parallel. Whatever the ratings might have been at 1.9 mc., we found considerable reactance present at 14 mc. Finally we settled for a bank of carbofilm non-inductive resistors, com-

(Continued on page 149)

★
Top view of unit showing diagonal placement of coaxial socket connector. See text.
★

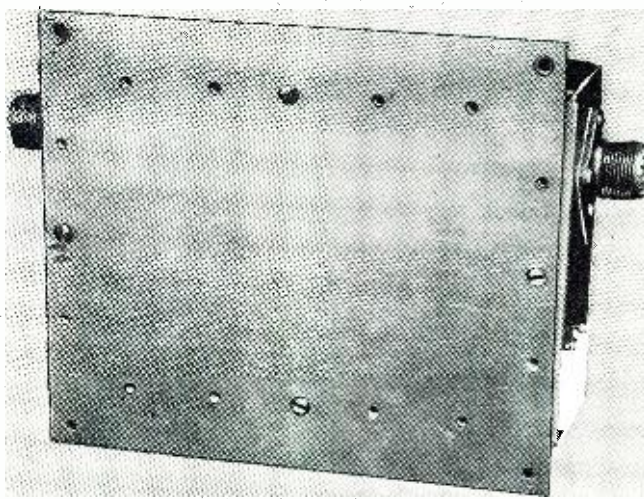

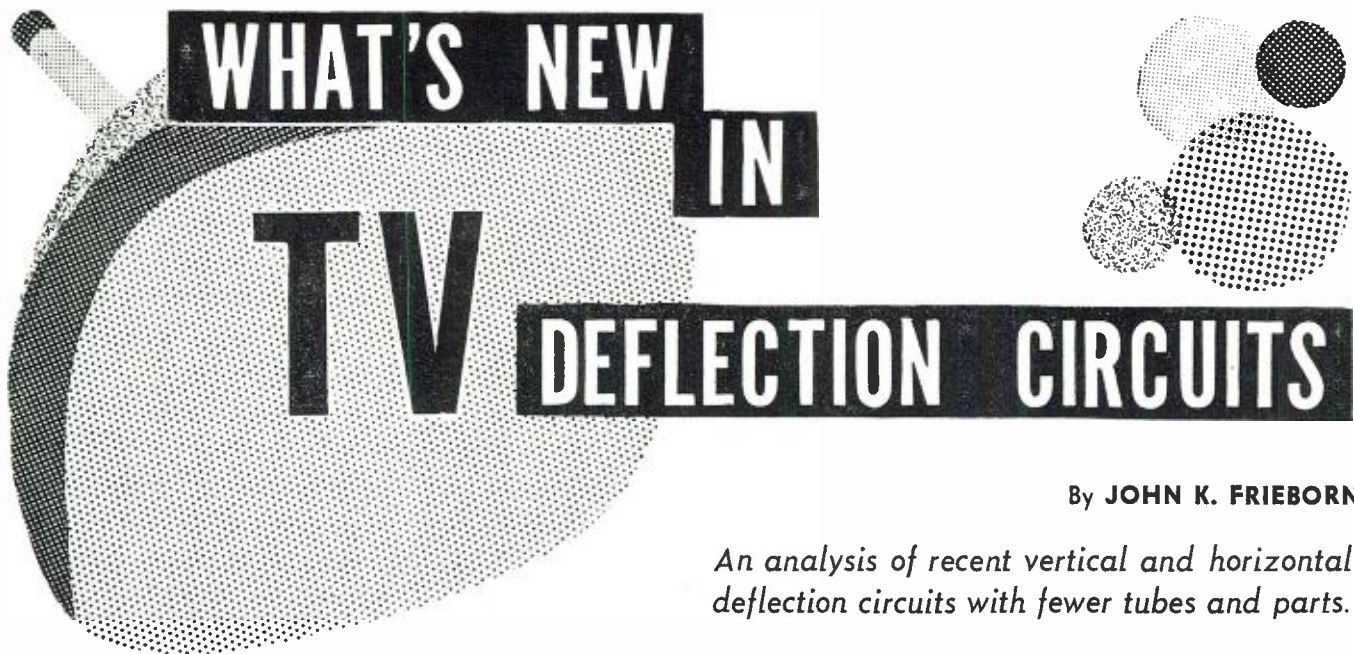

WHAT'S NEW IN TV DEFLECTION CIRCUITS

By JOHN K. FRIEBORN

An analysis of recent vertical and horizontal deflection circuits with fewer tubes and parts.

HOW do engineers dream up the circuits used in television receivers? Usually, they don't exactly dream them up, they develop them from older circuits. The easiest way to understand the vertical and horizontal deflection circuits used in today's sets is to trace their development.

The standard circuits, the ones usually described in books and magazines, are the grid-coupled and cathode-coupled multivibrators, the one- and two-tube blocking oscillators, and the type used with the *RCA Victor* "synchronlock" circuit, in which the saw-tooth discharge tube is triggered by the shaped output of a continuously-operating sine-wave oscillator. Modifications of the grid-coupled multivibrator and the sine-wave triggered circuit are particularly suitable for the vertical and horizontal deflection circuits, respectively.

For vertical deflection in a television receiver, the oscillator should allow accurate synchronization, field by field, with the transmitted sync pulses. Extreme frequency stability is not necessary and, in fact, may be undesirable. It is not necessary because the vertical oscillator is not particularly susceptible to the effects of noise; most circuits to separate the vertical sync pulses from the horizontal will also eliminate most of the noise. Extreme stability is undesirable because the vertical oscillator sometimes may be required to change phase considerably within a few cycles. This happens whenever the video signal is taken from a new source which is not synchronized with the previous one, as when the receiver is switched to a different channel or during a station break in a network broadcast.

On the basis of speed and accuracy of synchronization, the choice for a vertical oscillator would be between the multivibrators and the blocking oscillators. In these circuits, a cycle can be ended whenever a large enough positive pulse is applied to the grid of

the discharge tube to cause it to conduct; therefore, the phase can be changed by a large amount from one cycle to the next. The amplitude of the synchronizing pulse which is required depends upon the tube characteristics, the d.c. voltages applied, the values of other components, and the time the pulse arrives.

Different engineers have different opinions regarding the relative merits of multivibrators and blocking oscillators, but both types of circuit seem to be quite satisfactory for television reception. On the other hand, a sine-wave triggered oscillator is much too stable for vertical deflection.

The most important development in vertical circuits has been their simplification. The largest single step which can be taken in that direction is the saving of a tube or transformer. This can be accomplished by combining the oscillator and amplifier.

In the standard grid-coupled multivibrator, one tube normally is called the discharge tube. The other tube may be called the coupling tube, since it couples a signal from the plate of the discharge tube back to its grid in the proper phase to produce oscillation. Fig. 1 shows a typical grid-coupled multivibrator and amplifier circuit, that used in the *G-E Model 21T4*. C_{306} and C_{307} are the saw-tooth condensers, which are charged through R_{229} and R_{308} and discharged through V_{0b} , the discharge tube. V_{0a} is the coupling tube. R_{308} , which determines the rate of charging of the saw-tooth condensers, is the height control. R_{305} , the frequency control, determines the time constant of the discharge of C_{255} and, in turn, determines the length of time V_{0b} remains cut off during each cycle. V_{10} is the amplifier tube and R_{231} the usual linearity control.

Waveforms at the grid and plate of the coupling tube and at the grid and plate of the amplifier tube are of the same phase, but somewhat different shapes and considerably different am-

plitudes. Therefore, it ought to be possible to use the amplifier as a coupling tube, feeding a signal from its plate back to the grid of the discharge tube, provided that the coupling is made through a suitable network to reduce the amplitude of the signal and change its waveshape. Such a combination grid-coupled multivibrator and amplifier is now used by many manufacturers. The various designs differ from each other mainly in the type of network used to reduce and shape the discharge tube triggering pulse and in the point in the circuit to which synchronizing pulses are applied.

Conventional grid-coupled multivibrators usually have negative sync pulses applied to the grid of the coupling tube. In the equivalent combination circuit, negative sync pulses are applied to the grid of the combination amplifier and coupling tube. *Zenith* 1953 and 1954 receivers using the "L" series chassis are typical of those using this arrangement. Fig. 2 shows a schematic diagram of the vertical oscillator and amplifier used in these chassis. In this circuit, V_{10b} is the discharge tube and V_{12} is the combination coupling tube and amplifier. C_{46} is the saw-tooth condenser, which is charged through the size control, R_{259} , and discharged through V_{10b} . R_{05} is the peaking resistor, across which the negative pulses of the trapezoidal wave appear. Negative sync pulses are applied through C_{45} and C_{50} to the grid of the amplifier-coupling tube and positive pulses are fed back to the grid of the discharge tube through the dividing and shaping network consisting of C_{45} , C_{48} , R_{07} , R_{23} , C_{85} , R_{04} , and C_{17} .

An unusual feature of this circuit is the hold control in the cathode circuit instead of the grid circuit of the discharge tube. The action of this circuit is similar to that of the conventional one, except that here condenser C_{67} is charged by both plate and grid current, instead of grid current alone. Increasing the value of the resistor, R_{06} , further

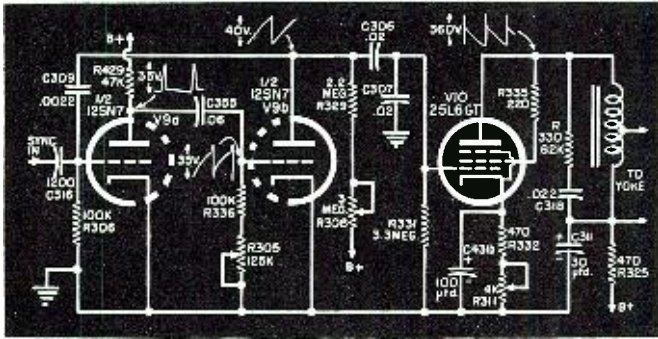
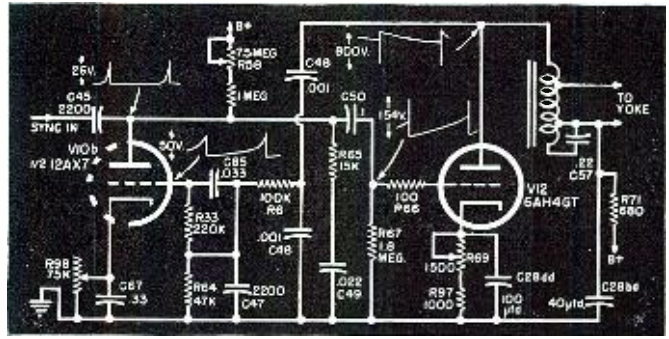

Fig. 1. Vertical deflection circuit used in the G-E Model 21T4.



EVEN though one can fly the Atlantic in less than a day, a world of difference exists between radio and TV repair in America and England. For over a year and a half now, I have been working as a TV bench mechanic, in and near London. Since our last home was in New York, I am able to compare and contrast radio and TV problems in two of the world's largest cities.

Certain basic facts should be understood:

1. All radio and TV transmitting stations now broadcasting in England are government operated. (Some privately owned stations are now under construction.) The only commercial broadcasts received are by radio, and these come from Radio Luxembourg.

2. While the British Broadcasting Corporation has so far built and has in operation five TV transmitters, all of these stations carry the same programs most of the time. They use different frequencies to avoid interfering with one another. Thus, in any one area, all TV sets are always tuned to a *single channel*. In fact, the only provision for tuning the sets is on the back of the chassis, and is usually not accessible without removing the back cover. No bandswitches; no tuner troubles.

3. Since only one station is regularly received, aerials (antennas) are installed so as to get best reception of that one station. Aerials are cut to the exact frequency; ghosts are a minor problem!

4. The standards adopted for transmission are different than those of the U.S. and in themselves, simplify the problems of TV servicing. The frequencies used fall within our channels 2 to 7, and are relatively solid and unaffected by the vagaries of higher frequencies. Whereas the U.S. uses 525 lines, in England only 405 lines are used. This results in a horizontal-oscillator frequency of 10,125 cps and also in a frame frequency of 25 per second. Due to the smaller number of lines, a narrower bandwidth is possible. In fact, the sound carrier is placed only 3.5 megacycles away from video—so the average set produces, at best, about 3 megacycles definition. Narrow bandwidth leads to fewer problems of staggering i.f. stages, fewer stages of i.f., and little difficulty with alignment.

Vertical polarization is used for the transmitted signal resulting in dipoles pointed skywards, less airplane flutter, and less need for directional aerials. With only one channel anyway, there are no headaches such as we know so well in the States, trying to satisfy customers desiring reception from several directions. There is also no problem of re-orientations due to wind turning the aerial.

Sound is transmitted in the amplitude-modulated form. No discriminators, no ratio detectors, no intercarrier. I find that most English technicians have had no experience with FM.

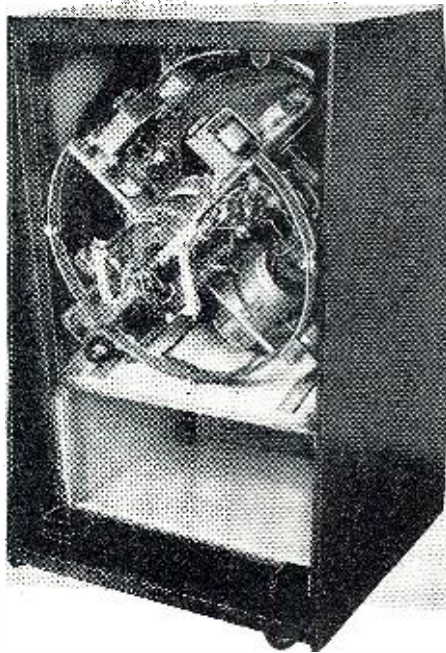

TV REPAIR

By
JOHN D. BURKE



A radial TV receiver chassis manufactured by Murphy Radio Ltd. is shown as it sits in its cabinet on the left. This is a fairly popular English receiver and predates our vertical chassis sets.

A Yankee TV service technician working in England makes some interesting comments on TV servicing over there.

Most British TV sets have very simple sync circuits, and very often the horizontal amplifier tube also serves as the horizontal oscillator as well. The various types of more elaborate circuits, so necessary and so commonly used in the U.S., and the tricky noise clipping devices are unknown and unnecessary in England. This is due to the positive modulation used with video transmission. The sync pulses are below the carrier level and are very little affected by noise pulses.

No automatic gain control is found in any sets, except a few very recently sold, because with one station there is constant signal strength; no need for a.g.c.

As for the sale of radios and TV receivers, it is a fact that in all this time I have heard of no case where a TV or radio was sold at less than list price! Only one form of discount selling has come to my attention. Whereas some dealers give only the 90-day free service, together with manufacturer's parts warranty, other dealers do give one year's free service, aside from parts and tubes, which carry only the manufacturer's warranty. Actually, that amounts to a discount, but it is not advertised as such. The manufacturers are quick to take away franchises if their products are sold below retail.

Most service shops work six days from 9 a.m. to 6 p.m., with a half-day off on Thursday. Some shops only work five days.

It is necessary to digress for a moment to the question of BBC programs. I found it rather a shock, after New York, to become used to the BBC's leisurely way of doing things.

If anyone wants to test a television set before 10 a.m., he must use a pattern generator for the BBC does not come on the air until 10. (Radio programs start at 6:30 a.m.) Then comes a two-hour transmission which varies only slightly from day-to-day, week-to-week, month-to-month. This consists of a "demonstration film" which reviews the history of television, gives some samples of programs from the past, and some old news reels. (The latter are changed occasionally.) Interspersed every 15 minutes or so are some test patterns.

Sharply at 12 noon they are gone. Right in the middle of a job, likely as not! We cuss and turn on our pattern generator.

In preparation for the Coronation, the BBC unbent a little and transmitted a test pattern for an additional hour, from 12 to 1 p.m.

At 3:15, the BBC is usually on again, this time with various types of programs—interviews, films, sports, an air show, etc. They may or may not stay on continuously thereafter. Each day it is necessary to consult the official publication "*Radio Times*," to plan work, particularly in relation to delivery of new sets, installation and try-out of aerials, and return of repaired sets.

In England, most TV repair jobs go to the shop. When the set is removed, the cabinet goes along with it. There are good reasons for these procedures.

While you may think there are many small tube types in use in the U.S., you should see what a variety has been installed in English sets. It is impossible to carry a small suitcase-type tube assortment and do most home calls as I have done in New York. Also,

IN ENGLAND

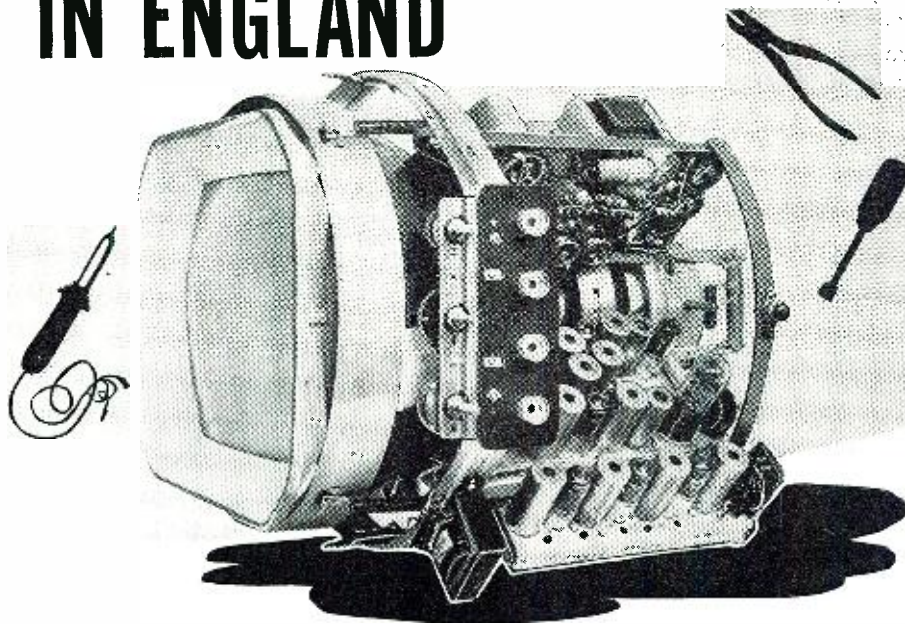

in England, quite often the man who goes on the service call is either completely nontechnical—such as a truck-driver, or he is a repairman qualified to do only minimal repair jobs. It is quite awkward to get the average chassis out of its cabinet. Particular attention is given to covering the back, the bottom, and any metal which might be touched by user or by children, for power-line supplies average 230 volts.

Some other reasons why sets are taken to the shop for service are that pulling out tubes is usually more difficult in English sets than in American sets—some types are harder to get out than loctals are. The hours of transmission being limited, service in the home would require carrying a portable pattern generator for those times when the BBC is off. Also, there is no TV repair service after 6 p.m. As we know, in the U.S. much work is done in the evening, and this accounts for a big part of work done in people's homes. In addition, there is no standardization of power outlets. One may find any one of 8 or 10 different shapes of wall outlets. This makes it difficult to use test equipment in the home.

Charges and Wages

On the one hand, wages for service technicians are very low compared to the U.S., yet, one can live quite comfortably on the wages paid in our trade. TV service technicians earn more than bus drivers, railroad engineers, and even many factory workers. But, whenever a TV set goes to the shop for repair, if it is not under guarantee, the minimum labor charge (including pickup and delivery) almost equals a *full day's pay* for the bench mechanic. This is true for all jobs, simple or difficult. The very difficult have added labor charges, but the amount goes up gradually.

Now, to appreciate this apparently outrageous system of charges, or rather, get the picture more clearly in mind, it is necessary to relate TV labor charges to the price of tubes and parts. The average small tube (called a "valve") costs the public about 1 pound (including a heavy purchase

tax). This is approximately equal to \$2.80. A horizontal output transformer costs from 2 to 4 pounds. A whole TV 12-inch table model costs more than 60 pounds. A picture tube costs from 14 to 20 pounds.

So, if the minimum labor charge is 30 shillings (that is, one and one-half pounds), that charge is reasonable. The service technician is able to live on a wage of 30 shillings a day. (Some earn about 2 pounds.)

The point is, such things as TV are still very expensive to buy and to operate in England. Other things are much cheaper proportionately than in the U.S. This high cost has slowed down the growth of television.

From the repair point of view, it makes for a completely different relationship between the customers and the shops, and between employers and employees. While I have heard a few arguments over TV repairs, I have not heard anything like the arguments which were going on back home when I left. From the press accounts I read, you are still having a mad time. In any case, I have enjoyed the freedom from night work; and the only "arguments" I have had have been with the sets. For the sets are quite different from American sets, the schematics and service information are different, and I never dreamed how many varieties of vacuum tubes there are until I came to England. —30—

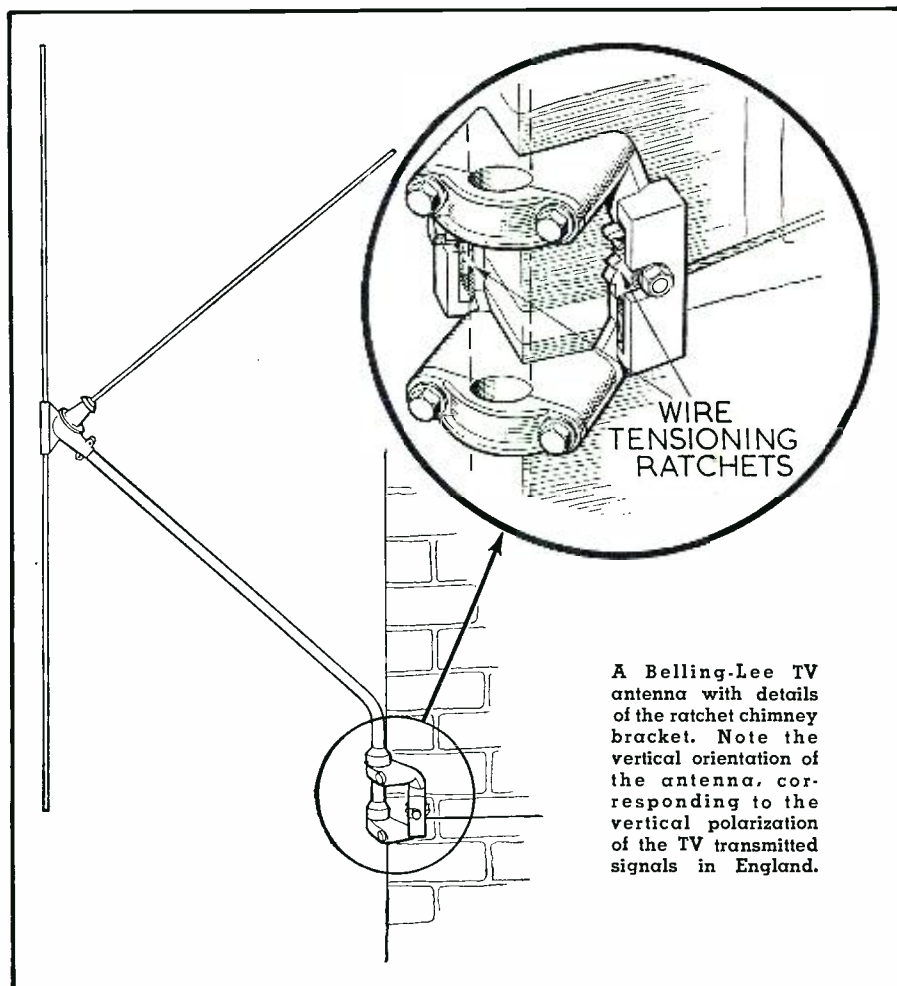

A Belling-Lee TV antenna with details of the ratchet chimney bracket. Note the vertical orientation of the antenna, corresponding to the vertical polarization of the TV transmitted signals in England.

THE MOTOROLA 19" COLOR TV RECEIVER

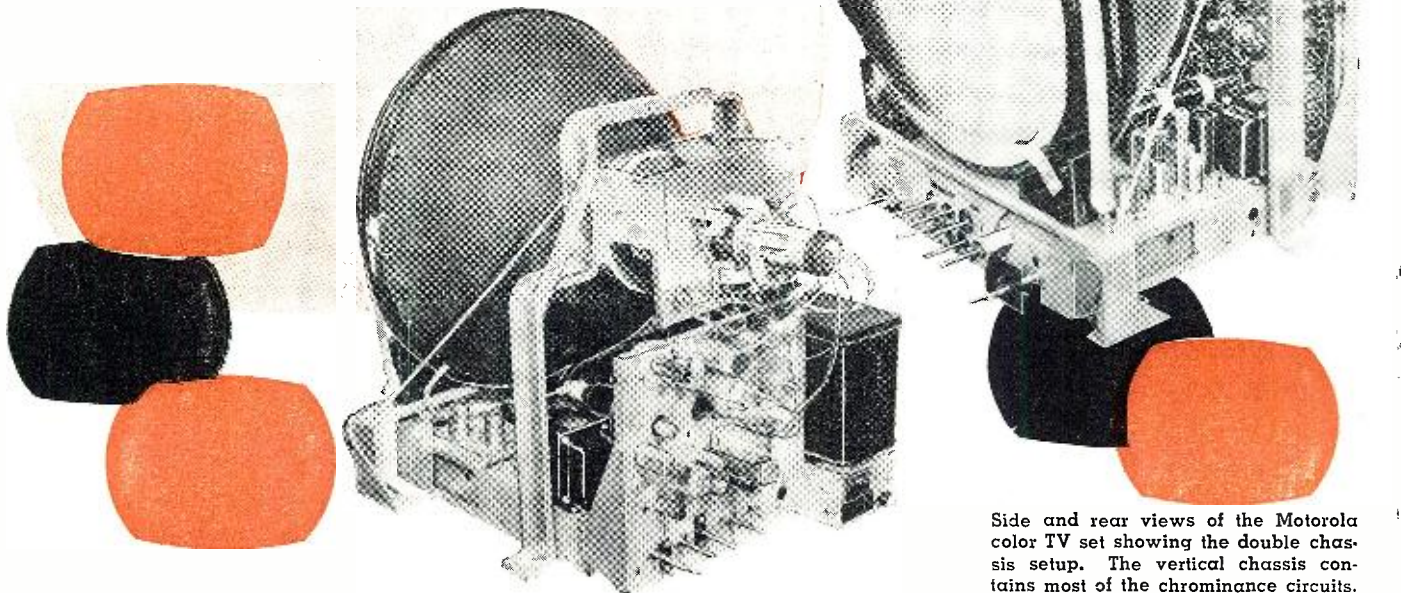

Side and rear views of the Motorola color TV set showing the double chassis setup. The vertical chassis contains most of the chrominance circuits.

By M. S. KAY

Part I. First complete analysis for service technicians of the first 19-inch color TV receiver widely available.

ONE of the first color television receivers to appear on the market using the 19-inch CBS color tube is the *Motorola*. The receiver is built around 29 circuit tubes, a 19VP22 19-inch tricolor picture tube, three germanium diodes, and three selenium rectifiers. Power consumption of the total receiver is a very moderate 375 watts.

The tremendous progress which commercial color television has made in less than one year after its official adoption is best revealed by the fact that relatively so few tubes are required to present a full color picture. When it is recalled that the first color receiver, the *RCA CT-100*, had 36 tubes, 3 germanium diodes, and 2 selenium rectifiers (plus a 15GP22 color tube) only 9 months before, we realize that a 20 per-cent reduction in so short a time is a remarkable feat.

A block diagram of the *Motorola* receiver is shown in Fig. 1. Of the r.f. and video i.f. stages, little need be added to what has already been said in prior articles appearing in this magazine. Actually, *Motorola* is using the same circuits here that they ordinarily use in their black-and-white receivers with some minor modifications to encompass the wider composite color signal. Also, sound take-off is accomplished at the plate of the 3rd video i.f. rather than beyond the second detector. This enables the circuit design-

ers to impose additional attenuation on the sound carrier prior to the video detector in order to minimize the appearance of the 920 kc. signal obtained when the sound and color subcarrier signals beat with each other.

Of particular interest here are the circuits which are found beyond the video detector. The schematic diagram of Fig. 2 reveals two video amplifiers which resemble monochrome video amplifiers except for the lack of special peaking coils in the output of the first video stage. However, it will be noted that the principal load resistor for V_{6A} is only 820 ohms (R_{62}), a value low enough to maintain the amplifier response up to 4 mc. In the output of the 2nd video amplifier there is compensation and hence higher value load resistors are permissible.

Both the color and monochrome components of the composite signal remain together through both video amplifiers. Separation then takes place at the plate of the 2nd video amplifier. The brightness component is led off to a separate brightness output amplifier (V_{20} , a 12BY7) via R_{68} and L_{16} , a .6-microsecond delay line. (The reduction in delay time from the usual 1 microsecond to .6 microsecond will be discussed presently). At the same time, the chrominance portion of the signal appears across R_{67A} and R_{66} , and is applied to a 12BY7 bandpass amplifier, V_8 . Just how much chrominance signal

reaches V_8 is governed by the setting of R_{67A} . This potentiometer, the contrast control, acts in conjunction with R_{67B} in the cathode leg of the brightness output amplifier. Both are mechanically ganged, permitting the simultaneous adjustment of the chrominance and monochrome signal levels. A separate control is available at a subsequent point in the color system to permit independent adjustment of the color intensity of the picture.

Brightness Signal. The brightness or monochrome signal is amplified by V_{20} and then passed through a 3.58-mc. filter before being applied to all three cathodes of the picture tube. The 3.58-mc. trap serves to attenuate any color sidebands that may be present at this point. The trap also tends to limit the bandpass of this circuit to a value somewhere between 3 and 3.2 mc. Hence, in spite of the fact that monochrome signals up to 4.2 mc. are initially sent from the station, only those frequencies up to 3.2 mc. are actually effective in developing the picture.

The monochrome signal at the picture tube cathode has negative polarity, a condition that is required for the proper combination of the brightness and chrominance components of the color signal. Actually, the matrixing of the two portions of the color signal occurs within the picture tube itself rather than in a separate resistive network.

Bandpass Amplifier. The color signal, once it leaves the 2nd video amplifier, travels to V_8 . A potentiometer in the cathode leg of this tube varies the gain of this stage and since only the

color portion of the signal is thus affected, the control is labeled on the diagram as the chroma control. For the consumer, this knob is labeled "color intensity," this being considered more descriptive of its action. Maximum gain occurs when the knob is fully clockwise so that the 10,000-ohm resistor is completely out of the circuit.

The color burst signal also passes through the bandpass amplifier. To insure that sufficient burst voltage is available at all settings of the chroma control, a special positive pulse is fed into the grid circuit of V_8 , the bandpass amplifier. This pulse is obtained from the horizontal output transformer and is so timed that it arrives at the same instant as the color burst. The pulse decreases the bias on the tube, causing it to furnish more plate current during this interval. In this way, a color burst signal is obtained which, at every setting of the chroma control, is strong enough to adequately drive the color a.f.c. network.

A 1N60 germanium diode is connected between the chroma control and the grid circuit to maintain the amplitude of the burst signal at its most efficient level. Here is how it does this. The cathode end of the 1N60 is connected to the top end of the chroma control and hence is subject to whatever positive potential exists at this point. Let us say this is +5 volts. The other end of the 1N60 connects to R_{102} , a 10,000-ohm resistor in the grid circuit of V_8 . This same resistor develops the positive boosting pulse. If the pulse raises the voltage across R_{102} above +5 volts, the 1N60 conducts and serves to maintain the voltage across R_{102} at the same level as the voltage across the chroma control. When the chroma control is completely in the circuit, V_8 grid bias is greater and more positive boost voltage is received for the arriving color burst. On the other hand, when the chroma control is completely out of the circuit, V_8 is operating at full gain. At this point no intensifying pulse is needed and none actually reaches it because the 1N60 tends to maintain the voltage across R_{102} at zero volts.

Burst Amplifier. The output of the bandpass amplifier is applied to two points: a bandpass cathode follower and a burst amplifier. Considering the latter first, the signal is brought to the amplifier by way of L_{201} . L_{201} and C_{206} form a 3.58-mc. tuned step-up network in which the applied burst voltage is actually fed to the grid of V_{23A} in greater amplitude than it is applied. Adjustment of C_{206} will vary the phase of the burst which the burst amplifier receives. When the circuit is precisely tuned to 3.58 mc., the signal developed by the circuit will have the same phase as that of the incoming burst signal. If C_{206} is detuned, the signal developed by the resonant circuit will either lag or lead the incoming burst signal. Since the color a.f.c. stage receives the burst from this amplifier, it will shift the phase of the generated 3.58-mc. subcarrier to follow suit. This, in

turn, will alter the colors produced on the screen. Because of this action, the shaft of C_{206} is extended to the front panel and labeled "color shading control." Its proper setting is determined by the set user according to the color of some familiar object.

The burst amplifier stage shown in Fig. 2 appears to have no "B+" screen voltage. Instead, the grid is connected to a special winding on the horizontal output transformer and from this point it receives periodic positive pulses. These pulses are timed to arrive with the color bursts and possess sufficient amplitude to drive the tube into conduction. R_{201} , R_{202} , and C_{201} serve as a phase shifting and shaping network to insure that only the color burst passes through the stage. The action of the network is illustrated in Fig. 3.

Color Sync Section

The entire color sync section, consisting of V_{23A} , V_{21B} , V_{23A} , V_{23B} and V_{22B} is sufficiently similar to the color sync sections discussed in previous issues of RADIO & TELEVISION NEWS not to warrant any additional explanation here. Of interest, however, is the phase shifting network, T_{201} , which provides two 3.58-mc. signals to the color demodulators which are 90° out-of-phase with each other.

The network is shown by itself in Fig. 4A. The plate of the buffer connects to the top of L_{210} and it is from this point that the R-Y demodulator obtains its 3.58-mc. signal. On a vector

diagram of this network, then, we can use the R-Y vector as our starting point. See Fig. 4B. Let us call the voltage across L_{210} , E_1 . This same voltage also appears across the series combination of C_{212} and C_{213} and divides across them in inverse ratio to their capacitance. Of interest is the voltage across C_{213} and this is shown as E_2 in Fig. 4B. E_2 is also the voltage which is applied across the series combination of C_{211} and L_{200} . Since this combination is resonant to 3.58-mc., whatever current flows through C_{211} and L_{200} will be in phase with E_2 . This current is labeled I_2 in Fig. 4B. The voltage drop produced across L_{200} by I_2 leads the current by 90°. This is E_3 and is the 3.58-mc. voltage which the B-Y demodulator receives.

Of interest to the service technician is the manner in which this circuit would be adjusted. A v.t.v.m. is connected to the cathode of V_{23A} , the R-Y demodulator by means of a chassis test point through a 100,000-ohm isolating resistor. The ground terminal of the meter goes to the receiver chassis. With the receiver in operation, a d.c. voltage will appear at the cathode of V_{23A} because the diode is detecting the applied 3.58-mc. oscillations. This voltage will be somewhere in the neighborhood of 25 volts. The slug in L_{210} is now adjusted until the v.t.v.m. reading is maximum.

The next step is to adjust L_{200} and a moment's reflection will reveal that since C_{211} and L_{200} form a series resonant circuit, they will impose maxi-

Fig. 1. Block diagram of the Motorola 19-inch color TV receiver. The pulse fed to the bandpass and burst amplifiers is obtained from the flyback transformer.

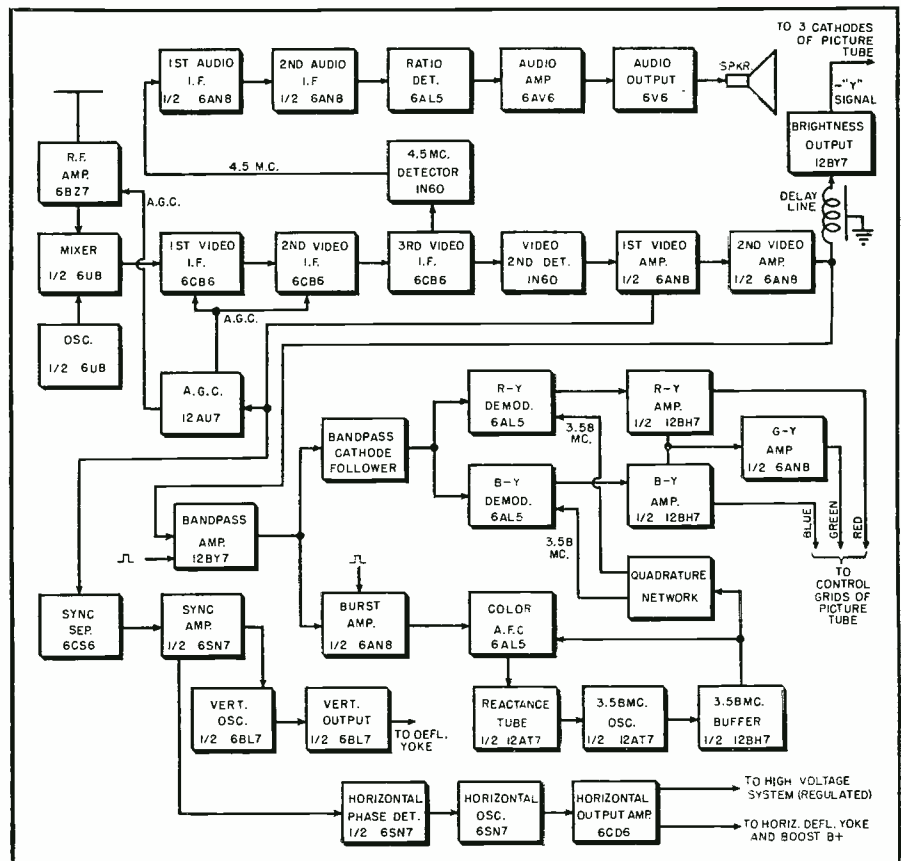
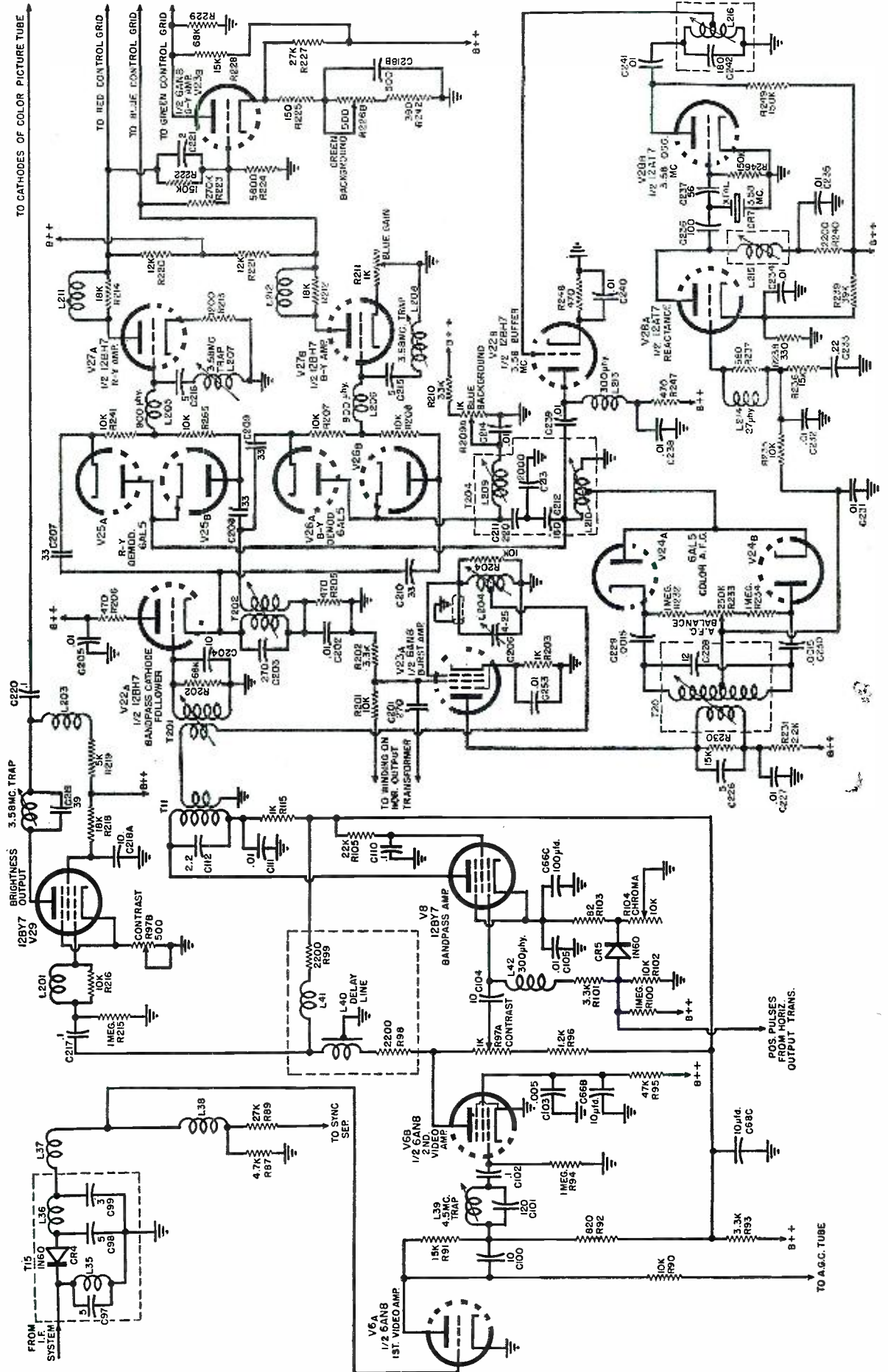

Fig. 2. Schematic diagram of the chrominance circuits of the Motorola receiver.



imum load across the rest of the quadrature network when they are tuned to 3.58-mc. Hence, the slug in L_{200} is rotated until the meter at the cathode of V_{25A} dips. To insure that the alignment is precise, the over-all procedure is repeated several times until no further adjustments are required.

Important, also, to the service technician is the manner in which the entire color oscillator a.f.c. system would be aligned. In black-and-white receivers the only a.f.c. system used is that found in the horizontal deflection section; in color sets we not only have the latter, but the a.f.c. network in the color sync section as well.

First, connect a v.t.v.m. to the cathode of V_{21A} (Fig. 2) using a 100,000-ohm isolation resistor. The meter should read approximately 12 volts of 3.58 mc. oscillator injection. (Short the control grid of V_{23A} to ground to eliminate spurious incoming signals.)

Next, remove the short circuit from the V_{23A} grid and tune in a color signal. Set the color shading control to midrange. Fully retract the slugs of the burst amplifier grid coil, L_{201} , and T_{20} , the coupling transformer to the a.f.c. circuit. Adjust both slugs for maximum v.t.v.m. readings. This insures that both diodes of the a.f.c. network are obtaining the maximum color burst amplitude.

Now, remove the burst signal by grounding L_{201} . Move the v.t.v.m. to the center arm of R_{233} and adjust this potentiometer to give a zero reading on the v.t.v.m.

Remove the short from L_{204} and adjust L_{215} in the plate circuit of the reactance tube to bring the 3.58 mc. oscillator in phase with the incoming burst. This condition is reached when the v.t.v.m. reads 0 volts, indicating that no correction voltage is being developed by the a.f.c. circuit.

Note how the diodes are used to demodulate the 3.58 mc. signal for the meter.

Color Demodulators

This receiver uses balanced diode demodulators which respond to phase differences in the incoming color signal in much the same manner as the diodes in the color sync section. As a matter of fact, both circuits are similar, as the following analysis will reveal. (The discussion will cover only the R-Y demodulator, since the B-Y demodulator is exactly similar to it).

The incoming color sidebands appear across transformer T_{202} and both R-Y diodes receive equal and oppositely-phased portions of this voltage. See Fig. 2. The connection of the two transformer windings is placed at a.c. ground potential by the presence of a .01- μ fd. capacitor (C_{202}).

At the other end of this circuit, a 3.58-mc. subcarrier voltage is applied from the buffer stage, linked to the 3.58-mc. crystal oscillator. If we were to draw a vector diagram depicting the phase relationship in this circuit, it would appear as shown in Fig. 5A. BC,

the voltage across the first winding of T_{202} , represents the color signal applied to V_{25A} , and BD, the voltage across the second winding of T_{202} , is the color signal for V_{25B} . At the same time, the 3.58-mc. subcarrier is present across L_{210} and it assumes the vector position BA.

Tube V_{25A} , then, is subjected to voltages BC and BA, producing a combined voltage which, in Fig. 5A, is labeled "Resultant No. 1." V_{25B} and its circuit produces "Resultant No. 2." In the case shown in Fig. 5A, both resultant voltages are equal and since they develop equal and opposite voltages across their respective load resistors, R_{241} and R_{205} , the net output voltage from the circuit will be zero.

(If the current path through R_{241} and R_{205} appears somewhat obscure, remember that each 33- μ fd. capacitor (C_{207} and C_{208}) charges up whenever V_{25A} and V_{25B} conduct and then the capacitors discharge through the load resistors during each half cycle when the diodes do not conduct.)

Zero output is obtained when the incoming color sideband voltages are 90° out-of-phase (i.e., in quadrature) with the injected 3.58-mc. subcarrier voltage. In the R-Y demodulator this, of course, will happen when the B-Y color sidebands are applied to it. However, for R-Y signals, the phase relationship is other than 90° (or 270°) and output voltages are obtained. See the resultants in Figs. 5B and 5C. These represent the demodulated R-Y color voltages and their sum is transferred to the following R-Y amplifier through a 3.58-mc. trap.

The polarity of the signal voltages which are obtained from these demodulators depends upon two things: the phase of the applied subcarrier signal and the manner in which the incoming signal voltage is fed to the demodulator diodes. Concerning the subcarrier signal, this can be applied to its respective demodulator either

Fig. 3. In order to key the burst gate amplifier on correctly to coincide with the arrival of the color burst, the keying pulse from the flyback transformer must be delayed. Shown below is the phase shift network used and how it performs.

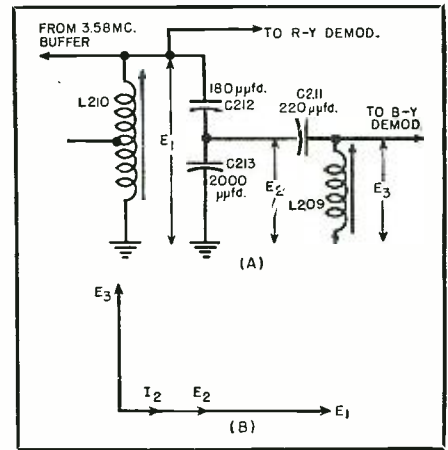
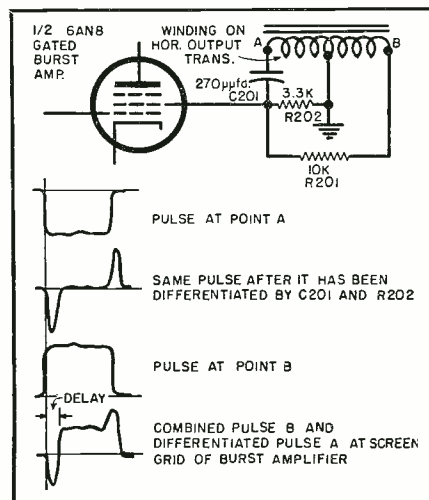

Fig. 4. (A) Simplified version of the quadrature network (T_{201} in Fig. 2) and (B), the phase relationships of the voltages in this network for demodulators.

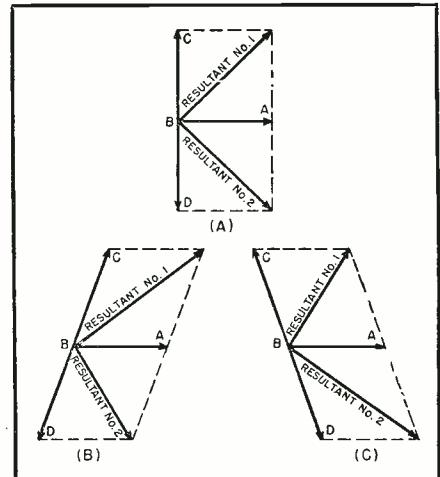

Fig. 5. Vector diagrams illustrating the operation of the diode color demodulators.

possessing the proper phase or 180° from this position. When the latter condition holds, we obtain $-(R-Y)$ from the demodulator instead of R-Y. The same action is true of the B-Y demodulator.

A reversal in signal output polarity will also be obtained if the connections to the diodes are reversed. Thus, if you examine the two demodulators in Fig. 2 you will note that the incoming signal connections to the B-Y demodulator are the reverse of the connections to the R-Y diodes.

In the present receiver, both sets of detectors produce negative output voltages, that is, $-(R-Y)$ and $-(B-Y)$. Reversal to the positive phase is achieved by separate R-Y and B-Y amplifiers after which these two signals are transferred to the control grids of the color picture tube.

For the proper rendition of colors on the screen, it is important that the two diodes comprising each demodulator be balanced as closely as possible. While the circuit is not critical and small circuit unbalances due to parts tolerances will not noticeably affect the color reproduction, still any appreciable unbalance will have a very marked effect. (To be continued)

Certified RECORD REVUE

By BERT WHYTE

THE tumult and the shouting have died away, the New York Audio Fair has come and gone, and here is the report on what was new, novel and nifty at said Fair. Publication dates being what they are, this is a bit late. However, since the majority of the equipment viewed at the Fair won't be on your dealer's shelves by the time you read this, this report can still be timely. If you caught a slight innuendo in the last sentence, you're right. I may be all wet, but I still do not subscribe to the idea of bringing out items of equipment that get people all fired up, and then letting them hang while various "bugs" are worked out and the item is put into production. Hi-fi manufacturers are notorious for this practice and many a good product has been "killed" by this procrastination. No one contests the validity of the theorem of "let's get a reaction from the public," if the manufacturer states that his product is merely a prototype and a long way from actual production. Believe it or not, I know of at least two items which were "hot stuff" at the 1953 Fair, which are still not generally available! Naturally, no manufacturer deliberately causes these situations. It does seem, however, that a company should have enough faith in the product it is offering to the public, to anticipate a certain demand, and if actual units are not stockpiled, at least be prudent enough to be geared for fast production. 'Nuff said about errant manufacturers.

In my report on last year's Fair I had a lot to say about the really incredible noise issuing from most exhibits and the overblown boomy bass which characterized most of the speakers that were shown. Since I have just gone through the experience of "manning" the RADIO & TELEVISION NEWS exhibit for four straight days, I would like to retract last year's statement about noise and modify my views on the boomy bass. Not only do I apologize to those whom I castigated about noise last year, but I sympathize with them in their plight. Yessir, now I know why all exhibitors make such a racket! It's just plain self defense. I proved this to my complete satisfaction at least a dozen times. Try to take a lofty view of your exhibit and the fact that you are dealing with classical music. Play your discs or tapes at what approximates concert-hall level for the size and acoustics of the room you are occupying. What happens? People stick their heads in the door, listen for a moment, and duck out again. Not the ghost of a chance to sell your product. Now watch this. Giving the gain control a hearty twist upwards, and calling upon all the resources of your 60 watt amplifier, you soon reach the threshold of pain and a gargantuan orchestra is making mighty sounds. Listen!! Above the roar of the music you can hear the thud of eager rushing feet. Like moths attracted to a flame, the hi-fi bugs are

pouring into your room, to stand transfixed and worship at the shrine of the great god Decibel! When the music (?) ends or your protesting ears ask mercy, the gain is turned down and the exodus from your room begins. It's as simple as that. Keep your room quiet or at a reasonable level and it's empty. Play your music at ear-splitting levels and it's full. I will not go into the solution to this mess. It is too obvious and too difficult for accomplishment.

The story on the boomy bass is somewhat more heartening. There was still plenty of incredibly distorted mud which was supposed to represent the sounds of tympani or bass drum, or big bass viol. But in the main, there was a vast improvement over last year. It was evident that a good many engineers had recognized the problems of cabinet resonance. Most of them took the usual course and employed extra heavy cross bracing, especially on undamped panels. A more lavish use of felt and fiberglass insulating material was noted. It remained for that clever man, G. A. Briggs, to come up with a commercial version of the enclosure which utilizes sand-filled panels. Needless to say, the bass heard from this unit was exceptionally clean and free from unnatural coloration. The trend towards larger enclosures continued. In spite of the fairly good bass response of some of the smaller units, I think the manufacturers and the public are beginning to accept the fact that to get the maximum extension to the lowest frequencies, a large, heavily constructed enclosure of the horn type is a must. The models shown by most of the top loudspeaker companies reflect this attitude. Notable for size and bass response were the *Jim Lansing "Hartsfield,"* the *Jensen "Imperial,"* *Bozak 310* and a really mammoth unit, the *Stan White "4D."* The *Electro-Voice "Patrician"* has been modified considerably over last year's model, having a larger chamber for the 18" woofer and a new mid-range assembly. The result is a low end, even more impressive than the original model. *Stephens* and *University* exhibited multiple speaker arrays in new designs.

There was no shortage of good amplifier designs. The trend here is in two directions; one is the general increase in power output, and the other is the specially packaged, very compact preamp-amplifier combinations which look like a front-end alone. In the power category is a new *Scott* of 65 watts output and a *McIntosh* of (gasp)—200 watts! *Brociner, Scott,* and *Newcomb,* showed packaged units of clever design and impressive specifications. *Fisher* had a 60 watt "Big Bertha" incorporating variable damping, a feature noticed on several other units, too. One of the neatest "gizmos" (to me) was the new

McIntosh C-8 front end. This unit has something I've been seeking for a long time. It has a total of three outputs. This allows you to feed a power amplifier from the main output, another power amplifier from an auxiliary output, and a tape recorder from the third output. In other words, you have a common preamp for two amplifiers, each of which can be used to drive separate loudspeakers. Other clever features are variable impedance on the phono input to match any cartridge and a switch on the phono input which in one position is for the usual magnetic cartridges, and the other for FM (*Weathers* type) pickups. The *Marantz* front end is a most impressive unit, featuring the terrific gain of 56 db, allowing low-level pickups like *Fairchild* and *ElectroSonic* to be used without step-up transformers. In spite of this great gain, hum and noise are noticeably absent.

One of the continuing problems in hi-fi is turntable rumble and it is good to report that there are new weapons available for combating this annoyance. One is a new group of *Rek-O-Kut* units, known as the "Rondine" series. These ruggedized turntables have simplified controls and seem to have a lower rumble factor than earlier *Rek-O-Kut's.* *H. H. Scott* has entered the turntable field with a unit of clever design. Incorporating a new drive and suspension system and strobe regulated variable speed, the rumble factor is said to exceed —60 db. *Components Corporation* showed a new chair-side model of its basic turntable design. In this unit, a specially suspended motor drives a turntable of great mass (25 lbs) through a plastic endless belt. I have been using one of these tables for reviewing and for all practical purposes, rumble is no problem.

New tuners made their appearance and among many excellent designs the *Fisher FM-80, Scott 310,* and the *National "Criterion"* were most notable. Tuning and signal strength meters seem to be in vogue, as witnessed on the *Fisher, Scott,* and *Pilotuner.* The addition of a jack to accept multiplex stereophonic when it ultimately becomes available is a forward-looking feature of the *National* tuner.

In pick-up cartridges and arms, the *Weathers* and *Ferranti* were as impressive as usual, as was a beautifully designed, hand-crafted professional arm and cartridge by *Electro-Sonic.* The announced availability of the new miniature 220 and 240 series *Pickering* cartridges will be welcome news to many. *Fairchild* has a new cartridge with a 4-6 db higher output than the current 215 series, and claims a frequency response flat to 17,000 cycles.

You couldn't turn around without running into a tape recorder at this Fair. Many new small and inexpensive units were introduced and the established boys showed new wares. Notable were the *Magnecord M-80* and *Berlant* broadcast units. *Ampex* showed its 300 line and the very compact 600 model. *Goodell Company* showed a new recorder with an "isometric drive system" which was easily the most sensational exhibit among tape machines. I would have to "live" with this machine for a while before passing any judgment, but on the surface, this new drive looks like it has the answer to a great many problems of recording. Among the tape manufacturers, *Audiotape* exhibited its clever colored tape and mylar base "long play" tape. *Triple M, Reeves,* and *Encore* were also touting the new long play tape (up to 48 minutes on a 7" reel). I hear via the grapevine that a 60 minute 7" reel is not far off. This will really make the small recorders come into their own. Of course, all this "extra-play" timing is at 7½ inch per second speed, but with present day techniques, a fairly good response to 15,000 cycles can be achieved at

(Continued on page 136)

The opinions expressed in this column are those of the reviewer and do not necessarily reflect the views or opinions of the editors or the publisher of this magazine.

A BEAT-FREQUENCY AUDIO OSCILLATOR

By ROBERT G. VAUGHN, JR.

THE general unfamiliarity with methods of dealing with problems presented by the heterodyne audio oscillator has given this circuit the reputation of being a very difficult one with which to obtain satisfactory performance, a reputation only partially deserved. This reputation has caused many technicians to turn to other methods for a source of audio frequency voltages, methods not entirely without problems of their own.

The purpose of this article is to discuss briefly some of the traditional problems of the heterodyne system, and to demonstrate, with a practical example in the form of a complete instrument, successful methods of dealing with them. In this instrument, the conventional and familiar LC oscillator circuits, for which most technicians have an undoubted preference, have been retained, with crystal control of the fixed frequency.

Published articles on audio-frequency generating equipment generally have not been specific concerning the performance of the equipment described and therefore comparisons are difficult. But there is reason to believe the performance of this oscillator is considerably superior to that of the average general purpose service instrument. In support of this belief the following statistics are offered:

Stability: An eight hour period of operation with a deviation in output frequency of less than one cycle-per-second is typical performance.

Oscillator Interaction: Any evidence of any of the effects of oscillator interaction or coupling is entirely absent. There literally is no low-frequency limit short of zero other than that imposed by the audio amplifier.

Waveform: At 50 cycles total harmonic content is approximately one-half of one per-cent.

Range: 0-50 kilocycles.

Output vs Frequency Characteristic: Constant within 3/10 db from 5 cycles to 50 kc., and within 1/10 db, 5 cycles to 30 kc.

Low Frequency Scale: An expanded scale range for the lower octaves to 480 cycles, with 70 cycles at midscale, is available.

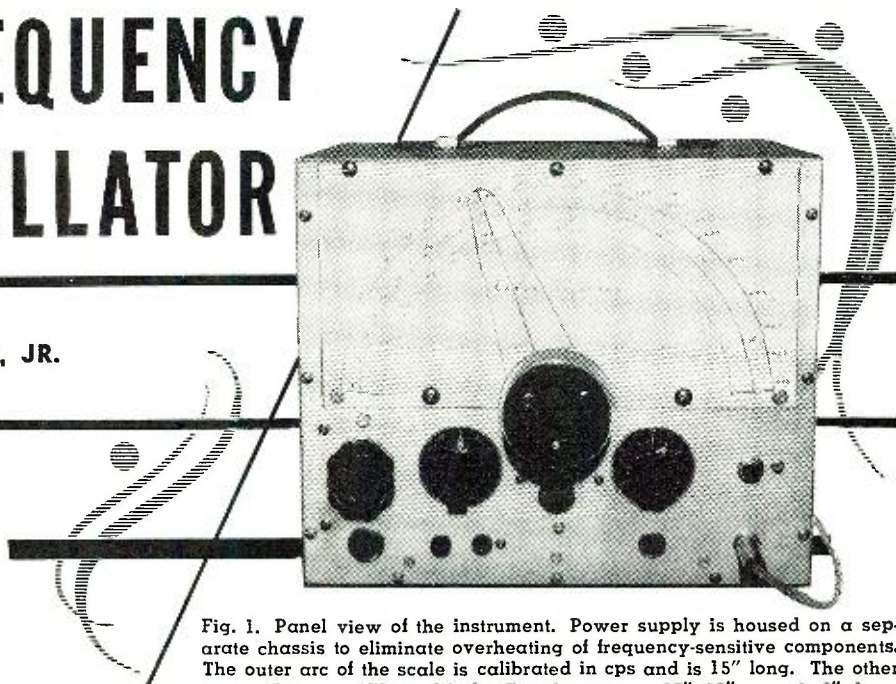

Fig. 1. Panel view of the instrument. Power supply is housed on a separate chassis to eliminate overheating of frequency-sensitive components. The outer arc of the scale is calibrated in cps and is 15" long. The other two scales are calibrated in kc. Panel measures 10"x12", case is 8" deep.

Construction details on a stable service unit that covers 0-50 kc. and features an expanded low frequency scale.

Two problems having exact counterparts in few, if any, other pieces of equipment have come to be regarded as almost inseparable from the heterodyne audio oscillator. These are: the difficulty of avoiding oscillator coupling or interaction and the difficulty of obtaining satisfactory stability of output frequency. The first arises from the fact that a very small amount of coupling is immediately and painfully apparent in waveform distortion, and locking of oscillators. The second, unlike ordinary problems of oscillator stabilization, is largely a result of the percentage magnification of frequency variation inherent in the system. The formidable sound of this phrasing need not be cause for undue alarm, however.

While it is not possible to discuss the problem fully in a single article, it should be emphasized that the possibility of oscillator coupling is greatly reduced and the whole problem simplified if oscillator voltages are limited to the lowest practical amplitudes at all points in the system.

If this is done, electrostatic coupling is avoided without difficulty by using conventional shielding. Elimination of magnetic coupling is not always so simple, nor is the probable effect of remedial measures so readily predictable. For this reason, a procedure that has proved invaluable where coupling between oscillator coils is present or suspected is suggested. Simple, temporary changes in v.f.o. connections are made in accordance with the lower left hand portion of Fig. 2, converting it into an r.f. am-

plifier with tuned-grid circuit. A low range v.t.v.m., connected as shown, indicates any voltage induced in the coil by the fixed oscillator, as well as the effectiveness of corrective measures, when the circuit is tuned to the fixed oscillator frequency. The effectiveness of the scheme can be increased by temporarily increasing plate and screen voltage on the fixed oscillator.

The justification for these precautions is apparent when it is realized that coupling here is often mistaken for a need for further isolation, with the result that additional, and completely ineffective, isolating amplifiers are resorted to in a blind and futile effort to eliminate the trouble.

The important point to remember is that magnetic coupling is most readily avoided by providing a low-resistance path completely around each coil involved. For example, in this instrument, in the case of the v.f.o. coil, this path is provided by the compartment cover, the tuning condenser frame, and the brackets connecting it to the front panel (also part of this path), and to the top and back of the cover. Removal of any one of these brackets is at once reflected in noticeable oscillator interaction.

Past practice has frequently tolerated the presence of harmonics in one of the voltages to be heterodyned. While this in itself may be harmless if the other voltage is entirely free from harmonics, there is reason to question the soundness of this practice. In any case it should be recognized that if harmonics are present in both they will appear in the output as

harmonics of the audio output frequency, in other words, distortion. That harmonics have no place in the heterodyne audio oscillator, and that their generation and presence should be avoided insofar as practicable, is the view adopted in the development of this oscillator. There has been no reason to question its soundness.

The remarkable stability obtained is the result of a combination of factors. Its basis is the stability of the crystal-controlled oscillator whose frequency, for practical purposes, may be said to be unvarying. Thus the problem is resolved into one of v.f.o. stability alone. Here, a factor among others is the relatively enormous value of capacitance used in tuning the v.f.o. tank, a total of approximately 6400 $\mu\text{f.d.}$ at 450 kc. With less than 20 microhenrys of inductance required, a coil of very high "Q" and good dimensional stability in the presence of temperature variation is possible. Further details are given in the following description.

The V.F.O.

The circuit is the versatile and familiar Hartley with a triode. The practical difficulty of obtaining sine-wave voltage from the untuned plate circuit of an electron-coupled oscilla-

tor dictates a triode circuit here. This is no disadvantage from the standpoint of stability, the e.c.o. being no more inherently stable than an unloaded triode, which it is in fact. While it is well known that the frequency of an e.c.o. under certain conditions is substantially unaffected by voltage supply variations, the fact that the same can be said of the triode oscillator is less widely known.

With a triode oscillator circuit in which losses are small, and in which there is close coupling between grid and plate circuits (operated so that the proportion of harmonics generated is small) there is a time constant for the grid resistor-grid condenser combination which will result in its frequency being virtually unaffected by voltage supply variations. With the v.f.o. constants used here, variations in plate voltage of 20%, either way, produced a frequency change of a small fraction of a cycle.

The variable tuning condenser, a very important item, is a 3-gang broadcast receiver type, with identical sections of 420 $\mu\text{f.d.}$ each. One of these sections covers a range of 0-20 kc., which is the "normal" range. Switching to "high" merely cuts in the two remaining sections so that the three are in parallel, and increases the range

to somewhat above 50 kc., the v.f.o. operating on the low side of the fixed frequency of 500 kc. It is, of course, unnecessary to calibrate this range below 20 kc. since it is simply an extension of the "normal" range. For the same reason, the zero reference is the same.

This type of operation provides a linear scale over a large part of the range, with some desirable expansion of scale at the low-frequency end. However, with 20 kc. covered in one band, the need for a separate range for the lower octaves is obvious. To provide this a simple device is employed making available a range covering 0-480 cycles, with a scale that expands progressively as frequency is lowered, 70 cycles being almost exactly at midscale.

It makes use of the fact that when two condensers, one small in comparison with the other, are connected in series, variation of the larger one over a wide range produces only a small change in effective capacitance. The 25 $\mu\text{f.d.}$ trimmer, C_{20} , normally short-circuited, is placed in series with the main tuning condenser section C_{21} , when the range switch is turned to "low." In the initial adjustment, zero beat is obtained in the usual way on the "normal" range. The switch is then

Fig. 2. Complete circuit diagram and parts list covering the beat frequency audio oscillator. All components are standard items.

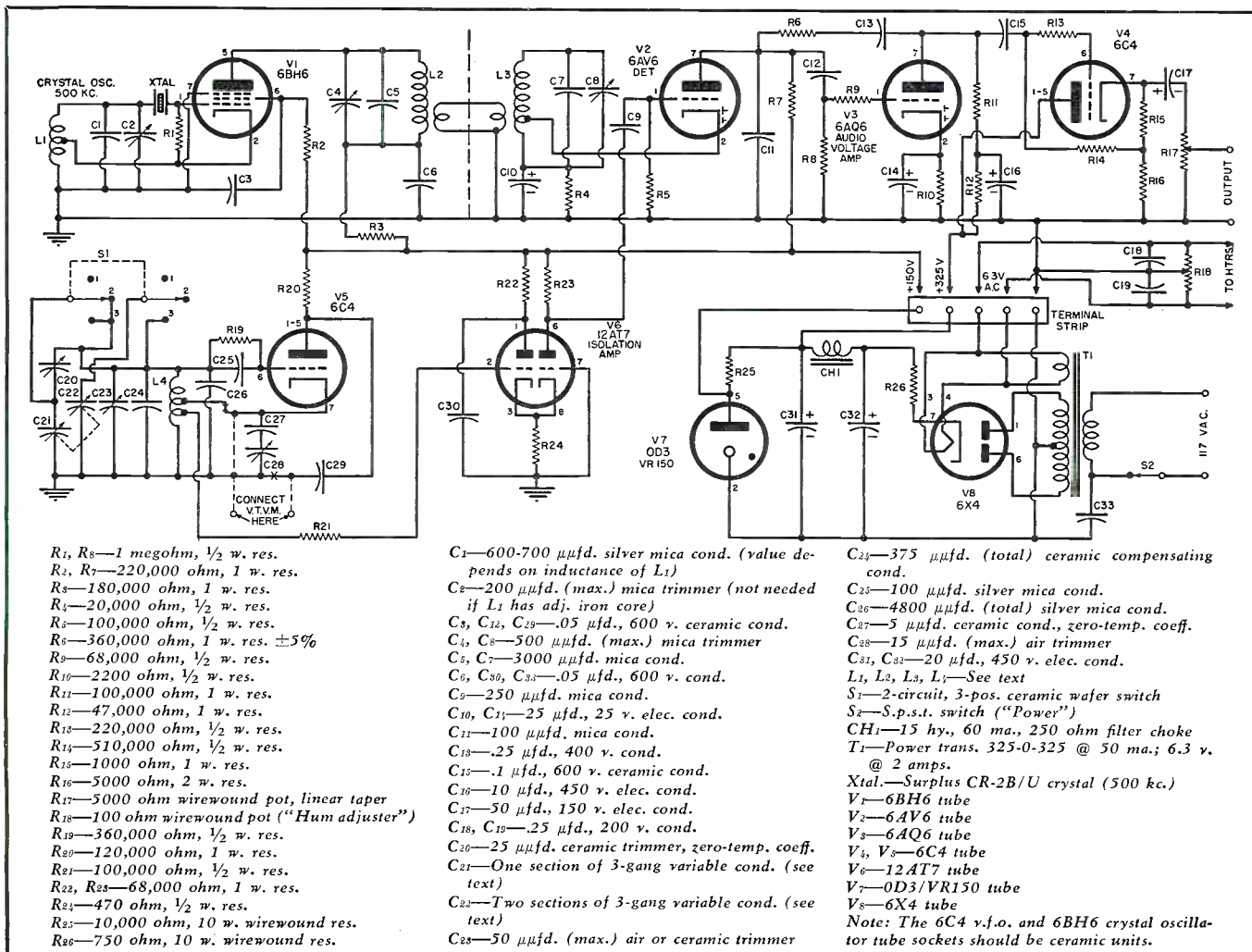

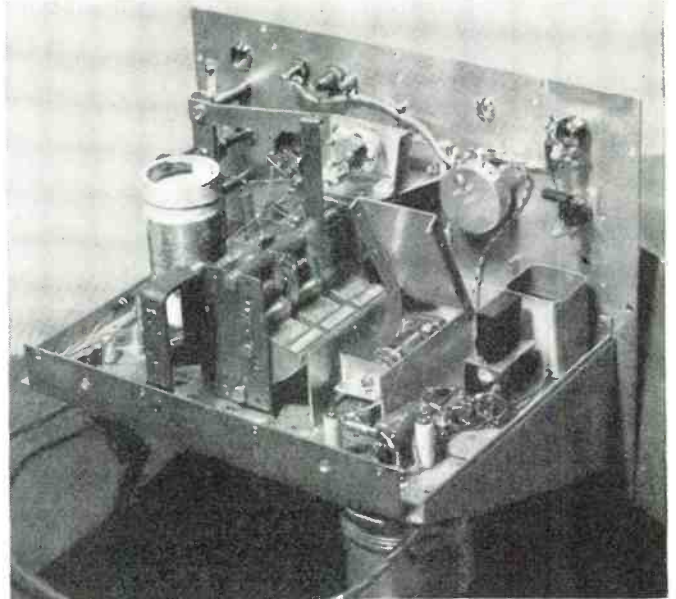
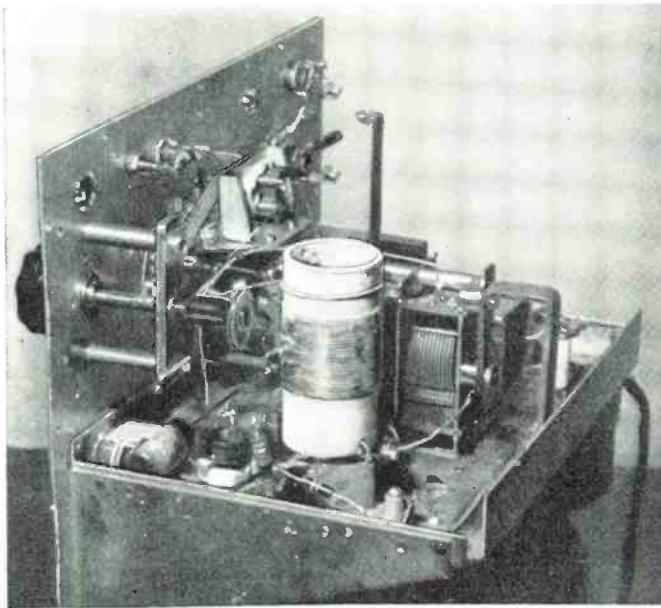

Two underchassis views of the instrument. The photograph at the right shows the oscillator compartment with inner cover removed. The large coil is the v.f.o. inductor. The cover of the rectangular shield at right of tuning condenser is raised to show crystal oscillator plate tank inductance. The crystal can be seen at right, with the oscillator coil shield just behind it. The photo at left shows balance of parts below chassis.

turned to "low," C_{21} is turned to the opposite extreme of its range, maximum capacitance position, and zero beat again obtained, but by means of C_{20} , after which C_{20} is not again disturbed. Any change in C_{21} now can only result in a higher frequency. Therefore the v.f.o. now operates on the high side, the scale is reversed, and tuning C_{21} over its entire range can only produce a change in effective capacitance approximately equal to half its normal minimum capacitance. The scale for this range can be seen in Fig. 1. One zero beat adjustment serves for all three ranges.

Considerable care has gone into the construction of the v.f.o. tank inductance L_1 although it is very simple. It consists of 25 turns of No. 18 bare wire, spaced 16 turns per inch, on a Na-

tional XR 13 ceramic form, 1¼ inches in diameter. The cathode tap is at or near the exact center, the lower tap is ¾ turn from the ground end, and the top turn is spaced out for trimming purposes. The turns are securely cemented to the form. This coil is unshielded and is very rigidly mounted.

Voltage from the lower tap is applied through the 100,000-ohm resistor to the input grid of the 12AT7 cathode-coupled class A amplifier, whose output plate circuit supplies the detector grid. This simple arrangement provides adequate isolation and preserves the sine waveform present at the resonant tank. The r.f. voltage across the tank is about 3.5 r.m.s.

Although the zero-beat adjuster shown in Fig. 2 is a small variable condenser, the one actually used is an

improvised arrangement providing micrometer adjustment of frequency by varying the position of a copper disc in relation to the coil. Since this requires some machine work, the condenser is usually more practical and is entirely satisfactory. Some designs which omitted the zero adjuster, or removed it from the front panel, have been shown. If a heterodyne oscillator never needs zero-beat adjustment you can bet your last dollar, in unperturbed and serene confidence, that the oscillators are locked!

Crystal-Controlled Oscillator

The crystal-oscillator circuit is also a Hartley, this one an e.c.o.

Because the e.c.o. is notoriously prolific of harmonics and in order to pro-

(Continued on page 158)

Rear and top-rear views of the unit with the chassis removed from the case but with oscillator compartment cover in place. The shield at left contains filter coil, L_2 , with its tuning capacitors, also the detector bias resistor and bypass capacitor. All trimmers, except C_{20} , which is accessible from front panel by removing snap-in plug, can be reached from this side of chassis. Note tube sockets raised above chassis and the surface wiring.

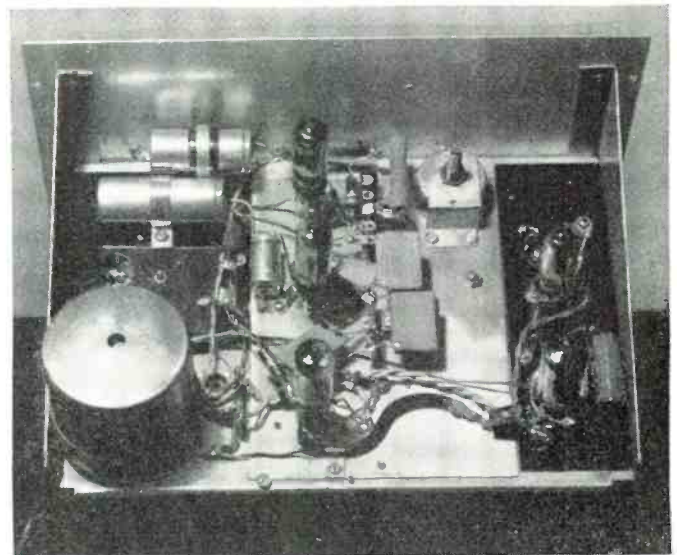
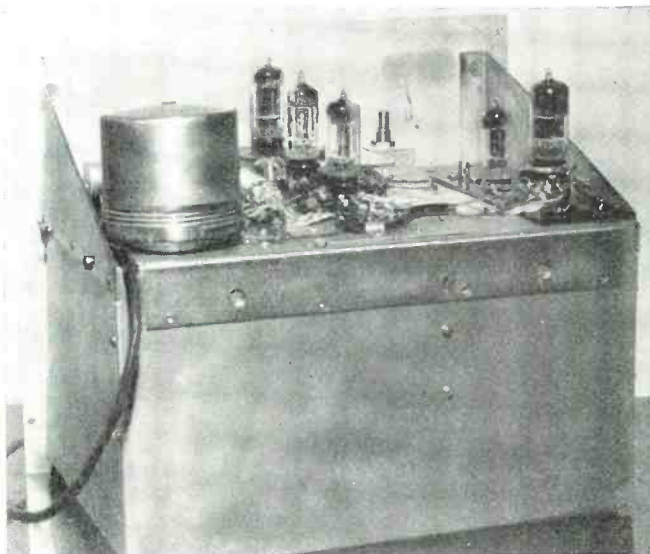
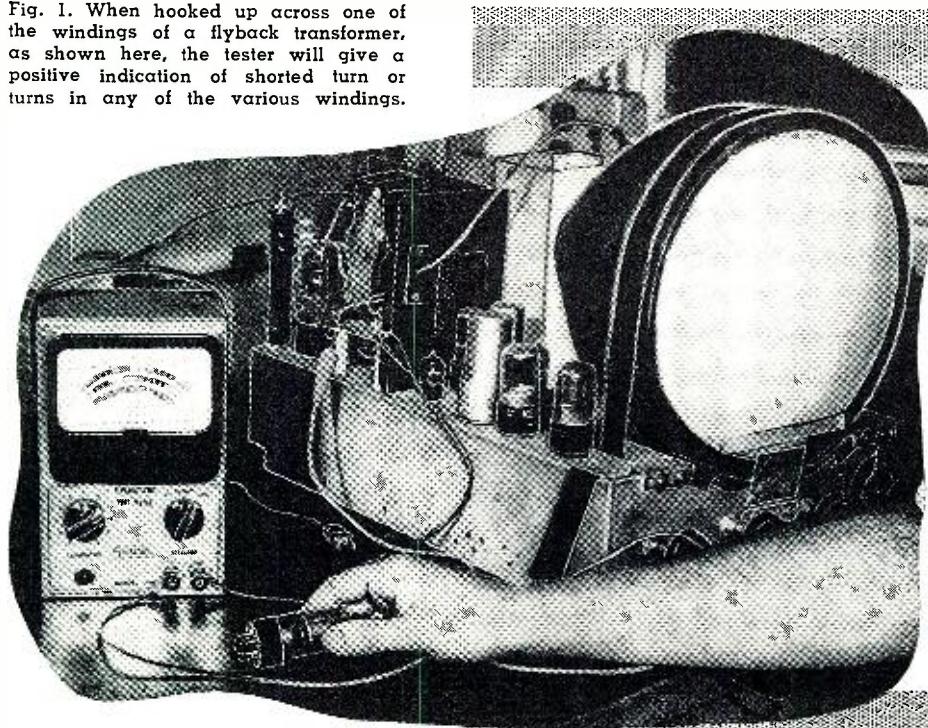

Fig. 1. When hooked up across one of the windings of a flyback transformer, as shown here, the tester will give a positive indication of shorted turn or turns in any of the various windings.



TV FLYBACK AND YOKE CHECKER

By
JACK FREEMAN
Electronic Instrument Co., Inc.

PERHAPS one of the most basic of all TV servicing techniques involves the substitution of a known good component for a suspected malfunctioning unit. Thus, a well equipped service bench will have available such servicing aids as test speakers with universal output transformers, resistance and capacitance substitution boxes, etc. As a rule, however, substitution of components is a means of verifying a troubleshooting analysis rather than constituting in itself a desired analytical procedure. The reasons for this are obvious since in the majority of cases a substitution can be made only by physically disconnecting the suspected part.

In modern receivers, in which compact assemblies are the rule, removal of a unit is not always a simple task and it is desirable to have some other means of isolating a defective component. This is especially true of flyback and r.f. power supplies and deflection yokes where substitution has been the surest check for a long time.

Although simple failures such as open windings are quickly revealed by conventional means, a commonly encountered difficulty is the presence of a few shorted turns in one of the transformer or coil windings. In the case of the flyback power supply diagrammed in Fig. 2, the existence of a few shorted turns in one of the windings of the transformer would not be revealed by a resistance measurement since the shorted turns might account for a decrease of less than 1% of the total resistance of the winding. Such a decrease is insignificant in view of the fact that the resistance of a winding might normally vary 20% from its specified value.

At first glance it might seem that one or two shorted turns would cause

Analysis of a TV flyback transformer and yoke tester designed for the service technician.

only a minor change in the voltage across the winding(s). Thus, for example, if the total number of turns between terminals 1 and 3 in Fig. 2 were 1000 it might be thought that 10 turns shorted together would decrease the turns ratio and therefore the voltage by 10/1000 or 1%. A little thought, however, indicates that the situation is far more serious than this.

During the retrace time, magnetic energy is being stored in the field about the winding. Now, since the rectifier tube draws a very small current (approximately 100 microamperes) substantially all of the magnetic energy which is built up and stored during the retrace portion of the cycle is returned to the circuit during the forward portion of the sweep. If as little as one shorted turn develops in the winding, the shorted turn appears as a secondary winding with zero ohms load resistance and absorbs power from winding 1-3, thus reducing the high voltage output and deteriorating the sweep waveform.

Substantially the same considerations will apply to an r.f. supply or, for that matter, to any similar unit such as the deflection coils. In aggravated cases, the short in the turns may be intermittent, developing only when high voltage transients are present, etc.

For these reasons, the only reliable method heretofore available for checking these components has consisted of substituting a new unit and comparing the operation of the circuit before and after the new unit was inserted. In the case of the flyback transformer particularly, this has been a tedious and time consuming task—to say nothing of the cost and inconvenience of stocking a variety of replacements for testing purposes.

Therefore, the availability of a tester that can check for shorted turns without requiring the removal of the unit from the circuit fills a definite servicing need. One of the popular testers of this type is the *Eico* Model 944 flyback transformer and yoke tester, pictured in Fig. 1 and diagrammed in Fig. 3.

Analysis of the circuit of the tester shows that the heart of the instrument consists of a 6K6 oscillator operating with a.c. plate voltage. This voltage is supplied through the primary of T_2 with T_1 serving as an isolation transformer. Since the plate voltage is raw a.c., the oscillator functions only during positive half cycles of applied voltage and thus is effectively pulsed at a rate of 60 times per second.

T_2 is the feedback transformer through which a portion of the output signal is fed back in phase with the in-

(Continued on page 83)

Fig. 2. Typical flyback-type high voltage circuit used in television receivers.

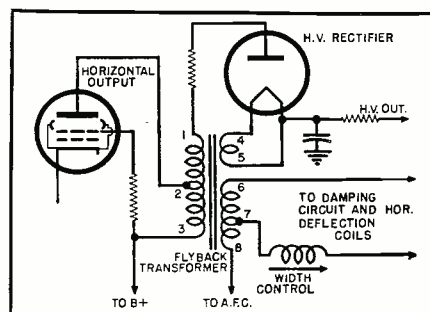

FOR TV . . . IT DODGES

TROUBLE YOU CAN'T STOP

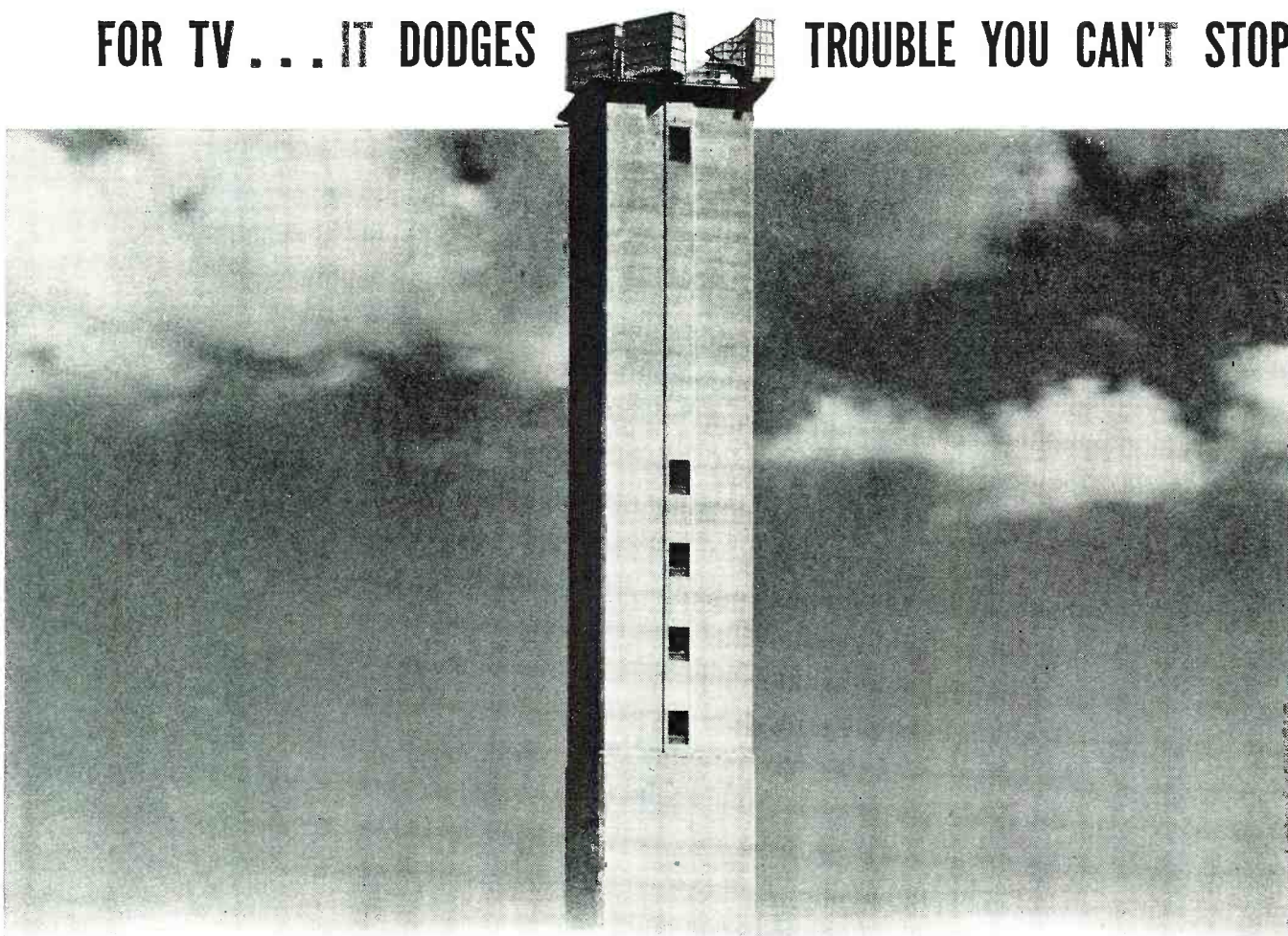

Radio Relay station on route between Chicago, Ill., and Des Moines, Iowa. Every fifth or sixth relaying tower is a control station, where high-speed switching equipment enables a TV picture to skip out of a troubled channel and into a stand-by protection channel faster than the eye can wink.

There's no way to stop atmospheric changes that threaten television with "fade." But, for TV that travels over Bell's Radio Relay System, Bell Laboratories engineers have devised a way to sidestep Nature's interference.

When a fade threatens—usually before the viewer is aware—an electronic watchman sends a warning signal back by wire to a control station perhaps 200 miles away. An automatic switching mechanism promptly transfers the picture to a

clear channel. The entire operation takes 1/500 of a second. When the fade ends, the picture is switched back to the original channel.

This is an important addition to the automatic alarm and maintenance system that guards Bell's Long Distance network for television and telephone calls. It marks a new advance in Bell Laboratories' microwave art, developed to make your Long Distance telephone service, and your TV pictures, better each year.

BELL TELEPHONE LABORATORIES

Improving telephone service for America provides careers for creative men in scientific and technical fields.



Mac's RADIO SERVICE SHOP

By JOHN T. FRYE

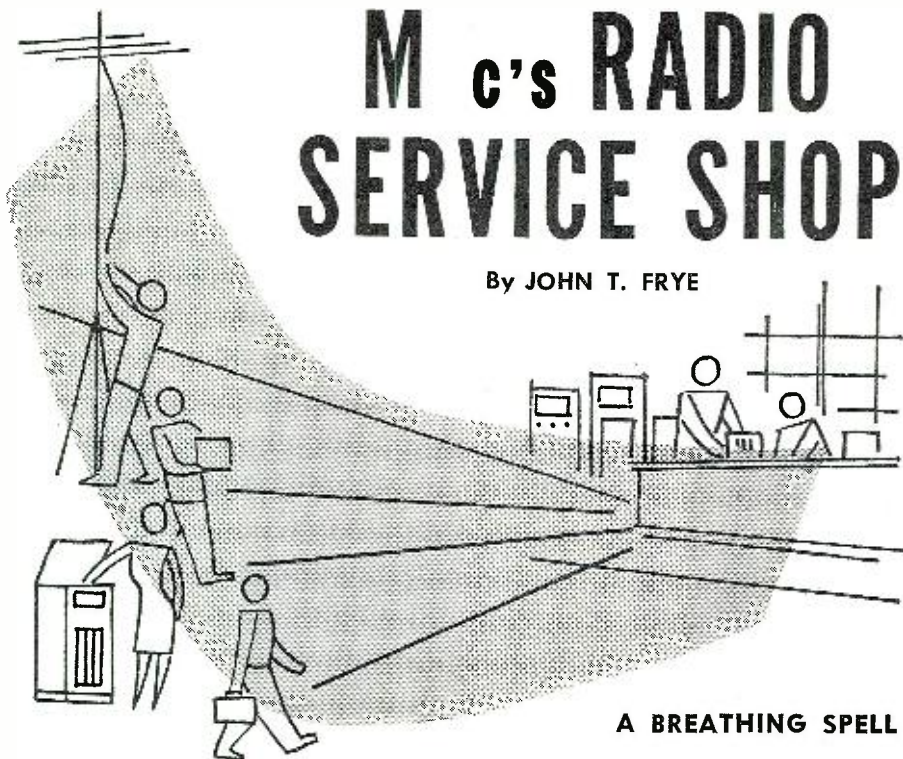

A BREATHING SPELL

THINGS were a little slow in Mac's Radio Service Shop. The holiday season was just over, leaving most people, if not actually broke, at least pretty badly bent. The Christmas radios, phonograph players, and TV sets that refused to play upon presentation had been taken care of in the hectic week between Christmas and New Year's Day. Now there was a lull that was welcomed by Mac's red-headed assistant, Barney, by the "office force" of the shop, Miss Perkins, and even by Mac himself.

The men had been busy most of the day checking and overhauling service equipment that ordinarily could not be spared from active use long enough for this to be done. Signal and marker generators were carefully recalibrated so that their dial readings—at least at the most essential frequencies—were right on the nose. The v.t.v.m.'s had their calibration controls adjusted so their pointers read precisely 1.55 volts when checking a fresh standard flashlight battery. On a.c. they were calibrated to read exactly with Mac's precision type 150 volt a.c. meter when connected in parallel with it across the line voltage. All multiplier ranges of these instruments as well as those of the v.o.m.'s were checked by measuring a wide range of known voltages on the different scales. The ohmmeter sections of both types of instruments were tested for accuracy by measuring several wirewound and precision carbon resistors.

The voltage calibrator used with the oscilloscope was examined to make sure its peak-to-peak voltage indications were accurate; then the vertical inches-per-peak-to-peak-volt sensitivity of the scope was measured at each setting of its step attenuator and with the

fine attenuator set for both maximum sensitivity and at the half-way point. These sensitivities were compared with those measured some time before and arranged in the form of a chart pasted to the case of the instrument. As Mac explained, being able to preset the vertical amplifier to several known sensitivities frequently made it unnecessary to use the voltage calibrator at all. Usually a trace could be adjusted to a suitable size with some setting of the step attenuator and with the fine attenuator adjusted for either maximum sensitivity or at the half-way mark; then the peak-to-peak voltage could be determined simply by observing the height of the trace on the calibrated screen and translating this measurement into peak-to-peak volts by use of the chart's indication of the amplifier sensitivity obtained at that particular setting of the attenuators. Finally, square waves of various frequencies were observed on the oscilloscope to be sure that the frequency response characteristics of its amplifiers had not changed.

Out in the front office Miss Perkins had kept busy checking the advertising mailing lists against the customer records for the past year. The customers who had been into the shop in 1954 would receive a card thanking them for their patronage expressing the hope it would be continued. Customers who had not been heard from during this period would receive the "We've-missed-you-is-anything-wrong?" card. Then there was the new prospect list that Miss Perkins constantly compiled from reading the wedding announcements, new-arrivals-in-town stories, etc. These were slated to receive the "Why-don't-you-give-us-a-try?" card.

At four o'clock, though, she neatly cleared off her desk and quietly slipped out the front door and into the restaurant adjoining the shop. Soon she was back with three huge steaming hamburgers covered with "the works" and with three bottles of Coke to match.

Warm cries of welcome greeted her as she stepped into the door of the service department, and activity there came to a grinding halt. Barney quickly wiped off the top of the service bench stool with the sleeve of his shop coat and proffered her the seat with a flourish that would have done justice to the offer of a throne. She perched herself graciously upon it with her high heels hooked over a top rung while the two men sat side by side on the service bench. For a little while all three munched away in the contented silence that is only possible among friends who know, understand, respect, and like one another.

Finally Matilda turned to Mac and said, "Mac, your wife called me before Christmas and wanted some suggestions about a Christmas present for you. I took a chance and told her I thought you might like a tape of pre-recorded music and suggested two or three sources of these. Did you find anything like that in your stocking?"

"Sure did, Matilda; and I thank you for saving me from the usual Christmas ties. She bought me two of Hack Swain's five-inch, dual track *Musikon* tapes recorded at 7½ inches per second. The selections on these two tapes include piano, organ, and vocal numbers. Several of the organ selections are of the multi-track recording type that Les Paul and Mary Ford have made famous. All in all, these tapes are exactly what I wanted—to coin a yuletide phrase. Seriously, for a long time I've wanted to see for myself just how good pre-recorded tapes sound on my own recorder."

"Well," Barney demanded, "how do they sound?"

"Much as it pains me," Mac replied, "I've got to admit that a professional tape recording sounds better than anything I've been able to accomplish at home. Naturally, I expected this. After all, these recordings are made in studios with properly engineered acoustics; the recording equipment, including microphones, is the best obtainable; and the people doing the recording have considerable more know-how than most of us amateurs. All this shows up in noticeably improved fidelity, better signal-to-noise ratio, better microphone technique, and all around more pleasurable listening. I fully intend to buy some more pre-recorded tapes from various manufacturers. The fellow who has never heard one simply does not know how good the playback portion of his tape recorder can sound."

"Not to change the subject," Barney broke in, "but I'm wondering how you like the new TV antenna you put up at home back in September. You've

(Continued on page 88)

P. R. MALLORY & CO. INC.
MALLORY
APPROVED PRECISION PRODUCTS

P. R. MALLORY & CO. INC.
MALLORY
APPROVED PRECISION PRODUCTS

P. R. MALLORY & CO. INC.
MALLORY
APPROVED PRECISION PRODUCTS

You've made them the leader FOR 25 YEARS

Ever since Mallory introduced the first commercial vibrators 25 years ago, they have consistently led the field. They have led . . . and are still leading . . . not only in quality but also in acceptance by service men and manufacturers alike.

Service men prefer them. Surveys show that 5 out of 6 service men use Mallory vibrators for replacement work.

Set manufacturers prefer them. More Mallory vibrators are used as original equipment than all other makes combined.

Now better than ever. New standards of quiet operation are set by the latest Mallory vibrator. A floating mounting for the internal mechanism cushions out hum . . . makes these the quietest vibrators ever.

See your distributor today. Ask him about the special Mallory Vibrator Deal—6 vibrators that cover 75% of your replacement jobs. And get a copy of the latest Mallory Vibrator Guide.

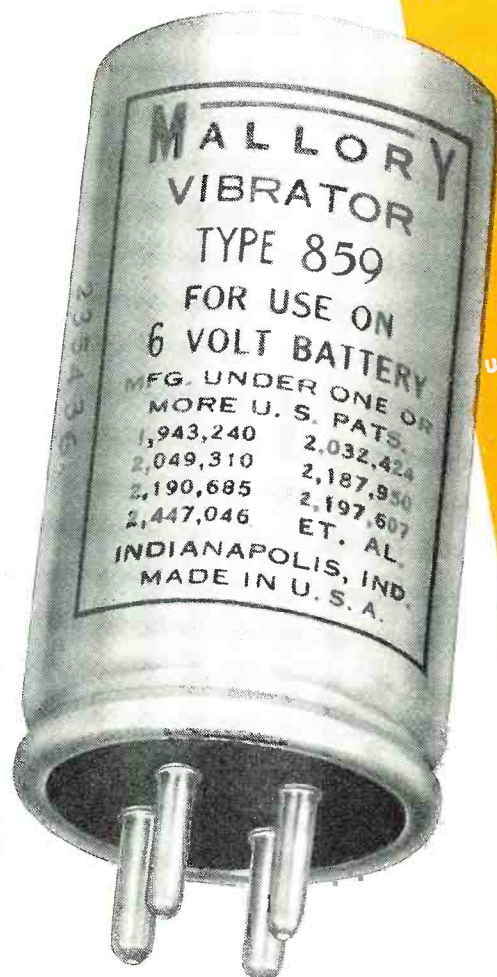

ON AUTO RADIO JOBS BE SURE TO USE . . .

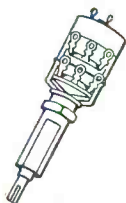

MALLORY MIDGETROLS®—Simplified design cuts replacement time to minutes. Accurate tapers, noise-free operation, and excellent stability. Versatile line of single and dual types.



MALLORY CAPACITORS—FP electrolytics . . . the only fabricated plate capacitors for replacement work . . . have long life even at 85° C. Plascaps®, tubular plastic type, have permanent, moisture-proof terminal seals.

P. R. MALLORY & CO. INC.
MALLORY

CAPACITORS • CONTROLS • VIBRATORS • SWITCHES • RESISTORS
RECTIFIERS • POWER SUPPLIES • FILTERS • MERCURY BATTERIES
APPROVED PRECISION PRODUCTS

P. R. MALLORY & CO. Inc., INDIANAPOLIS 6, INDIANA

P. R. MALLORY & CO. INC.
MALLORY
APPROVED PRECISION PRODUCTS

P. R. MALLORY & CO. INC.
MALLORY
APPROVED PRECISION PRODUCTS

P. R. MALLORY & CO. INC.
MALLORY
APPROVED PRECISION PRODUCTS



International SHORT-WAVE

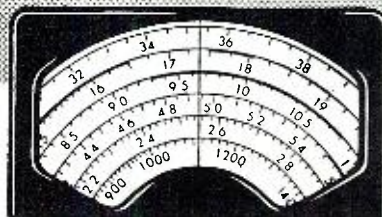

Compiled by **KENNETH R. BOORD**

AMATEUR Weston H. Lewis, Box 73, Kingston, St. Vincent, British West Indies, has informed Paul Mathieu, Mass., that each Sunday afternoon *EST* he runs an hour's program for the government. The broadcast consists of 15 minute periods of news and sports commentary, music or variety, feature talks, and a religious service which brings the program to an end.

Does *not* verify, but if Lewis receives any reports, he says he may mention them in station announcements preceding the news.

"I am first and foremost an amateur," he wrote, "but in order to assist the government for propaganda purposes, I merely tune to 3.336 and put on the broadcast. As a matter of fact, I use my 40-meter antenna for the broadcast and that is why I only run 400 watts as I am capable of running a full gallon. I tried recently to get material for putting up a 90-meter antenna but none was available here and I have not bothered since. It means that I would have to import it."

If anyone hears this one, please advise Ken Boord. Thanks!

* * *

Radio Club Notes

Austria—The Austrian DX-Club, Vienna, in 1955 will have a "diploma" of four different classes.

England—The International Short Wave Club, which was started in the USA, recently observed its 25th anniversary.

Japan—The International DX League, Box 56, Kyoto Central Post Office, Japan, welcomes members anywhere in the world and has new worldwide awards program and regular contests for both SWL's and licensed amateurs. (Yoshida, Japan)

Norway—Kristiansunds DX-Club, Haukveien 1, Kjos Haveby, Kristiansund S, Norway, would like to increase its membership; issues membership card and its monthly bulletin is called "SWL." President of this club is Per A. Thorstensen; secretary is Stein Gjeruldsen.

USA—"On the Air" bulletin now confines itself largely to interesting features about short-wave radio stations; is published by Bruce Cushman, 133 Summer St., Kingston, Mass., USA. The Newark News Radio Club has just celebrated its 27th birthday.

* * *

Around the World

Afghanistan—Kabul Radio, 9.975,

made a rare appearance on a Saturday some weeks ago 1212-1245 sign-off in *English*. (Sutton, Ohio)

Anglo-Egyptian Sudan—Radio *Omdurman*, 4.995A, noted 1330 with Arabic vocals. (Pearce, England)

Angola—CR6RA, 11.862, Loanda, noted with variety program 1500-1630. (Sutton, Ohio)

Australia—VLW9, 9.610, Perth, noted around 1100-1130 recently. (Lund, Calif.) VLC9, 9.615, is good level in Eastern North American beam 0700-0845; DX session Sunday 0830. (Gilcher, Ohio, others) VLB11, 11.810, noted 0330 with news, music. (Parker, N. H.)

Austria—Direct from Clifford E. Meyers, DA Civilian Chief Engineer, *Blue Danube Network*, APO 168, US Army, New York, N. Y., it is learned that the 9.617 outlet at Salzburg has been closed down for an indefinite period; listeners are invited to tune to 5.03 or 3.27 in the future. DX-Radio, Sweden, says *Radio Osterreich*, 11.785, Vienna, is heard in Sweden 0045 with news in German; is noted by Pearce, England, on 9.664 at 0213 with program preview in German.

Azores—Ponta Delgada now uses its 4.865 channel 1500-1600, 1615-1900. (ISWC, London; Pearce, England, others)

Belgian Congo—OTC, 9.655, Leopoldville, noted 2000-2200 in *English* for North America, with relay of ORU, Brussels. (Herrmann, N. H., others) OTM1, 9.380, Leopoldville, good level with news in French 0100 tune-in. (Cox, Dela.)

Belgium—When this was compiled, Brussels was trying out 5.990, instead of 6.000, in beam to Scandinavia 1300-1500; *English* for North America 2000-2200 is now over 9.144, 6.085, 9.705 with relay by Leopoldville, 9.655.

Bolivia—CP5, *Radio Illimani*, 5.970, La Paz, is heard in Sweden 2000-2100. (Nattugglan)

Brazil—WRH reports as *new*, *Radio Progresso* on 4.775; QRA is Caixa Postal 2071, Sao Paulo. Cox, Dela., notes PRL4, 9.770, Rio de Janeiro, fair with news or talk in Portuguese when

tuned 2010. Earnhardt, N. C., notes PRB23, 15.135, good level 1855. Saylor, Va., says *Emissora Nacional*, 6.125, Sao Paulo, opens 0400 at fine level in Portuguese, may be old "Radio Excelsior."

British Guiana—ZFY, 3.255, Georgetown, noted 2040 at fair level in Va. (Churchill)

British Honduras—Radio *Belize*, 3.300, noted 2145, left air 2200 and announced use also of m.w. 1280 kc. (Chamberlayne, Va.) In verifying, listed schedule of 1300-1400, 1900-2200 on 3.300, 4.950, 6.100, 1280 kc. (Hardwick, N. Z.)

British New Guinea—VLT6, 6.130, Port Moresby, fair 0330 with religious program. (Cox, Dela.)

Bulgaria—Radio *Sofia*, 7.671, fair to good with *English* 1500-1508, excellent in *English* for Europe 1700-1730. (Cox, Dela.) Heard on 6.070 to North America 1930-2030. (Niblack, Ind., Parsons, Pa.) And 2300-2330. (Churchill, Va.)

Canada—CHNX, 6.130, Halifax, Nova Scotia, is good level around 2235. (Chamberlayne, Va.) CFRX, 6.070, Toronto, Ont., noted around 0700, good level in Ga. (Goodrum) VE9AI, 9.540, Edmonton, Alta., noted 1110 with music, poor level in N. Y. (Wilhelm) CBUX, 6.160, Vancouver, B. C., noted 0300 at weak level with sports scores and weather forecast, closed 0310 with "God Save the Queen." (Cox, Dela.) CBNX, 5.970, St. John's Newfoundland, opens 0500 with "Marching Strings." (Collett, N. Z.)

Canary Islands—EA8AB, 7.505A, Tenerife, noted with musical program in Spanish 1535; weak, CWQRM. (Cox, Dela.)

Cape Verde Islands—CR4AA, 7.398AV, Praia, noted 1630 with news in Portuguese; closed 1700A with "A Portuguesa." (Mathieu, Mass., others) Has been heard in parallel over 3.925 at 1630. (*La Radio Mondiale*, France)

Chile—CE1515, 15.150, Santiago, *Radio Corporacion*, is good level 1800 with popular music; on Sat. 1830 has South American sports results; all-Spanish. (Kahan, Calif.) Chilean heard on 11.940 must be CE1190, Valparaiso, noted on a Thursday 1930-1935 with Spanish-*English* lesson; had heavy QRM from *Voz de Dominicana* harmonic on 11.940. (Niblack, Ind.) CE960, 9.593, Santiago, noted to 2230 closedown. (Ferguson, N. C.)

China—Radio *Peking*, 7.500, noted at weak level 0710 with native music,

(Note: Unless otherwise indicated, all time is expressed in American EST; add 5 hours for GCT. "News" refers to newscasts in the English language. In order to avoid confusion, the 24 hour clock has been used in designating the times of broadcasts. The hours from midnight until noon are shown as 0000 to 1200 while from 1 p.m. to midnight are shown as 1300 to 2400.) The symbol "V" following a listed frequency indicates "varying." The station may operate either above or below the frequency given. "A" means frequency is approximate.

The Guide has achieved instant recognition as the leader among moderately priced high fidelity tuners.

Brilliant engineering and skillful styling have combined to endow the GUIDE with appearance, performance and operating features normally found only in the most expensive tuners.

There are features you can see... the compact beauty, colorful edge-lit slide rule dial set into a brushed copper escutcheon with jet black knobs.

There are features you can feel and hear... counter-weighted tuning control for a smooth, professional "feel" when tuning... Harman-Kardon no-drift Automatic Frequency Control (AFC) to simplify tuning—make it smooth, easy, certain—and to automatically lock the station in, once it has been tuned.

Armstrong FM circuitry... astonishing sensitivity and response... Quality AM performance, quiet between stations, full and clear on station... *plus* Harman-Kardon's exclusive built-in rotatable AM ferrite loop-stick antenna.

Additional features: Low noise front end using grounded grid amplifier. Built-in power supply and bottom plate. AFC Defeat combined with Tuning Control. Simplest possible cabinet installation.

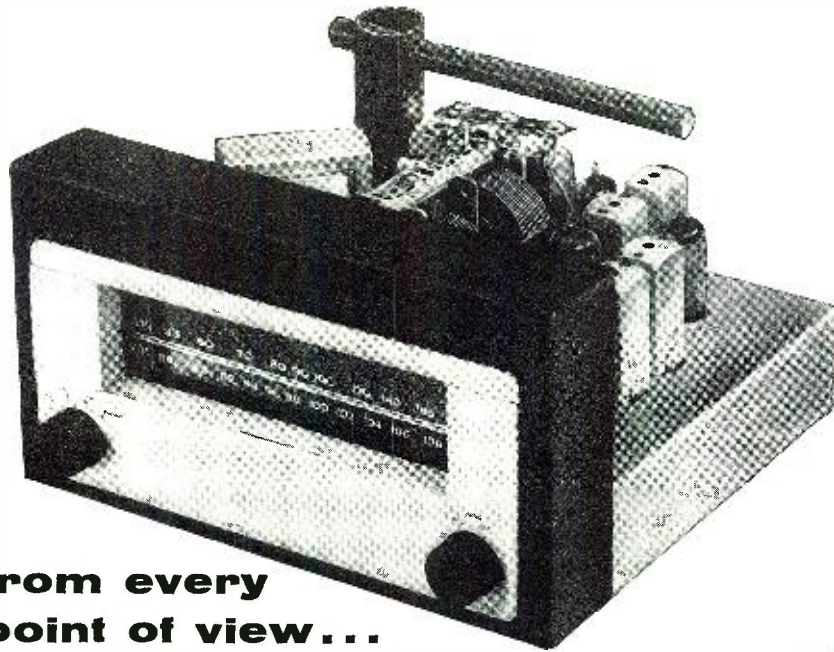

from every point of view...

harman kardon

Guide model A200

best buy \$69⁵⁰ net
am-fm tuner Zone 2: \$70.50

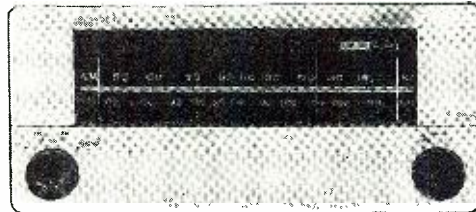
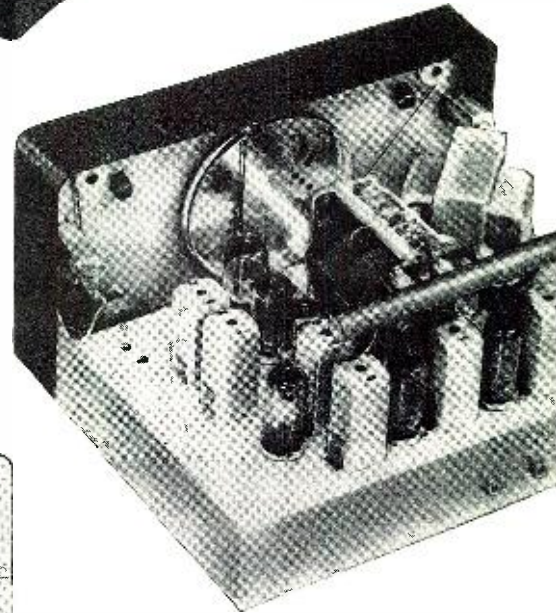

Manufactured by HARMAN-KARDON, INC., Westbury, New York

Prices and Specifications Subject to Change Without Notice

The Harman-Kardon "Guide" is Sold and Serviced Throughout the Country by These and Other Leading Specialists in High Fidelity

<p>Boston, Mass. RADIO SHACK CORP. 167 Washington St. Lafayette 3-3700 Write For Free Hi-Fi Catalog</p>	<p>New York, N. Y. ARROW ELECTRONICS, INC. 65 Cortlandt Street Digby 9-4714 Always An Audio Fair</p>	<p>New York, N. Y. LEONARD RADIO, INC. 69 Cortlandt Street Cortlandt 7-0315 The House Built On Service</p>	<p>Chicago, Illinois ALLIED RADIO CORP. 100 N. Western Avenue Haymarket 1-6800 World's Largest Stocks Of Hi-Fi Components</p>	<p>Phoenix, Arizona AUDIO SPECIALISTS 333 Camelback Road Amherst 5-0447 Arizona's Leading Hi-Fi Center</p>	<p>Los Angeles, California GATEWAY TO MUSIC 3089 Wilshire Blvd. Dunkirk 7-3393 Authoritative Hi-Fi Guidance</p>
<p>Buffalo, N. Y. RADIO EQUIPMENT CORP. 147 Genesee Street Madison 9676 Empire State's High Fidelity Center</p>	<p>New York, N. Y. FEDERATED PURCHASER 66 Dey Street Digby 9-3050 Also Newark, Easton, Allentown, Los Angeles</p>	<p>Yonkers, N. Y. WESTLAB 2475 Central Ave. Spencer 9-4400 In Westchester, It's Westlab</p>	<p>Chicago, Illinois NEWARK ELECTRIC CO. 223 W. Madison St. State 2-2950 Write For Complete Hi-Fi Catalog</p>	<p>Hollywood, California HOLLYWOOD ELECTRONICS 7460 Melrose Avenue Webster 3-6208 Hi-Fi Components Exclusively</p>	<p>Montreal, Canada CANADIAN ELECTRICAL SUPPLY CO. 275 Craig Street, W. University 1-2411 Toronto and Edmonton Branches</p>
<p>Philadelphia, Pa. RADIO ELECTRIC SERVICE CO. 709 Arch Street Lombard 3-7390 Allentown & Easton Branches</p>	<p>New York, N. Y. HUDSON RADIO & TELEVISION CORP. 48 West 48 Street Circle 6-4060 3 Metropolitan Area Salesrooms</p>	<p>Washington, D. C. ELECTRONIC WHOLESALERS 2345 Sherman Avenue, N. W. Hudson 3-5200 For Everything In Audio</p>	<p>Chicago, Illinois VOICE AND VISION, INC. 53 East Walton Whitehall 3-1166 High Fidelity Exclusively</p>	<p>Pasadena, California HIGH FIDELITY HOUSE 536 South Fair Oaks Ryan 1-8171 World's Finest Music Systems</p>	<p>HARMAN-KARDON, INC. Westbury, N. Y. Send "Guide" Literature. NAME ADDRESS CITY..... STATE.....</p>

MAIL THIS COUPON →

THE American IDEA

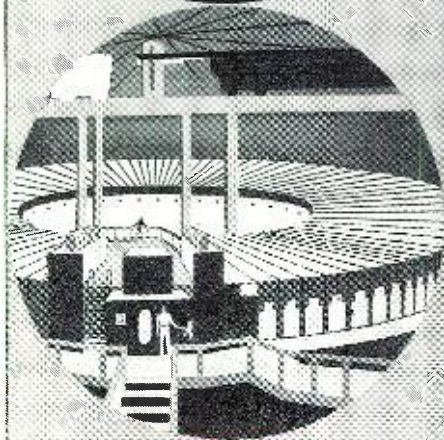

"To find and follow the better way"... Gigantic offspring of the cyclotron, the Bevatron—world's greatest magnet—can send masses of protons hurtling around its 135' diameter race track at almost the speed of light. "Idea", to penetrate deep into the atomic nucleus, where lie secrets of matter and energy.

With us, the "American Idea" is, by directed effort and applied know-how, to continue to lead in bringing you electronic products of the highest quality.

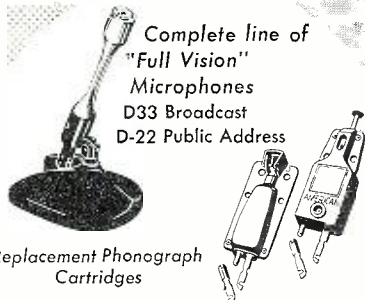

Complete line of
"Full Vision"
Microphones
D33 Broadcast
D-22 Public Address

Replacement Phonograph
Cartridges

INSIST ON AMERICAN FOR QUALITY
Send for FREE Catalog 47

American microphone co.

370 South Fair Oaks Ave. • Pasadena, 1, Calif.

CWQRM. (Cox, Dela.) Has replaced 15.385 with 11.960 for news 2200-2230, with 15.100 and 15.06AV noted parallel. (Balbi, Calif.) Shanghai, 9.735A, is heard in Japan 2130 with Chinese; takes many relays from Peking. (JSWC)

Cook Islands—ZLIZA, 6.180, now operates Tuesday, Thursday 2000-2100, Wednesday 2330-2400, with 500 watts; programs Tuesday, Thursday are by Cook Islands Further Education Dept., Wednesday broadcast is news, music. (N. Z. DX Times via Winch, Calif.)

Costa Rica—TIHBG, 6.008, San Jose, good level with Spanish music 1850. (Cox, Dela.) TIFC noted closing in Spanish, English 2400 on 6.037, parallel 9.647A. (Niblack, Ind.) Noted over latter with religious program in Spanish 0730-0745 when identified. (Thurber, N. Y.)

Cyprus—ZJM8, 9.650, Limassol, noted at weak level 2308 tune-in, Arabic chanting. (Cox, Dela.) Heard with English lesson 1215, fair level in N. Z. (Hardwick)

Denmark—Copenhagen, 15.165, noted 0912 in Danish, fair level with much QRM from ZYN7, Brazil, same channel. (Earnhardt, N. C.)

Dominican Republic—HI1N, 6.044A, Ciudad Trujillo, fair level with Spanish music 1915. (Cox, Dela.)

Dutch New Guinea—Radio Hollandia, 3.390, opens around 0430 or 0500. (Collett, N. Z.)

Ecuador—H02AJ, 4.660, Guayaquil, fair level with Spanish music when tuned 2120. (Cox, Dela.) HCJB, 9.743A, noted at good level 0700, religious session. (Thurber, N. Y.) And around 2230. (Grosman, D. C.)

Egypt—Radio Cairo, 12.033A, fair level with Arabic music 1340; 9.785A good signal 1150 with native music, classical music 1420. (Cox, Dela.) Is fine signal on 9.475 at 1320-1600 (some days to 1700); news 1330. (Saylor, Va., others)

Ethiopia—Radio Addis Ababa, ETAA, 15.342A, noted 1215 tune-in with native-type music; weak in Dela. (Cox) Recently measured 15.340 at 1415. (Ferguson, N. C.) Heard in Calif. as early as 1235. (Balbi)

Finland—OIX4, 15.190, noted in Australia 0430 with English. (Radio Australia)

French Cameroon—Radio Douala has been testing on new 9.850 at 1230-1500; peaks around 1430. (La Radio Mondiale, France)

French Equatorial Africa—Radio Brazzaville, 15.595, weak level 1340 tune-in, music and announcements in French. (Cox, Dela.) Noted on 11.970 with news 1745-1800. (Chamberlayne, Va.) Heard with news on 9.440 at 1545-1600. (Thurber, N. Y., others.) Noted to Latin America around 2000. (Everle, Conn.) Strong in Calif. when closing 2040A. (Kapp) Radio A.E.F., 9.965A, noted with weak to fair signal when tuned 1445, music announcements by woman in French; closed down 1500 with "La Marseillaise."

French Morocco—CNR3, 6.006, Rabat, noted 0238 with man giving talk or news in French; weak to fair; iden-



This attractive listening post of Emmet J. Riggle, Massillon, Ohio, is equipped with a recorder, a BC-221 frequency standard, a 50, 21, 28, 14-mc. converter, and a Hammarlund Super-Pro receiver. Emmet DX-es on both amateur and international short-wave bands. Perhaps his best phone pickup was XIUB, China, running 30 watts. Another rare one was VR6AA, Pitcairn Island, whose operator, Andrew Young, is a direct descendant of "the mutineers." He also logged a pioneer short-wave broadcaster in Costa Rica which ran only 3 watts.

tified with "Ici Rabat" 0245; weak level 1610 with songs in French, man announcer. (Cox, Dela.)

French West Africa—Radio Coteneau, Box 366, Coteneau, Dahomey, operates on 7.190 with 0.28 kw. and on 1480 kc., 1 kw., 0130-0200, 1200-1415; news in French 1345. (WRH) Radio Dakar's 4.950 outlet has been heard in Germany at good strength 1515-1630. (Radio Sweden) Noted 1543 with lively music, French announcements; the 9.560 channel is good 1438 with music. (Cox, Dela.) Radio Dakar, 11.895A, noted 0700-0845 and also to 1730 closedown. (Stark, Texas) By now should have new 25 kw. transmitter in operation on this frequency, replacing old 12 kw. rig. (La Radio Mondiale, France)

Germany—Radio Liberation, 3.985, fair level 1745; had QRM from hams at times. Baden-Baden, 7.265, good level with classical music, German language 0123; news in German 0100. (Cox, Dela.) AFN, 3.188A, Frankfurt, 10 kw., is good level in N. Z. 0200. (Collett) Leipzig, 9.730, noted 0115 with news in German. (Sanderson, Australia)

Cologne's Overseas Service now uses "foreign" languages and three transmitters in all transmissions—0530-0830, 9.640, 11.795, 15.275; 0930-1230, 7.290, 9.640, 11.795; 1300-1600, 7.290, 9.640, 11.795; 1700-2000, 5.980, 7.290, 9.640; 2030-2330 (to North America), 5.980, 7.290, 9.735; has news in English and French (five minutes of each) beginning 0630, 1030, 1400, 1800, 2130.

Greece—Radio Athens now uses 9.607 for French 1230-1245, and English 1245-1300 closedown; fair level in Ohio. (Sutton)

Greenland—WRH says AFRS at Thule Airport is operating on 4.425 with 1 kw.

(Continued on page 162)

ADVANCE! Raise your earning power—learn RADIO-TELEVISION-ELECTRONICS by SHOP-METHOD HOME TRAINING

GOOD JOBS AWAIT THE TRAINED RADIO-TV TECHNICIAN

There is a place for *you* in the great Radio-Television-Electronics industry when you are trained as National Schools will train you at home!

Trained technicians are in growing demand at good pay—in manufacturing, broadcasting, television, communications, radar, research laboratories, home Radio-TV service, and other branches of the field. National Schools Master Shop-Method Home Training, with newly added lessons and equipment, trains you in your spare time, right in your own home, for these fascinating opportunities. OUR METHOD IS PROVED BY THE SUCCESS OF NATIONAL SCHOOLS TRAINED MEN, ALL OVER THE WORLD, SINCE 1905.

EARN WHILE YOU LEARN

Many National students pay for all or part of their training with spare time earnings. We'll show you how you can do the same! Early in your training, you receive "Spare-time Work" Lessons which will enable you to earn extra money servicing neighbors' and friends' Radio and Television receivers, appliances, etc.



Signal Generator

Audio Oscillator

T. R. F. Receiver

National Schools Training is All-Embracing

National Schools prepares you for your choice of many job opportunities. Thousands of home, portable, and auto radios are being sold daily—more than ever before. Television is sweeping the country, too. Co-axial cables are now bringing Television to more cities, towns, and farms every day! National Schools' *complete* training program qualifies you in all fields. Read this partial list of opportunities for trained technicians:

- Business of Your Own • Broadcasting
- Radio Manufacturing, Sales, Service • Telecasting
- Television Manufacturing, Sales, Service
- Laboratories: Installation, Maintenance of Electronic Equipment
- Electrolysis, Call Systems
- Garages: Auto Radio Sales, Service
- Sound Systems and Telephone Companies, Engineering Firms
- Theatre Sound Systems, Police Radio
- And scores of other good jobs in many related fields.

TELEVISION TRAINING

You get a complete series of up-to-the-minute lessons covering all phases of repairing, servicing and construction. The same lesson texts used by resident students in our modern and complete Television broadcast studios, laboratories and classrooms!

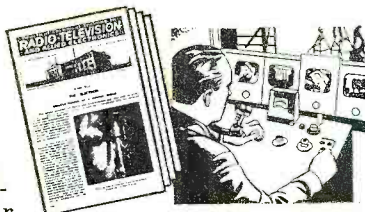

MASTER ALL PHASES!

Get Master Shop-Method Home Training from an Established Practical Resident School with its own Training with its own Training Successful Experience in Training Ambitious Men. We Bring National Schools To You!



Shops, Laboratories, Studios — almost 50 Years of Successful Experience in Training Ambitious Men.

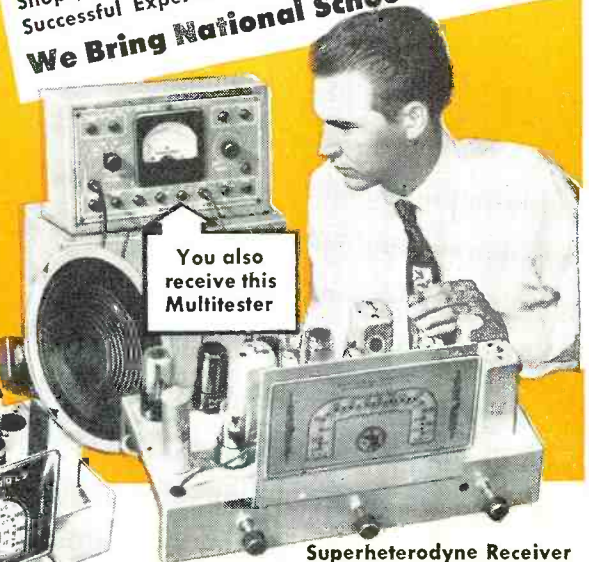

You also receive this Multitester

Superheterodyne Receiver

LEARN BY DOING

You receive and keep all the modern equipment shown above, including tubes and valuable, professional quality Multitester. No extra charges.

FREE! RADIO-TV BOOK AND SAMPLE LESSON!

Send today for National Schools' new, illustrated Book of Opportunity in Radio-Television-Electronics, and an actual Sample Lesson. No cost—no obligation. Use the coupon now—we'll answer by return airmail.

APPROVED FOR VETERANS AND NON-VETERANS Check coupon below

Both Resident and Home Study Courses Offered!

NATIONAL SCHOOLS

LOS ANGELES 37, CALIFORNIA • ESTABLISHED 1905
IN CANADA: 811 W. HASTINGS STREET, VANCOUVER, B.C.



GET FACTS FASTEST! MAIL TO OFFICE NEAREST YOU!

(mail in envelope or paste on postal card)

NATIONAL SCHOOLS, Dept. RH-15

4000 S. Figueroa Street or 323 West Polk Street
Los Angeles 37, Calif. or Chicago 7, Ill.

Send FREE Radio-TV Electronics book and FREE sample lesson. No obligation, no salesman will call.

NAME _____ BIRTHDAY _____ 19____

ADDRESS _____

CITY _____ ZONE _____ STATE _____

Check if interested **ONLY** in Resident Training at Los Angeles.
VETERANS: Give Date of Discharge _____

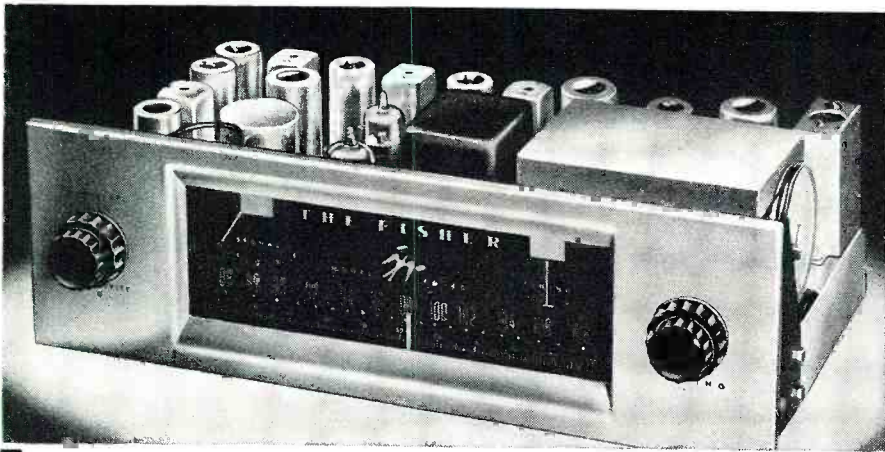

Now! Micro-Tuning!

THE FISHER

FM TUNER MODEL FM-80

World's Best by I. R. E. Standards

NEVER before in the history of Frequency Modulation has there been a tuner to match the remarkable, new FISHER FM-80. Equipped with TWO meters, it will outperform any existing FM tuner, *regardless of price!* The FM-80 combines extreme sensitivity, flexibility, and micro-accurate tuning. It has an unusually *compact*, beautifully designed chassis. Like its renowned companions, the FISHER FM-AM Tuners, Models 50-R and 70-RT, we predict the FM-80 will be widely imitated, but never equalled. Be sure; buy THE FISHER. **Only \$139.50**

Outstanding Features of THE FISHER FM-80

- TWO meters; one to indicate sensitivity, one to indicate center-of-channel for micro-accurate tuning. • Armstrong system, with two IF stages, dual limiters and a cascode RF stage. • Full limiting even on signals as weak as one microvolt. • Dual antenna inputs: 72 ohms and 300 ohms balanced (*exclusive!*) • Sensitivity: 1½ microvolts for 20 db of quieting on 72-ohm input; 3 microvolts for 20 db of quieting on 300-ohm input. • Chassis *completely* shielded and shock-mounted, including tuning condenser, to eliminate microphonics, and noise from otherwise accumulated dust. • Three controls — Variable AFC/Line-Switch, Sensitivity, and Station Selector PLUS an exclusive Output Level Control. • Two bridged outputs. Low-impedance, cathode-follower type, permitting output leads up to 200 feet. • 11 tubes. • Dipole antenna supplied. Beautiful, brushed-brass front panel. • Self-powered. • WEIGHT: 15 pounds. • SIZE: 12¾" wide, 4" high, 8⅛" deep including control knobs.

Price Slightly Higher West of the Rockies

WRITE TODAY FOR COMPLETE SPECIFICATIONS

FISHER RADIO CORP. • 21-23 44th DRIVE • L. I. CITY 1, N. Y.

primary at the ripple frequency. Depending on the balance of the output tubes and the halves of the primary winding of the transformer, ripple voltages may appear across the secondary winding. There is therefore a good likelihood that feedback from the primary may increase rather than reduce the hum in the output. In any case it is undesirable to have these ripple voltages inserted into the early stages of an amplifier through the feedback loop.

When feedback is taken from both plates it must be very carefully balanced, and if it is taken over more than one stage the balance of the drive to the two output tubes is dependent upon the balance of the driver stages. If it is applied from plate to grid of the output tubes, any unbalance of characteristics of the driver stages is multiplied by the feedback system. For further

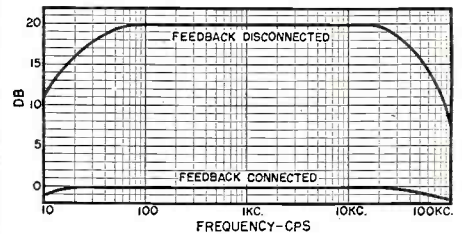

Fig. 13. Frequency response with amplifier operated with only one output tube with the output terminals open-circuited. This was done to demonstrate stability of unit.

disadvantages of balanced feedback the reader is referred to discussions by Good² and the author².

Another disadvantage of local feedback around the output stage is that it requires that a more complicated driving system be used, and this, in turn, leads to instability when a large amount of over-all feedback is used. A large amount of local feedback will not necessarily obviate the necessity for a large amount of over-all feedback since—especially at the lower frequencies—much of the distortion may be contributed by the output transformer, in which case primary feedback is not nearly as effective in reducing the distortion in the output as is secondary feedback.

As they say in the automobile in-

Fig. 14. Intermodulation distortion produced by amplifier using 40 cps and 7000 cps with ratio of 4:1. See text for full details.

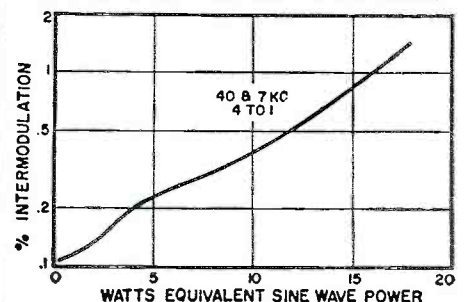

dustry, "what you don't put on doesn't cause you any trouble." So unless a feature buys improved performance it isn't advantageous to have it. The information presented in this article should convince the reader that it isn't necessary to have a super-complicated circuit to get good results. Why not have high-fidelity the easy way?

REFERENCES

1. Kiebert: "System Design Factors for Audio Amplifiers," IRE Convention Record, Part 6, 1954
2. Good: "Backtalk," Electronics, Oct. 1952
3. Bernard: "Backtalk," Electronics, Jan., 1954.

-30-

Flyback-Yoke Checker

(Continued from page 74)

put signal to the 6K6 grid to produce oscillations. The frequency of these oscillations depends upon the inductance of the secondary of T_2 , the capacity of C_1 and the time constant of the divider network consisting of C_2 , R_1 , R_2 and R_3 .

As a result, with the test input terminals open, the normal operating frequency is 600 cycles per second. During oscillation, a negative bias is developed across R_1 by virtue of the fact that the grid draws current. It is this voltage which is measured by the voltmeter circuit consisting of R_2 , R_3 , and the 0-50 microammeter.

To analyze the test operation, note that when S_2 , the function switch, is in the "Continuity" position, the test (input) terminals are placed between grid and ground. With the test terminals open, R_2 is adjusted for approximately 80% of full scale reading. When a resistance is connected across the terminals, it shunts the meter circuit and draws current, thus causing the meter to dip into the "Good" portion of the scale. An open circuit or extremely high resistance will cause the meter needle to remain stationary or dip slightly within the "Bad" portion of the scale.

In testing for shorted turns, S_2 is placed in the "Short" position and the test jacks are now shunted across the secondary of T_2 . If an inductance—air

Fig. 3. Schematic diagram of the flyback transformer and yoke tester described in detail in the article. The circuit is here shown set up for continuity tests.

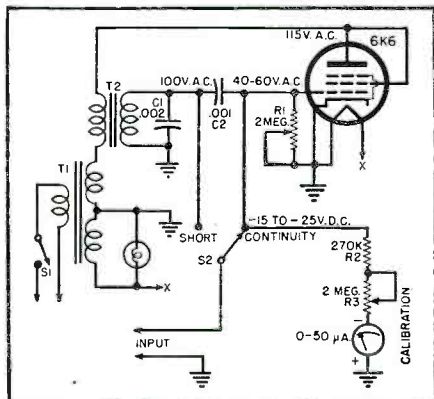

January, 1955

WE ARE PROUD TO ANNOUNCE

The Greatest Advance

IN AMPLIFIER DESIGN
IN TWENTY YEARS!

FISHER Z-MATIC

PAT. PEND.

THE unusual, the choice—both are a regular and traditional product of our engineering laboratories. But never before have we offered a technological advance so obviously needed, so long overdue, as the exclusive FISHER Z-Matic. Regardless of the speaker system, be it a modest 8" unit or a giant assembly, the vast acoustic improvement contributed by FISHER Z-Matic is instantly apparent and truly astonishing. For Z-Matic has at one stroke eliminated the energy-wasting, distortion-producing mismatch that has prevented the *complete* union of speaker and amplifier ever since the advent of electronic sound reproduction. Z-Matic is now standard equipment on all FISHER amplifiers.



50-Watt Amplifier • Model 50-AZ

100 watts peak! World's finest all-triode amplifier. Uniform within 1 db. 5 to 100,000 cycles. Less than 1% distortion at 50 watts. Hum and noise 96 db below full output. Oversize, quality components and finest workmanship. \$159.50

What Z-Matic Does

- Multiplies the efficiency and effective audible range of *any* speaker system, regardless of size.
- The continuously variable Z-Matic control permits any setting, according to personal taste or the requirements of the speaker system.
- Eliminates need for oversize speaker enclosures and *automatically* corrects inherent deficiencies in speaker or speaker housing.
- Z-Matic must *not* be confused with tone, equalization, loudness balance or damping factor controls. It is an entirely new development.
- Only FISHER amplifiers have Z-Matic.

A Word to Our Patrons

Your FISHER 50-A or 70-A amplifier can be readily equipped with Z-Matic. A complete kit of parts and easy-to-follow instructions are available at a cost of only \$2.50 to cover handling. Give serial number and model.

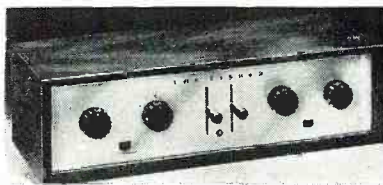

Master Audio Control • Series 50-C

"Finest unit yet offered." — *Radio and TV News*. 25 choices of record equalization, separate bass and treble tone controls, loudness balance control. 5 inputs and 5 independent input level controls, two cathode follower outputs. Chassis, \$89.50 • With cabinet, \$97.50

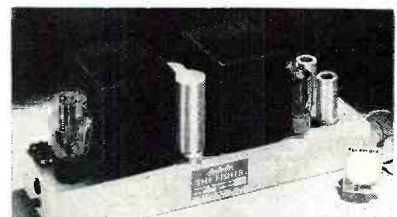

25-Watt Amplifier • Model 70-AZ

50-watts peak! More *clean* watts per dollar. Less than 1/2% distortion at 25 watts (0.05% at 10 watts.) Response within 0.1 db. 20-20,000 cycles; 1 db. 10 to 50,000 cycles. Hum and noise virtually non-measurable! \$99.50

Prices Slightly Higher West of the Rockies

WRITE TODAY FOR COMPLETE SPECIFICATIONS

FISHER RADIO CORP. • 21-23 44th DRIVE • L. I. CITY 1, N. Y.

Fine Additions

TO COMPLETE YOUR
HOME MUSIC SYSTEM

FISHER ACCESSORIES



MIXER-FADER • Model 50-M

NEW! Electronic mixing or fading of any two signal sources (such as microphone, phono, radio, etc.) No insertion loss. Extremely low hum and noise level. High impedance input; cathode follower output. 12AX7 tube. Self-powered. Beautiful plastic cabinet. **Only \$19.95**

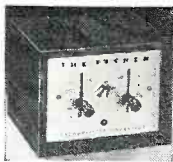

PREAMPLIFIER-EQUALIZER • 50-PR

Professional phono equalization. Separate switches for HF roll-off and LF turn-over; 16 combinations. Handles any magnetic cartridge. Extremely low hum. Uniform response, 20 to 20,000 cycles. Two triode stages. Fully shielded. Beautiful cabinet. Self-powered. **\$22.95**

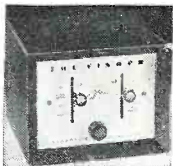

PREAMPLIFIER-EQUALIZER • 50-PR-C WITH VOLUME CONTROL

50-PR-C. This unit is identical to the 50-PR but is equipped with a volume control to eliminate the need for a separate audio control chassis. It can be connected directly to a basic power amplifier and is perfect for a high quality phonograph at the lowest possible cost. **\$23.95**

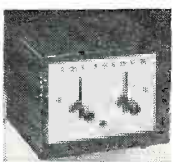

HI-LO FILTER SYSTEM • Model 50-F

Electronic, sharp cut-off filter system for suppression of turntable rumble, record scratch and high frequency distortion — with absolute minimum loss of tonal range. Independent switches for high and low frequency cut-off. Use with any tuner, amplifier, etc. **\$29.95**



PREAMPLIFIER • Model PR-5

A self-powered unit of excellent quality, yet moderate cost. Can be used with any low-level magnetic cartridge, or as a microphone preamplifier. Two triode stages. High gain. Exclusive feedback circuit permits long output leads. Fully shielded. Uniform response, 20 to 20,000 cycles. **\$12.57**

FLASH!

At the historic High Fidelity Concert given by the National Symphony Orchestra in Constitution Hall, November 13th, 1954, FISHER 50-AZ Amplifiers and a FISHER Master Audio Control were used to play back the tape recordings made on the spot for the thrilled audience.

Prices Slightly Higher West of the Rockies

WRITE TODAY FOR COMPLETE SPECIFICATIONS

FISHER RADIO CORP. • 21-23 44th DRIVE • L. I. CITY 1, N. Y.

core or iron core, is placed across the test terminals, there should be no effect upon the operation of the oscillator other than to increase the frequency of oscillations. This is precisely the condition which occurs if the coil under test has no shorted turns. The meter reading will remain stationary or dip slightly within the "Good" portion of the scale, depending upon the a.c. impedance of the unit under test. This follows because we know that a good coil will not absorb energy from the oscillator but will, instead, return its stored energy to the oscillator on alternate half cycles.

If shorted turns are present, they will act as a secondary winding with low load resistance and draw substantial current from the oscillator circuit. This will leave less current in the grid circuit and, therefore, the negative bias on the grid will decrease. Since the meter is measuring the grid bias, it will read a lower value and dip into the "Bad" portion of the scale.

The fact that a shorted turn(s) acts as a secondary with low load resistance coupled to the other windings of a transformer, makes it possible to test a transformer with any number of windings simply by checking any one of the individual windings. —30—

GEIGER COUNTER FLASHER

By MARCUS E. WEST, W4SMN

THOSE who built the geiger counter described in the article "A Simple Geiger Counter" (July 1954 RADIO & TELEVISION NEWS) may want to go one step further and add a neon flasher. The flasher will give a visual indication of the presence of alpha or gamma rays so one can see as well as hear their presence.

The neon flasher can be added with very little trouble and few parts. After a little experimentation it was found that a 6V6 push-pull output transformer worked very well as an autotransformer when the primary was connected as shown in the accompanying diagram. The secondary or voice coil leads were cut off close to the transformer. The center tap lead was used as the "B+" connection and one of the remaining leads as the connection for the plate of the 1S4 tube. The NE51 neon bulb was connected across the full transformer primary.

The only change that was made in the original circuit was to install a 45-volt battery in place of the 22½-volt unit originally specified. This was done in order to produce a brighter flash in the neon bulb. —30—

Neon flasher unit that can be added to the Geiger counter circuit in July 1954 issue.

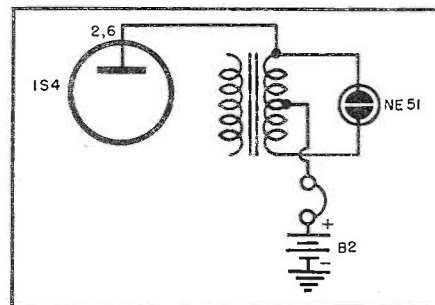

Feedback Systems

(Continued from page 58)

gives the desired low-frequency phase reversal in the feedback.

The performance of this circuit may be seen from the data given in Table 1 and the curves in Fig. 7. The harmonic distortion data shows a maximum third harmonic at 1000 cps, at 8 watts output into a 3.9 ohm loudspeaker load, of 0.32%; and at 400 cps of 0.24%. Higher harmonics in the output are negligible. A comparison of the harmonic distortion and the intermodulation distortion under conditions of no feedback, negative feedback alone, and combined positive-negative feedback, shows the considerable improvement which results from the addition of the positive feedback to the circuit. The output voltage regulation is 0.1 db at 400 cps, as compared with 2.7 db with negative feedback alone, or 19 db with no feedback.

Another simple method of including positive feedback in an amplifier is shown in Fig. 8, which shows both the negative and the positive feedback taken from the secondary of the output transformer. When the output transformer is properly phased and connected for negative feedback, the addition of the small resistor between the transformer secondary and ground will introduce positive current feedback into the system. This positive current feedback reduces the output impedance to improve the damping in the loudspeaker circuit. However, in this type of circuit the positive feedback loop includes the output stage in which the major part of the distortion originates, therefore the distortion increases with the application of the positive feedback. However, the use of the negative feedback will keep the over-all distortion within acceptable limits.

The use of positive and negative feedback as described in this article will result in a decided improvement in the electroacoustic characteristics of the sound reproducing system. However, a certain amount of caution must be exercised in its use. The most important factor to be considered is that the stability margin in the amplifier is reduced, and oscillations are therefore more likely to occur. The experimenter should, therefore, ac-

Fig. 8. A simple and convenient method for applying combined positive-negative feedback from secondary of output transformer.

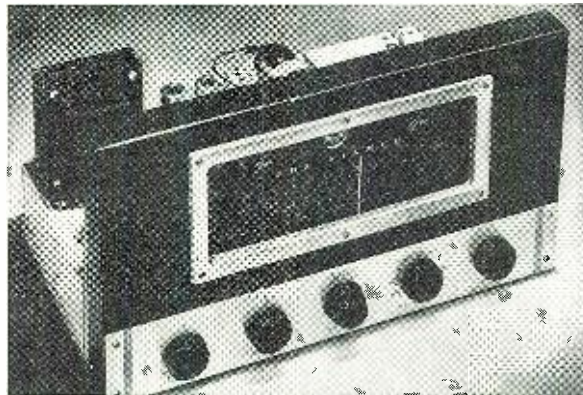
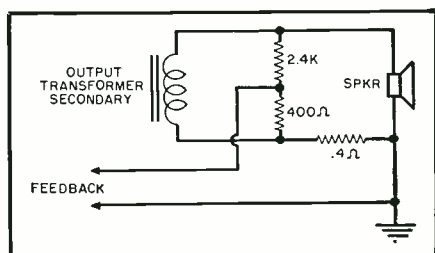

MODEL 70-RT

World's Finest

BY I. R. E.
STANDARDS

FISHER

Professional

FM-AM TUNERS

THE truest index to the quality of FISHER Tuners is the roster of its exacting users. An Eastern FM station chose the FISHER to pick up selected New York and Washington programs *direct*, for rebroadcast to its own community. Reception of FM stations over 150 miles distant, terrain permitting, is a regular occurrence, if you own a FISHER Professional FM-AM Tuner, 70-RT or 50-R.

MODEL 70-RT

■ Features *extreme sensitivity* (1.5 mv for 20 db of quieting); works where others fail. Armstrong system, *adjustable AFC* on switch, *adjustable AM selectivity*, separate FM and AM front ends. Complete shielding and shock-mounting on main and subchassis. Distortion below 0.04% for 1 volt output. Hum level: better than 90 db below 2 volts output on radio, better than 62 db below output with 10 mv input on phono. Two inputs. Two cathode follower outputs. Self-powered. Exceptional phono preamplifier with enough gain for even lowest-level magnetic pickup. Full, phono equalization facilities. 15 tubes. Six controls, including Bass, Treble, Volume, Channel/Phono-Equalization, Tuning and Loudness Balance. Beautiful Control Panel. SIZE: 14¾" wide, 8½" high, 9¼" deep.

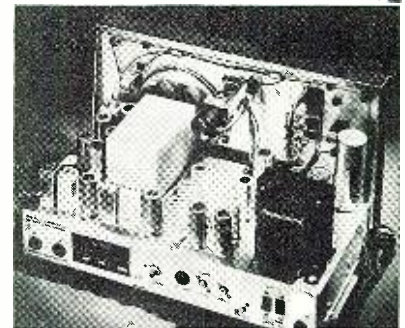

MASTERPIECE OF TUNER DESIGN

MODEL 50-R

■ Identical to the 70-RT but designed for use with an *external* preamplifier-equalizer, such as the FISHER Series 50-C.

MODEL 50-R

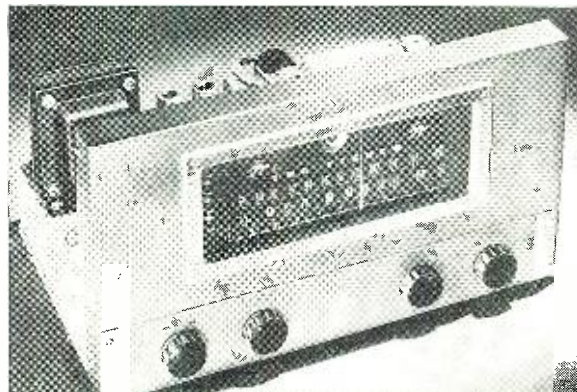

MODEL 70-RT

\$184.50

MODEL 50-R

\$164.50

PRICES SLIGHTLY HIGHER
WEST OF THE ROCKIES

Write for Full Details

FISHER RADIO CORP.

21-23 44th DRIVE
LONG ISLAND CITY 1, N. Y.

Become an
ELECTRICAL ENGINEER

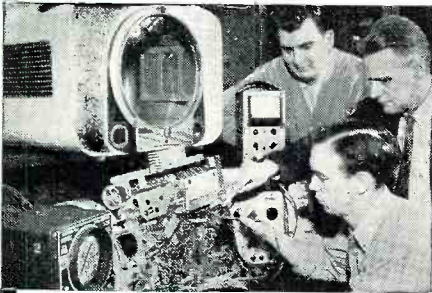

**Major in Electronics or Power
BS Degree in 36 months**

Prepare now for a career as an electrical engineer or engineering technician — and take advantage of the many opportunities in these expanding fields.

You can save a year by optional year 'round study. Previous military, academic, or practical training may be evaluated for advanced credit.

**Enter Radio and Television
— courses 12 to 18 months**

You can be a radio technician in 12 months. In an additional 6-months you can become a radio-television technician with Associate in Applied Science degree. Color television instruction is included in this program.

These technician courses may form the first third of the program leading to a degree in Electrical Engineering. Twenty-one subjects in electronics, electronic engineering and electronic design are included in these courses.

Courses also offered: radio-television service (12 mos.); electrical service (6 mos.); general preparatory (3 mos.).

Terms—April, July, September, January

Faculty of specialists. 50,000 former students—annual enrollment from 48 states, 23 foreign countries. Non-profit institution. 52nd year. Courses approved for veterans. Residence courses only.

MS-6A

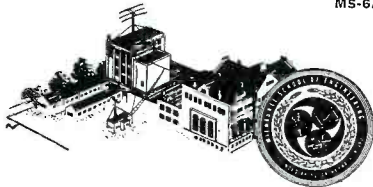

**MILWAUKEE
SCHOOL OF ENGINEERING**

MILWAUKEE SCHOOL OF ENGINEERING
Dept. RT-153, 1025 N. Milwaukee Street
Milwaukee 1, Wisconsin

Send FREE illustrated booklets
 Career in Electrical Engineering,
 Career in Radio-Television.

I am interested in _____
(name of course)

Name _____ Age _____

Address _____

City _____ Zone _____ State _____

If veteran, indicate date of discharge _____

quire some experience with negative feedback alone in amplifiers (for example, the application of 20 db of negative feedback around three amplifier stages and the output transformer) before beginning to experiment with combined positive and negative feedback.

Testing of the system, to assure the proper amount of positive feedback for optimum damping in the loudspeaker circuit, requires an acoustic method of testing, since the effects of the damping appear in the sound output of the loudspeaker. Such a test generally requires a sound standard microphone, and should be performed in an acoustically treated room neither of which are generally included in the

equipment of the average audio experimenter. The simplest method of testing for optimum damping is to use the ear as the test instrument, by listening to the sound from the loudspeaker, and adjusting the amount of positive feedback to give the best sound quality. When the damping is adjusted, there may be an apparent lack of lows in the sound output, since some of the bass in many systems results from spurious cone motion due to underdamping. When the system is properly damped, there is a decided increase in clean and crisp sound, resulting in considerably increased listening pleasure and an absence of fatigue even after long periods of listening. —30—

CONVERTING 33 1/3 RPM MOTORS TO 45 RPM

By ARTHUR TRAUFFER

WHEN Columbia came out with their LP microgroove records, many 33 1/3 rpm record-players were manufactured and sold to accommodate the new records. However, many owners of these LP players would like to convert to 45 rpm to take advantage of these newer records. Single 45 rpm records cost less and they can be stored in a smaller space. Also, some like to take advantage of the "five-for-a-dollar" second-hand 45 rpm "juke box" records which are sold here and there.

The writer has converted several LP players to 45 rpm by simply slipping a small metal spring over the motor shaft to raise the speed of the idler wheel and turntable. Fig. 1 shows the motor shaft and idler wheel of a typical 33 1/3 rpm phono motor while Fig. 2 shows the same motor with a spring on the shaft which gave the turntable a speed of 45 rpm. If you have trouble locating a small spring of the right size and thickness for your phono motor shaft, you can wind your own from bare solid

copper wire. You will have to try different gauges of wire until you have a spring of the right thickness to bring you close to 45 rpm.

Wind the spring around a metal rod or piece of wire which is slightly smaller in diameter than the motor shaft; this is done because the coil will spring to a slightly larger diameter when it is removed from the form, and you want to be sure that the spring makes a snug fit on the motor shaft.

When you clip off the two ends of the spring, be sure the spring is long enough so that the two sharp wire ends will clear the rubber tire on the idler wheel, but the spring should not be long enough to rub on the bottom of the turntable. If the spring is just a half a hair too large in diameter, you can shave it down with emery cloth while it is rotating, until you hit 45 rpm on the nose. Better to have the turntable turn a little too fast than too slow. If you want to go back to 33 1/3 rpm again, simply pull off the spring! —30—

Fig. 1. Enlarged view of the motor shaft and idler wheel of a typical 33 1/3 rpm record-player motor. See text for details on how author converted unit for 45 rpm.



Fig. 2. Same motor as Fig. 1 with a copper wire coil spring slipped onto shaft to raise turntable speed to 45 rpm. Thickness of spring wall prevents turntable "wow".



NEW 1955

Heathkit

Engineering Features

New PRINTED CIRCUITS

One of the many tremendous improvements in the new 1955 Heathkits is the use of an etched metal process printed circuit board. Printed circuits will be used in Heathkits whenever they will affect construction simplification, performance stabilization, and lend themselves to instrument design. Now for the first time a kit instrument company offers the advantages of modern printed-circuit instrument construction technique. For the first time consideration has been given toward reducing kit assembly time. Also this is the first time that printed circuit boards have been hand soldered on a volume basis. Offered only by Heathkit, the pioneer and leader in kit instrument design.

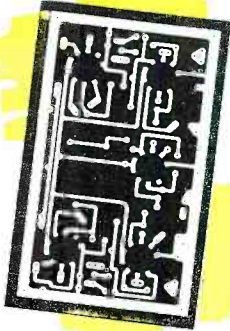

New PEAK-TO-PEAK VTVM CIRCUIT

New 6AL5 full wave rectifier in AC input circuit permits full scale peak-to-peak measurements. Seven ranges — upper limits 4000 volts peak-to-peak. Just the thing you TV servicemen have needed in making TV circuit voltage checks. Precision resistor voltage divider limits AC RMS level to 150 volts. Prevents overloading the rectifier — extends upper limit AC RMS ranges to 1500 volts — further protects meter and circuitry against AC flash-over or arcing. Another definite example of continuing Heathkit design leadership in the kit instrument field.

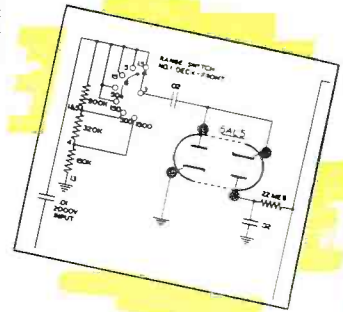

New HIGH READABILITY PANELS

New 1955 Heathkits feature complete panel redesign. Sharp white lettering applied to the beautiful charcoal gray panels, provide a new high in readability. Lettering is easy-to-read open style and panel calibrations are vividly clear against the pleasing soft gray background. New knobs of exclusive Heathkit design.



New 3" UTILITY SCOPE

The new 3" Scope is a "natural" for the well rounded line of Heathkit instruments. Small in size, 11 3/4" deep, 6 1/2" wide, 9 1/2" high, yet big in performance. Just think of the value an Oscilloscope for \$29.50. Brilliant intensity, sharp focusing, wide positioning range. An ideal portable Scope for the TV serviceman — a second shop scope — modulation monitor for you hams (deflection plate terminals in rear of cabinet). Performance to spare for all general scope applications. See specifications on following page.



New STYLING New COLOR

New styling and coloring is responsible for tremendous improvement in Heathkit appearance. The new instrument panel color combination is high definition white lettering in a soft charcoal gray panel. Cabinet color is a lighter leather gray. The satin gold baked enamel cabinet for the WA-P2 Preamplifier is further indicative of the modern parasetting trend in Heathkit styling.



New SCOPE SWEEP CIRCUIT 10 CYCLES — 500 KC

New 1955 Heathkit Model 0-10 Scope features a new wide frequency range generator covering 10 cycles to 500,000 cycles. This coverage is available in five virtually decade sweep ranges and is five times greater than the sweep ranges usually available. Excellent retrace time characteristics, actually less than 20% at 500 KC. Use of the free running Heath circuit provides a larger margin of stability and a new high in Heathkit Scope performance.

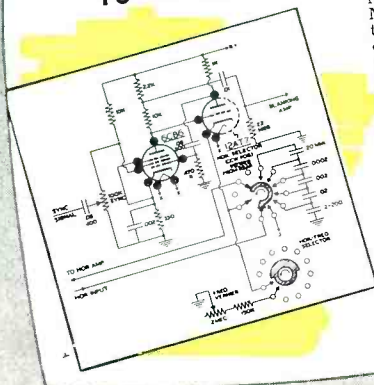

Continuing PROGRESS FUTURE LINE EXPANSION

The outstanding improvements featured in the 1955 Heathkit line are representative of the progress characterized by the Heath Company operation. Long range planning will provide a continuing succession of new kit releases to further expand the Heathkit line which already represents the world's greatest selection of electronic kits. The innovations in the 1955 line, are representative of additional new models scheduled for release for the coming years.



SEE THE INSTRUMENTS
ON THE FOLLOWING PAGES

HEATH COMPANY • Benton Harbor 15, Mich.

Heathkit ELECTRONIC SWITCH KIT

The basic function of the Heathkit Electronic Switch Kit is to permit simultaneous oscilloscope observation of two separate traces which can be either separated or superimposed for individual study. This is accomplished through the use of two individually controlled inputs working through amplifier, multi-vibrator, and blocking stages. The output of the Electronic Switch is connected directly to the vertical input of the Oscilloscope. A typical example of usefulness would be simultaneous observation of a signal or waveform as it appears at both the input and output stages of an amplifier.

APPLICATIONS

An Electronic Switch has many applications to increase the over-all operating versatility of your oscilloscope. It can be used to check amplifier distortion—audio crossover networks—phase inverter circuits—to measure phase shift—special waveform study, etc. The instrument can also be conveniently used as a square wave generator over the range of switching frequencies, often providing the necessary wave form response information without incurring the expense of an additional instrument. Ownership of this instrument will reveal many entirely new fields of oscilloscope application and will quickly justify the modest cost of the Electronic Switch Kit.

Tube complement:
2—6X4, 1—6X6,
1—6AV6

Continuously variable
switching rates in three
ranges from less than 10
CPS to over 2000 CPS.

Individual input
gain controls, po-
sition control,
coarse frequency
control, and fine
frequency control.

Transformer operated for
safety when used in con-
junction with other equip-



MODEL S-2

\$23.50

Shpg. Wt.
8 lbs.

Heathkit VOLTAGE CALIBRATOR KIT



MODEL VC-2

\$11.50

Shpg. Wt. 4 lbs.

Another useful oscilloscope accessory particularly in circuit development work and in TV and radio service work. The Voltage Calibrator provides a convenient method for making peak-to-peak voltage measurements with an oscilloscope, by establishing a relationship on a comparison basis between the amplitude of an unknown wave shape and a known output of the voltage calibrator. Peak-to-peak voltage values are read directly from a calibrated panel scale without recourse to involved calculations.

FEATURES:

To off-set line voltage supply irregularities, the instrument features a voltage regulator tube. A convenient "signal" position on the panel switch by-passes the calibrator completely and the signal is applied through the oscilloscope vertical input, thereby eliminating the necessity for constantly transferring test leads.

RANGES:

With the Heathkit Voltage Calibrator it is possible to measure all types of complex waveforms within a voltage range of .01 to 100 volts peak-to-peak. Build this instrument in a few hours and enjoy the added benefits offered only through combination use of test equipment.

Heathkit LOW CAPACITY PROBE KIT



No. 342

\$3.50

Shpg. Wt. 1 lb.

An oscilloscope accessory, the 342 Low Capacity Probe permits observation of complex TV waveforms without distortion. An adjustable trimmer provides proper matching to any conventional scope input circuit. Excellent for high frequency, high impedance, or broad bandwidth circuits. The attenuation ratio can be varied to meet individual requirements.

Heathkit SCOPE DEMODULATOR PROBE KIT



No. 337-C

\$3.50

Shpg. Wt. 1 lb.

Extend the usefulness of your oscilloscope by observing modulation envelopes of RF or IF carriers found in TV and radio receivers. The Heathkit Demodulator Probe will be helpful in alignment work, as a gain analyzer and a signal tracer. Easy construction with the new modern printed circuit board. Voltage limits are 30 volts RMS and 500 volts D.C.

HEATH company

BENTON HARBOR 15,
MICHIGAN

Mac's Service Shop (Continued from page 76)

had time to form an opinion by now, I suppose."

"I've formed several opinions about that experience," Mac said with a slow grin. "You'll recall I had a five-element channel 6 yagi at the very top of a ten-foot pipe mast, while a two-bay, twenty-element conical was mounted below this. The mast and antennas were rotated on top of a forty-two foot guyed aluminum tower. The whole thing was put up three years ago last July 4th and has never been touched since."

"Hey!" Barney said, "that won't do. A lot of the TV installers are telling their customers the feedlines should be replaced and the antennas cleaned every year."

Mac nodded. "I've been hearing that, too, and I was curious to see for myself in what condition I would find the antennas and feedlines. On top of that, though, the guy wires were getting pretty rusty-looking; and now that the station in Center City is putting in a pretty good signal, I was beginning to wonder if all that bird-roost was necessary up there in the air. The starlings seemed to think well of it, but the wife did not share their opinion."

"Were the guys right about the feedlines?" Barney pressed.

"Yes and no," Mac replied with a quizzical smile. "When I put up the tower, I used two different brands of flat feedline. Both looked equally good, and they cost the same amount; but when I laid the tower down in the yard, here is what I found: the line feeding the conical had cracked and crazed so badly that portions of the web were actually missing, allowing the conductors to assume various spacing. On the other hand, the line feeding the yagi looked just as good as the day I put it up. Rolling it between my fingers so that it was forced into an arc with a radius of one-eighth inch or less did not cause it to crack or show any change whatever. The web material was smooth, shiny, and live-looking. In short, I couldn't see a thing about this line that would impair its performance. Out of curiosity, I carefully cut sections of both lines from side-by-side positions on the mast and mailed a sample of each to the two manufacturers who had made them. I asked for comments concerning the cause of the deterioration in the one case and the measured efficiency of the sample in the other."

"What did they say?" Barney asked eagerly.

"The manufacturer of the line that had gone bad did not try to cover up in any way. He frankly explained that a few years back his supplier of web material had run short of a special antioxidant material necessary to prevent weathering and had substituted another antioxidant without saying anything about it and without making

RADIO & TELEVISION NEWS

NEW Heathkit 5" PUSH-PULL OSCILLOSCOPE KIT FOR COLOR TV

BRAND NEW DESIGN: The new Heathkit Model O-10 Oscilloscope would be something special at any price, but is almost unbelievable at \$69.50. Completely re-designed scope has broadband amplifiers for color TV work and offers brilliant overall performance. Vertical frequency response within 5 db from 5 cps to 5 mc. Even more astounding, the response is down less than 1 1/2 db at 3.58 mc, the color TV sync burst frequency. It is essential that scopes for color work have these broadband characteristics.

PRINTED CIRCUITS: Two printed circuit boards used in this fine instrument to insure stable, consistent performance. Problems solved by pre-engineering of boards, and their use guarantees completed unit that will have same characteristics as lab development model. Printed circuits simplify construction and save labor.

NEW SWEEP CIRCUIT: Sweep circuit operates with exceptionally good linearity from 20 cps to over 500,000 cps, 5 times the usual range for scopes in this price range. An entirely new circuit introduced for the first time in any Heathkit.

First color television service Oscilloscope with necessary high sensitivity and full 5 megacycle bandwidth.

New 5U1 CR tube

New printed circuit construction, all components mounted on high insulation surface resulting in unusually low circuit capacities.

New type wide frequency range Heath sweep generator, 10 cycles to 500,000

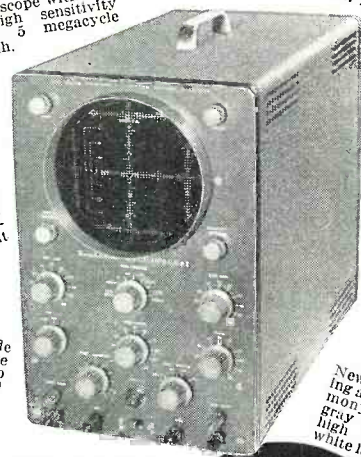

New electronic positioning controls for instantaneous, definite positioning without bounce or overshoot.

New cabinet styling and color harmony—charcoal gray panel with high readability white lettering.

MODEL O-10
\$69.50
Shpg. Wt. 27 lbs.

Simplified, standardized construction technique of vertical and horizontal amplifier construction made possible through the use of a single printed circuit board.

FEATURES: Other outstanding characteristics of this professional oscilloscope are: Built-in 1V peak-to-peak reference for calibration of plastic CRT face-plate; 5" 5U1 CRT; push-pull hor. and vert. deflection amplifiers; hor. trace width expandable to 3 times diameter of CR tube to allow inspection of any small portion of the signal; deflection sensitivity, .025 volts per inch; wiring harness pre-formed and cabled to save construction time and insure professional appearance and operation. Incorporates efficient retrace blanking. Frequency compensated step attenuator at the vertical input. Entire tube face usable. No foldover on vertical over-load. Performance obtainable only in much more expensive laboratory models.

Uses 5U1, 6AB4, 6B07, 12BH7, 6CB6, 12AT7, 2-12AU7, 6X4, 1V2, and 6C4. Quality components used throughout so that outstanding performance characteristics may be maintained for years to come. Plastic molded condensers are used in all coupling and by-pass applications. The "new-look" in Heathkit styling produces professional appearance in keeping with the professional performance of this instrument.

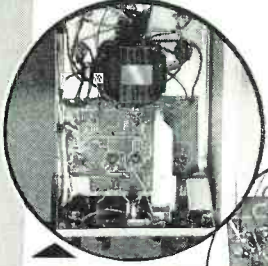

Clean, open, under chassis construction and wiring. Possible only through use of pre-cabled wiring harness, and simplified printed circuit boards.

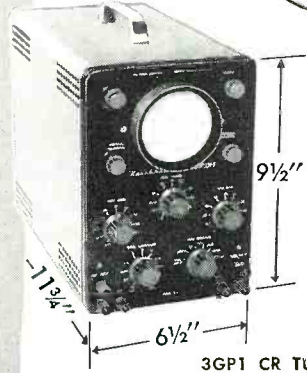
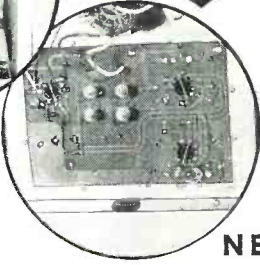

NEW Heathkit
3" PRINTED CIRCUIT
OSCILLOSCOPE KIT
MODEL OL-1
\$29.50 Shpg. Wt. 15 lbs.

New easy-to-build printed circuit board with high insulation factor.
New Heathkit instrument styling—charcoal gray panel with high readability white lettering.
New Heath twin triode sweep generator 15-100,000 cycle sweep.

New compact utility Scope—light-weight—portable for service work.
Deflection plate terminals—ideal for ham transmitter modulation monitoring.

EXCEPTIONAL VALUE: The brand new Model OL-1 Utility Oscilloscope is designed especially for portable applications so that outside servicemen or persons performing field tests can have the advantages of a scope available. Then too, it is ideal for home workshop, the ham-shack, or as an "extra" scope for the service shop. It is compact, light in weight, and surprisingly versatile in operation. An outstanding instrument for the price.

Front panel controls are "bench-tested" for ease of operation and convenience. Printed circuit board used for constant circuit performance. Assembly time cut in half!

SPECIFICATIONS: Vertical amplifiers feature frequency response within 1 db from 10 cps to 100 kc, and within 5 db from 5 cps to 500 kc. Vertical sensitivity .2 volts per inch at 1 kc, with input impedance of 12 mμfd shunting 10 megohms.
Horizontal response within 1 db from 10 cps to 200 kc, and within 5 db from 5 cps to 500 kc. Hor. sensitivity .25 volts per inch at 1 kc, input impedance of 15 mμfd shunting 10 megohms. Sweep generator covers 10 cps to 100,000 cps with stable positive lock-in circuit. Cathode follower input in both vert. and hor. amplifiers; push-pull vertical and horizontal deflection amplifiers; 3" CRT; electronic positioning controls for wide range of vertical and horizontal spot deflection; provision for internal and external sync; 60 cycle line sweep. New modern color styling and unusual performance make this instrument an outstanding value.

NEW Heathkit
5" PRINTED CIRCUIT
OSCILLOSCOPE KIT
MODEL OM-1
\$39.50 Shpg. Wt. 24 lbs.

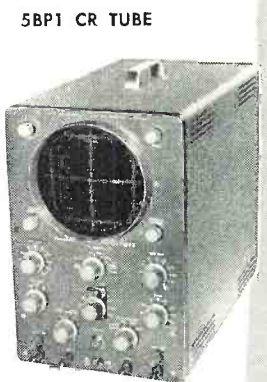

VERSATILE INSTRUMENT: The new Model OM-1 general purpose Oscilloscope represents an outstanding dollar value in reliable test equipment. Full 5 inch CRT. Printed circuit boards for ease of assembly, constant circuit characteristics, and rugged component mounting. Includes all the design features necessary for servicemen, students, experimenters, radio amateurs, etc. Frequency response of amplifiers flat within 1 db from 10 cps to 100 kc, and down only 7 db from 10 cps to 500 kc. Sweep generator range from 20 cps to 100,000 cps. Also features new Heathkit color styling with charcoal gray panel and high definition white lettering for readability even under subdued lighting conditions.

DESIGN FEATURES: A full-size, versatile oscilloscope at a price you can afford. Other features are: adjustable spot shape control; RF connections to deflection plates; direct coupled centering controls; external and internal sweep and sync; 60 cycle line sync; built in 1 volt peak-to-peak panel terminal reference voltage; professional appearance of cabinet, panel, and knob styling.

HEATH company
BENTON HARBOR 15,
MICHIGAN

Heathkit MULTIMETER KIT

The new Heathkit Multimeter is a "must" to complete the instrument lineup of any well equipped service shop. Here is an instrument packed with every desirable service feature, many of which are not found in other Multimeters. All of the measurement ranges you need or want. High sensitivity 20,000 ohms per volt DC; 5,000 ohms per volt AC.

★ ADVANTAGES

Complete portability through freedom from AC line power operation—provides service ranges of direct current measurements from 150 microamps up to 15 amperes—can be safely operated in RF fields without impairing accuracy of measurement.

★ RANGES

Full scale AC and DC voltage ranges are 0-1.5, 5, 50, 150, 500, 1500 and 5,000 volts. Direct current ranges are 150 microamps, 15, 150 and 500 milliamperes and 15 amperes. Resistances are measured from .2 ohms to 20 megohms in 3 ranges and db range from -10 to +65 db.

★ CONSTRUCTION

The Heathkit MM-1 features a unique resistor ring switch mounting assembly procedure. With this method of assembly the precision resistors are wired to the rings and range switch before actual mounting of the switch to the instrument panel. This procedure affords the advantage of simpler construction yet complete accessibility of precision resistors in event replacement is ever required. Ohmmeter batteries were selected for convenience of replacement and only standard commercially available types are used. Batteries consist of 1 type C flashlight cell and 4 Penlite cells. All batteries and necessary test leads are furnished with the kit.

All 1% precision multipliers—resistors—microamp $4\frac{1}{2}$ " Simpson meter.

Total of 35 meter ranges on two color scale.

New modern cabinet styling—attractive appearance.



Polarity reversal switch eliminates transferring of test leads.

20,000 ohms per volt sensitivity DC; 5,000 ohms per volt AC.

MODEL MM-1

\$26⁵⁰

Shpg. Wt. 6 lbs

Heathkit HANDITESTER KIT



MODEL M-1

\$14⁵⁰

Shpg. Wt. 3 lbs.

The Heathkit Model M-1 Handitester readily fulfills major requirements for a compact, portable volt-ohm milliammeter. The small size of the smooth gleaming molded bakelite case permits the instrument to be tucked into your coat pocket, toolbox or glove compartment of your car. Always the "Handitester" for those simple repair jobs.

RANGES:

Despite its compact size, the Handitester is packed with every desirable feature required in an instrument of this type. AC or DC voltage ranges, full scale, 10, 30, 300, 1,000 and 5,000 volts. 2 convenient ohmmeter ranges 0-3,000 ohms and 0-300,000 ohms. 2 DC milliammeter ranges 0-10 milliamperes and 0-100 milliamperes.

CONSTRUCTION

The instrument uses a 400 microampere meter movement which is shunted with resistors to provide a uniform 1 milliampere load in both AC and DC ranges. This design allows the use of but 1 set of 1% precision divider resistors on both AC and DC and provides a simplicity of switching. A small hearing aid type ohms adjust control provides the necessary zero adjust function on the ohmmeter range. The AC rectifier circuit uses a high quality Bradley rectifier and a dual half wave hookup. Necessary test leads and battery are included in the price of this popular kit.

Heathkit RESISTANCE SUBSTITUTION BOX KIT

MODEL RS-1

\$5⁵⁰



Shpg. Wt. 2 lbs.

36 standard RTMA 1 watt resistor values between 15 ohms and 10 megohms with an accuracy of 10% are at your fingertips in the Model RS-1 Resistance Substitution Box kit. This sturdy and attractive accessory will easily prove its worth many times over as a time saving device. Order several today.

Heathkit CONDENSER SUBSTITUTION BOX KIT

MODEL CS-1



\$5⁵⁰

Shpg. Wt. 2 lbs.

18 standard RTMA values are available from .0001 mfd to .22 mfd. An 18 position switch set in the panel of an attractive bakelite case allows quick changes without touching the test leads. Invest a few minutes of your time now and save hours of work later on.

HEATH company

BENTON HARBOR 15,
MICHIGAN

sufficient tests. The result was that the line produced with this material weathered very badly. As soon as the situation was discovered, the company immediately stopped using the material, but not before many thousands of feet of it were already in use, causing great embarrassment and chagrin to the company.

"The manufacturer of the line that seemed to be in good condition reported it was just as good as it looked. Careful examination in the laboratory revealed absolutely no trace of deterioration. The only thing found was an insignificant amount of soot."

"Then it looks as though you can depend upon a good feedline to stay good for at least three years," Barney concluded.

"Whoa, now!" Mac cautioned. "Let's not jump to conclusions. All we actually know is that *at my location* this particular line would be good for at least three years and that changing it in less time than that would be a waste of money. You must remember, though, that we have no salt spray and little smoke or fog to contend with here. Most of the houses in my block are heated with gas. Along the ocean or in a heavily industrialized area or in some other spots with unusual conditions, it might well be necessary to change the feedline once a year."

"What shape were the antennas in?"

"In general, they were in good condition. There were no loose elements, and the small deposit of soot on the insulators was unimportant when you consider it was actually in parallel with an impedance of 300 ohms. The steel booms of the conical were beginning to rust pretty badly. While this detracted from the appearance, I cannot see how it could impair performance. By the same token any corrosion that interferes with a proper electrical contact between the various elements of an antenna may easily interfere with its operation, but I greatly doubt that a corrosive coating on the surface of an antenna element makes a measureable amount of difference. In other words, I do not believe such corrosion acts as an 'insulator' serving, as some technicians seem to think, to prevent the signal from reaching the antenna. I am convinced my all-aluminum yagi was performing just as well on the day I took it down as on the day I put it up, in spite of the fact that it no longer glistened brightly in the sun as it did at first.

"Incidentally, I might mention that the use of brass bolts is not sufficient insurance against corrosion. Most of these broke in two when we attempted to unscrew nuts from them. All bolts, connections, and so on in the new installation were given a good shot of plastic spray."

"What kind of an antenna did you actually put up?"

"I decided to try one of the new 'all-band yagis,' as they are called. There are several different versions of this basic type. Keep in mind I was not attempting to put up a 'best' antenna.

RADIO & TELEVISION NEWS

NEW *Heathkit* VACUUM TUBE VOLTMETER KIT PRINTED CIRCUIT DESIGN

New charcoal gray baked enamel panel with high readability, white lettering, soft feather gray cabinet, subdued pilot light indicator.

New printed circuit board for faster, easier construction—exact duplication of Lab development model.

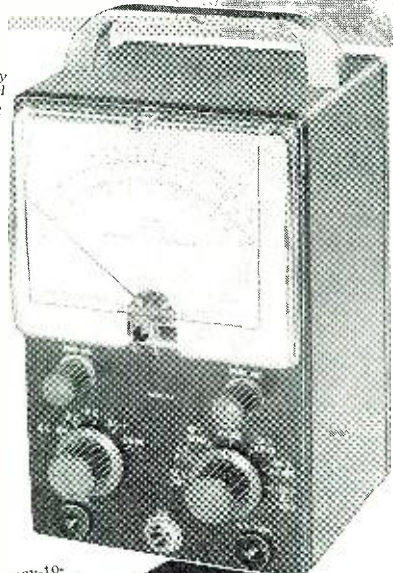

Another outstanding example of continuing Heath Company pioneering and leadership in the kit instrument field. A new **printed circuit** VTVM. New peak-to-peak circuit—new styling and new panel design. A prewired, prefabricated printed circuit board eliminates chassis wiring, cuts assembly time in half, assures duplication of Engineering pilot model specifications, and virtually eliminates possibility of construction error.

CIRCUIT:

A 6AL5 tube operated as a full wave AC input rectifier permits seven peak-to-peak voltage ranges with upper limits of 4000 volts P-P. Just the ticket for you TV servicemen. Voltage divider in the 6AL5 input circuit limits applied AC input to a safe level. This circuitry and the isolation of the meter in the cathode of the 12AU7 bridge circuit affords a high degree of protection to the sensitive 200 microampere meter.

RANGES:

Seven voltage ranges. 1.5, 5, 15, 50, 150, 500 and 1,500 volts DC and AC RMS. Peak-to-peak ranges 4, 14, 40, 140, 400, 1400, 4000. Ohmmeter ranges X1, X10, X100, X1000, X10K, X100K, X1 meg. Additional features are a db scale, a center scale zero position, and a polarity reversal switch.

IMPORTANT FEATURES:

High impedance 11 megohm input—transformer operated—1% precision resistors, 6AL5 and 12AU7 tube—selenium power rectifier—individual AC and DC calibrations—smoother improved zero adjust control action—new panel styling and color—new placement of pilot light—new positive contact battery mounting—new knobs—test leads included.

The new V-7 also sets the pace as a kit instrument style leader. Smart, good-looking charcoal gray panel and soft feather gray cabinet. High readability panel with sharply contrasting white calibrations. The pleasing, eye catching, modern styling is in harmonious balance with the outstanding circuit design improvements. Easily the best buy in kit instruments.

New easy-to-read open panel layout. On-on switch now incorporated in the selector switch.

MODEL V-7

\$24.50

Shpg. Wt. 7 lbs.

New peak-to-peak meter scale—new color harmony—new knobs.

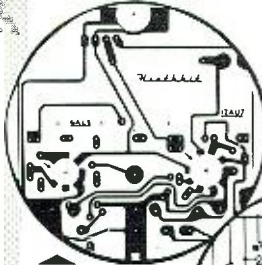

The first kit instrument to offer a labor-saving, error-free printed circuit board. Your instrument an exact wiring replica of Engineering development model.

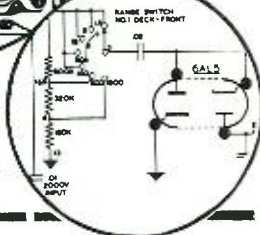

Heathkit AC VACUUM TUBE

VOLTMETER KIT MODEL AV-2

\$29.50

Shpg. Wt. 5 lbs.

Extreme sensitivity has been emphasized in the design of the Heathkit AC VTVM. Ten full scale RMS ranges are .01, .03, .1, .3, 1, 3, 10, 30, 100, and 300 volts. Frequency response is substantially flat from 10 cycles per second to 50 KC with input impedance of 1 megohm at 1 KC. Will accurately measure as low as 1 millivolt at high impedance. Total db range is -52 db to +52 db. An excellent kit for measuring

the output of phono cartridges and the gain of amplifier stages. Use it also to check power supply ripple, as a sensitive null detector, and for compiling frequency response data. Features one knob operation, 200 microampere Simpson meter and precision resistors.

Heathkit AUDIO WATTMETER KIT

Read audio power output directly without using external load resistors with the new Heathkit Audio Wattmeter. Built-in non-inductive load resistors provide impedances of 4, 8, 16, and 600 ohms. Flat response from 10 CPS to 250 KC. Full scale power ranges are 0-5 MW, 0-50 MW, 0-500 MW, 0-5 W and 0-50 W. Model AW-1 will operate continuously at 25 watts and has a duty cycle of 3 minutes at 50 watts. Total db range in five positions is -50 db to +48 db, using the standard 1 milliwatt 600 ohms.

MODEL AW-1

\$29.50

Shpg. Wt. 6 lbs.



Heathkit 30,000 VOLTS DC PROBE KIT

Measure up to 30,000 volts DC with the Heathkit VTVM and the 336 high voltage Probe. Precision resistor provides multiplication factor of 100. Can be used with any 11 megohm input VTVM. Housed in a Polystyrene two color sleek plastic probe body for safety of operation.

No. 336

\$4.50

Shpg. Wt. 1 lb.

Heathkit PEAK-TO-PEAK PROBE KIT



No. 338-C

\$5.50

Shpg. Wt. 2 lbs.

Peak-to-peak values not exceeding 80 volts at a DC level of not more than 600 volts, can now be read directly by using 338-C Probe with previous model Heathkit VTVM's or any VTVM with 11 megohm input resistance. Probe construction features a modern printed circuit board for easy assembly. Frequency range 5 KC to 5 MC.

Heathkit RF PROBE KIT

The Heathkit RF Probe will permit the measurement of RF voltages up to 250 MC with an accuracy of $\pm 10\%$. The limits are 30 volts AC and a DC level of 500 volts. Designed for any 11 megohm input VTVM. Modern styling, Polystyrene aluminum housing, Polystyrene insulation, and printed circuit board for easy assembly.



No. 309-C

\$3.50 Shpg. Wt. 1 lb.

HEATH company
BENTON HARBOR 15,
MICHIGAN

Heathkit 6-12 VOLT BATTERY ELIMINATOR KIT

Here is the new 12 volt Heathkit Battery Eliminator so necessary for modern up-to-date operation of your Service Shop. Furnishes either 6 or 12 volt output which can be selected at the flick of a panel switch. Use the BE-4 to service all of the new 12 volt car radios in addition to the conventional 6 volt models.

RANGES:

This new Battery Eliminator provides two continuously variable output voltage ranges. 0-6 volts D.C. at 10 amperes continuously or 15 amperes maximum intermittent and 0-12 volts D.C. at 5 amperes continuously or 7.5 amperes maximum intermittent. The output voltage is clean and well filtered, as the circuit uses two 10,000 mfd condensers.

The continuously variable voltage output feature is of definite aid in determining the starting point of vibrators, the voltage operating range of oscillator circuits, etc.

OTHER USES:

The controllable low voltage DC supply has many other applications besides primary use in car radio service work. Can be nicely used as a battery charger, or low voltage DC supply for electric trains. Has applications in high gain audio work requiring clean DC filament supply. Can be used for low power electro-plating or as a power supply for battery powered intercommunication systems.

Automatic overload relay—self resetting—fuse protected.

New 18 plate split type, heavy duty rectifier unit.



Continuously variable output voltage, either 6 or 12 volt operation.

Constant ammeter and voltmeter monitoring.

MODEL BE-4

\$31.50

Shpg. Wt. 17 lbs.

Heathkit VIBRATOR TESTER KIT

MODEL VT-1

\$14.50

Shpg. Wt. 6 lbs.



This time-saving device will quickly pay for itself in your auto radio service shop. 6 volt vibrators can be checked instantly on the Good-Bad type meter scale. Operation requires only a variable DC voltage from 4 to 6 volts at 4 amperes. Model BE-4 Battery Eliminator is recommended for this application.

Five test sockets provide for the testing of hundreds of interrupter and self-rectifier types. Proper starting voltage is determined easily and accurately. Over-all quality is then unmistakably indicated on the panel mounted meter.

Heathkit IMPEDANCE BRIDGE KIT

MODEL IB-2

\$59.50 Shpg. Wt. 12 lbs.



The new Heathkit Impedance Bridge features built-in adjustable phase shift oscillator and amplifier. This instrument actually represents four instruments in one compact unit. The Wheatstone bridge for resistance measurements, the Capacity Comparison bridge for capacity measurements, Maxwell bridge for low Q, and Hay bridge for high Q measurements.

DESIGN:

Panel provisions for external generator use. A new two section CRL dial, provides ten separate "units." Ten separate units switch settings and fractions of units are read on a continuously variable calibrated control. A special minimum capacity shielded and balanced impedance matching transformer between the generator and bridge circuit is automatically switched to provide correct load operation of the generator circuit. The instrument uses 1/2% precision resistors and condensers in all measurements circuits.

Heathkit VARIABLE VOLTAGE ISOLATION TRANSFORMER KIT

Variable output voltage between 90 and 130 volts AC. Rated at 100 volt—amperes continuously and 200 volt—amperes intermittently. The principle function of the Heathkit Isolation Transformer is to isolate the circuit being tested from line interference being caused by motors, appliances, etc. It works backward too by isolating such devices from the line. Many other uses, especially with AC-DC type circuits. Do not confuse the Heathkit Isolation Transformer with the hazardous auto transformer type line voltage boosters.

MODEL IT-1

\$16.50

Shpg. Wt. 10 lbs.



HEATH company
BENTON HARBOR 15,
MICHIGAN

What I wanted was an antenna that was light, simple, unobtrusive, and sufficient for the job at hand. The new antenna is doing all I expected and more. While I'm not willing to say positively it has as much gain on channel 6 as my trusty old yagi—that's a good bit to ask of any broadband antenna—it comes so close the difference is negligible. On the other channels it seems to perform every bit as well as my old-fashioned two-bay conical in spite of the fact it does not weigh one-fifth as much.

"The front-to-back ratio—an increasingly important factor as more and more stations come on the air—is greatly superior to what I had before, even with the yagi. I believe the reason for this is that I always had a certain amount of signal transfer from the conical lead-in, both directly and by leakage through the change-over switch, that impaired the apparent yagi front-to-back ratio. On several occasions I have been able to tune in three different stations on the same channel, without interference, simply by rotating the new antenna. What's more, on a hot night a few weeks back I was able to pick up a station on every v.h.f. channel—something I never could accomplish with the imposing antenna array I had before."

"Then you're about convinced the antenna design boys have really learned something in the past three years," Barney suggested.

"Yep," Mac admitted with a grin, "I believe they have."

"Now that's settled," Matilda observed tartly as she gathered up the empty bottles, "what say we close up shop for the day?"

"The most intelligent suggestion I've heard yet this year!" Barney applauded as he shucked off his shop coat and reached for his hat. —30—

ADAPTER PROTECTOR

By H. LEEPER

TO AVOID possible damage to the pins of small miniature adapters, used to check voltages at tube sockets without pulling the chassis, try using 35 mm film containers, available at photo shops.

Such film containers are about 2 inches in height, 1 1/4 inches in diameter and have screw-on caps. —30—

Film containers will protect adapters.



NEW *Heathkit* TV ALIGNMENT GENERATOR KIT

Here is the most radically improved Sweep Generator in the history of the TV service industry. The basic design follows latest high frequency techniques which result in a combination of performance features not found in any other sweep generator.

SWEEP:

Sweep action is obtained electronically through the use of a newly developed controllable inductor, thereby eliminating all moving parts with their resultant hum, vibration, fatigue, etc. Frequency coverage entirely on fundamentals, is continuous from 4 MC to 220 MC at an output level well over a measurable .1 volt.

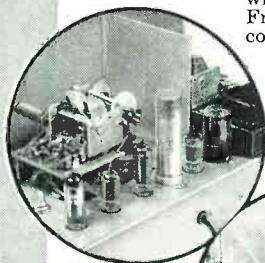

Triple marker system. 4.5 MC crystal controlled marker—continuously variable marker—provisions for external marker.

Automatic amplitude control circuit—constant output voltage regulated power supply.



Controllable inductor sweep oscillator with output entirely on fundamentals.

Electronically operated, smooth continuously variable sweep hum or noise.

Triple marker system 4.5 MC crystal controlled—3 sets of cables included.



Frequency coverage: 4 MC—220 MC continuous including FM spectrum. RF output well over .1 volt.

MODEL TS-3

\$44.50

Shpg. Wt. 18 lbs.

MARKER:

The same instrument incorporates a triple marker system with a crystal controlled reference. A variable marker provides accurate coverage from 19 to 60 MC on fundamentals, and 57 to 180 MC on calibrated harmonics. A separate fixed crystal controlled 4.5 MC marker can be used for checking IF, band-pass, calibration, reference, etc. Provisions are also made for external marker use. A 4.5 MC crystal is supplied with the kit.

POWER SUPPLY:

The transformer operated Power Supply features voltage regulation for stable oscillator operation. Three sets of shielded cables are furnished with the kit. Sweep range is completely and smoothly controllable from zero up to a maximum of 50 MC, depending upon base frequency.

Here is a TV Sweep Generator that truly no serviceman can afford to be without for rapid, accurate, TV alignment work.

NEW *Heathkit* SIGNAL GENERATOR KIT



MODEL SG-8

\$19.50 Shpg. Wt. 8 lbs.

The new Heathkit service type Signal Generator, Model SG-8 incorporates many design features not usually found in this instrument price range. Frequency coverage is from 160 KC to 110 MC in five ranges, all on fundamentals, with useful calibrated harmonics up to 220 MC. The RF output level is well in excess of 100,000 microvolts throughout the frequency range. The oscillator circuit consists of a twin triode tube, one-half used as a Colpitts oscillator, and the other half as a cathode follower output which acts as a buffer between the oscillator and external load, thereby eliminating oscillator frequency shift usually caused by external loading.

All coils are factory wound and adjusted, thereby completely eliminating the need for individual calibration and the use of additional calibrating equipment. The stable, low impedance output, features step and variable attenuation for complete control of RF level. A separate 6C4 triode acts as a 400 cycle sine wave oscillator, and a panel mounted switching system permits choice of either external or internal modulation.

NEW *Heathkit* BAR GENERATOR KIT



MODEL BG-1

\$14.50 Shpg. Wt. 4 lbs.

The Heathkit BG-1 produces a series of horizontal or vertical bars on a TV screen. Since these bars are equally spaced, they will quickly indicate picture linearity of the receiver under test without waiting for transmitted test patterns. Panel switch provides "standby"—horizontal and vertical position. The oscillator unit uses a 12AT7 twin triode for the RF oscillator and video carrier frequencies. A neon relaxation oscillator provides low frequency for vertical linearity tests. The instrument will also provide an indication of horizontal and vertical sync circuit stability as well as overall picture size. Operation is simple and merely requires connection to the TV receiver antenna terminal. Transformer operated for safety.

Heathkit LABORATORY GENERATOR KIT



MODEL LG-1

\$39.50

Shpg. Wt. 16 lbs.

The new Heathkit Laboratory type Signal Generator definitely establishes a new performance standard for a kit instrument. An outstanding feature involves the use of a panel mounted 200 microampere meter calibrated both in microvolts and percent modulation, thereby providing a definite reference level for using the Signal Generator in design work, gain measurements, selectivity, frequency response checks.

DESIGN:

Additional design features are copper plated shield enclosure for oscillator and buffer stages resulting in effective double shielding. Fibre panel control shaft extensions in RF carrying circuits, thorough AC line filtering, careful shielding of the attenuator network, voltage regulated B plus supply, selenium rectifier, etc.

RANGES:

Frequency coverage from 150 KC to 30 MC all on fundamentals in five separate ranges. Output voltage .1 volt with provisions for metered external or internal modulation. Output impedance termination 50 ohms. Transformer operated power supply.

Investigate the many dollar stretching features offered by the LG-1 before investing in any generator for Laboratory or Service work.

HEATH company
BENTON HARBOR 15,
MICHIGAN

Heathkit VISUAL-AURAL SIGNAL-TRACER KIT

The new Heathkit Visual-Aural Signal Tracer features a special high gain RF input channel used in conjunction with a newly designed wide frequency range demodulator probe. High RF sensitivity permits signal tracing from the receiver antenna input. Separate low gain channel and probe available for audio circuit exploration. Both input channels are constantly monitored by an electron ray beam indicator so that visual as well as aural indications may be obtained.

NOISE LOCATOR:

A decidedly unusual feature is a noise locator circuit used in conjunction with the audio probe. With this system, a DC potential is applied to a suspected circuit component and the action of the voltage in the component can be seen as well as heard. Invaluable for ferreting out noisy or intermittent condensers, noisy resistors, controls, IF and power transformers, etc.

WATTMETER:

Built-in calibrated wattmeter circuit will prove useful for quick preliminary check of total wattage consumption of equipment under test. Separate panel terminals provide external use of the speaker or output transformer for substitution purposes. Saves valuable service time by eliminating the necessity for speaker removal on every service job. The same panel terminals also provide easy access to a well filtered B plus supply for external use. Don't overlook the many interesting service possibilities provided through the use of this instrument, and let the Signal Tracer work for you by saving time and money.

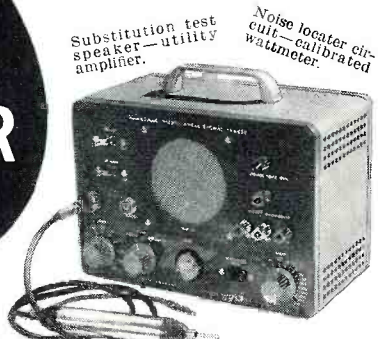

Substitution test speaker—utility amplifier.
Noise locator circuit—calibrated wattmeter.

RF and audio probes supplied along with necessary test leads.

Visual and aural signal tracing.

MODEL T-3
\$23.50
Shpg. Wt. 9 lbs.

Heathkit CONDENSER CHECKER KIT

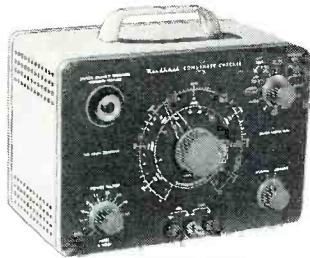

MODEL C-3
\$19.50 Shpg. Wt. 7 lbs.

Here is a handy test instrument for any Service Shop. Unknown values of capacity and resistance are quickly determined on the direct reading condenser checker dial. Capacity is measured in four ranges from .001 mfd to 1000 mfd. Resistance in the range from 100 ohms to 5 megohms.

DC polarizing voltages of 25, 150, 250, 350, and 450 volts are available for leakage tests on all types of condensers. For electrolytics, a power factor control is provided to balance out inherent leakage and to indicate directly the power factor of a condenser under test. Proper balancing of the AC bridge is reflected in the degree of closure of an electron beam indicator tube.

Model C-3 uses a transformer operated power supply, spring return leakage test switch, and a convenient combination of panel scales for all readings. Test leads are furnished in addition to precision components for calibrating purposes. Quick and easy to operate, the Heathkit Condenser Checker will save valuable time and increase your Shop efficiency.

Heathkit "Q" METER KIT



MODEL QM-1
\$44.50
Shpg. Wt. 14 lbs.

The Heathkit QM-1 represents the first practical popular priced Q meter available within the price range of schools, laboratories, TV service men, and experimenters. This instrument will enable the operator to simulate conditions encountered in practical circuits and to measure the performance of coils or condensers at the operating frequencies actually encountered. All indications of value are read directly on the 4 1/2" 50 microampere Simpson calibrated meter scale. Measures Q of condensers, RF resistance, and the distributed capacity of coils. Oscillator section supplies RF frequencies 150 KC to 18 MC in four ranges. Calibrate capacity with range of 40 MMF to 450 MMF with vernier of ±3 MMF. Investigate the many services this instrument can perform for you.

Heathkit AUDIO OSCILLATOR KIT

MODEL AO-1
\$24.50
Shpg. Wt. 10 lbs.



The Heathkit Audio Oscillator will produce both sine and square waves within the frequency range from 20 CPS to 20 KC in three ranges. Thermistor controlled linearity results in a variation of no more than ±1 db in a 10 volt (no load) variable output level. There will be less than .6% distortion from 100 CPS throughout the audible range. Low impedance 600 ohm output. Precision 1% resistors, used in the range multiplier circuits to provide accurate calibration.

HEATH company
BENTON HARBOR 15,
MICHIGAN

TV STUDIO LIGHTING CONTROL

Electronic controls make for imaginative lighting.

HOW often in viewing a TV show do you notice the lighting? Perhaps once or twice when you saw a particularly excellent dramatic show, you may have thought that the use of lights was an effective part of the production. On the whole, good lighting is that which enhances a show without detracting from it.

To give this kind of lighting, most TV studios today use some type of electronic control. Studios have come a long way from the hand-placed spotlight and floodlight era. Although modern TV cameras with their sensitive image orthicon tubes do not require as much over-all illumination as their predecessors, still the number of lights used to set a mood in any one scene is quite large. Electronic control allows the operator to adjust each light in an over-all lighting pattern precisely and rapidly. It also allows the operator to preset a complete lighting setup for two or more scenes, and then jump from scene to scene following the dramatic action with the correct lighting for each.

The lighting-control equipment shown on this month's cover was designed by *Kliegl Brothers* for the Miami, Florida television station, WTVJ. The console at which the operator is seated controls the adjustment of all lights in a particular scene. The operator can dim or bring up individual lights or banks of lights. He can effect slow or rapid scene fade-outs. He can also switch from one scene to another.

The control board behind him contains individual step controls for each lighting outlet in the studio. The operator can connect, by means of this board, any light outlet to any of the dimmer switches on the control console. Of course, there are also non-dimming switches on this console for rapid light changes. In addition to this electronic means of control, the position of each light may be varied as to height or distance from the scene, so as to obtain various moods and shadow effects. This feature is not electronically controlled.

Some indication of the power consumed in lighting a typical dramatic scene in a TV show may be gained from the fact that the console control board has a total capacity of 120 kilowatts, servicing 171 light outlets. It is equipment such as this which gives present-day television production its highly professional appearance.

Heathkit TUBE CHECKER KIT

The Heathkit TC-2 Tube Checker was primarily designed for the convenience of radio and TV servicemen and will check the operating quality of tubes commonly encountered in this type of work. Test set-up procedure is simplified, rapid, and flexible. Panel sockets accommodate 4, 5, 6, and 7 pin tubes, octal and loctal, 7 and 9 pin miniatures, 5 pin Hytron, and a blank socket for new tubes. Built-in neon short indicator, individual 3-position lever switch for each tube element, spring return test switch, 14 filament voltage ranges, and line-set control to compensate for supply voltage variations, all represent features of the TC-2.

Illuminated reading and quick identification of chart

Simplified construction—new harness type wiring—closer tolerance resistors.

Smart, professional appearance—a valuable in counter or portable models.

Three color Good-BAD plastic cased meter.

Improved smooth running roll chart mechanical action.

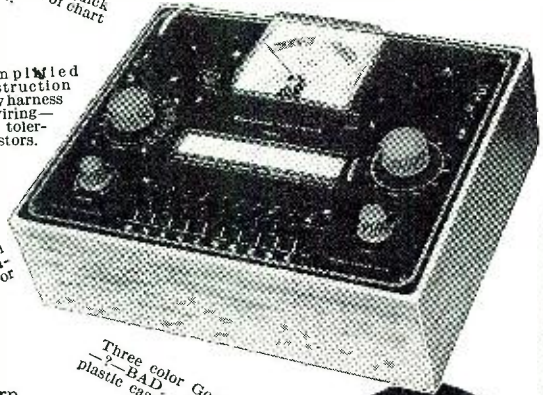

MODEL TC-2

\$29.50

Shpg. Wt. 12 lbs.

Results of tube tests are read directly from the large 4 1/2" Simpson 3-color meter. Checks emission, shorted elements, open elements, and continuity. Wiring procedure has been simplified through the use of multi-wired color coded cable providing a harness type installation between tube sockets and lever switches. This procedure insures standard assembly and imparts a "factory built" appearance to the instrument. New Construction Manual furnishes detailed information regarding tube set-up procedure for testing of new or unlisted tube types. No delay necessary for release of factory data.

Heathkit PORTABLE TUBE CHECKER KIT

The portable model is supplied with a strikingly attractive two-tone cabinet finished in rich maroon proxylin impregnated fabric covering with a contrasting gray on the inside of the detachable cover.

MODEL TC-2P

\$34.50

Shpg. Wt. 15 lbs.



Heathkit REGULATED POWER SUPPLY KIT

MODEL PS-2

\$33.50

Shpg. Wt. 15 lbs.

Here is a source of regulated D.C. voltage for circuit development work. Power supply voltage and current drain to the circuit under test are constantly monitored by the 4 1/2" panel mounted meter. Separate 6.3 volt at 4 ampere A.C. filament source available. The regulated and variable output voltage will be constant over wide load variations, and hum ripple will not exceed .012% at 250 volts under a 50 MA load. Completely isolated circuit, standby switch, and other desirable features, make the Model PS-2 extremely useful in a wide variety of applications.

Heathkit AUDIO GENERATOR KIT

Here is an Audio Generator with features generally found only in the most expensive instruments. Sine wave coverage from 20 cycles to 1 Megacycle—response flat ± 1 db from 20 cycles to 400 Kc—continuously variable and step attenuated output. Because the output voltage is relatively constant over wide frequency ranges, the AG-8 is ideal for running frequency response curves in audio circuits. Once set by means of the attenuator, this voltage may be relied upon for accuracy within ± 1 db. Instrument features low impedance 600 ohm output circuit and distortion less than .4 of 1% from 100 CPS through audible range.

MODEL AG-8

\$29.50

Shpg. Wt. 11 lbs.



Heathkit TV PICTURE TUBE TEST ADAPTER

The Heathkit TV Picture Tube Test Adapter used with the Heathkit Tube Checker Kit, will quickly check picture tubes for emission, shorts, etc. and determine tube quality. Consists of standard 12-pin TV tube socket, four feet of cable, octal socket connector, and data sheet.



No. 355

\$4.50 Shpg. Wt. 1 lb.

Heathkit DECADE RESISTANCE KIT

MODEL DR-1

\$19.50

Shpg. Wt. 4 lbs.

Twenty 1% resistors are decaded in 1 ohm steps to provide any value between 1 ohm and 99,999 ohms. Sturdy ceramic switches with silver plated contacts insure reliable service. Use the Decade Resistance in bridge circuits, meter multipliers, calibrations, or any application requiring a wide range of precision resistance values.



Heathkit DECADE CONDENSER KIT

MODEL DC-1

\$16.50

Shpg. Wt. 3 lbs.

The Heathkit Decade Condenser provides a ready source of capacity values from 100 mmf to .111 mfd inclusive in capacity steps of 100 mmf. Silver plated contacts on husky ceramic switches, assure positive contact for each switch position. Precision silver mica condensers $\pm 1\%$ accuracy for close tolerance accurate work.



HEATH company
BENTON HARBOR 15,
MICHIGAN

NEW *Heathkit* HIGH FIDELITY PREAMPLIFIER KIT

Here is the exciting new Heathkit Preamplifier with all of the features you Audiophiles have asked for and at a down-to-earth price level. Beautiful satin gold baked enamel finish, striking control knobs and arrangement, attractive custom appearance and entirely functional design.

DESIGN:

Uses three twin triode tubes in a shock mounted chassis, 2-12AX7 and 1-12AU7. Features tube shielding, plastic sealed color coded capacitors, smooth acting controls, good filtering, excellent decoupling, low hum and noise level, and all aluminum cabinet. Special balancing control for absolute minimum hum level. Cathode follower, low impedance output circuit for complete installation flexibility.

SPECIFICATIONS:

Provides five switch selected inputs, 3 high level, and two low level, each with individual level controls—4 position LP, RIAA, AES, and early 78 equalization switch—4 position roll-off switch, 8, 12, 16 with one flat position. Separate tone controls, bass 18 db boost and 12 db cut at 50 CPS, treble 15 db boost, and 20 db cut at 15,000 CPS. Power re-

Equalization for LP, RIAA, AES, and early 78.

Separate bass and treble tone controls—special hum control.

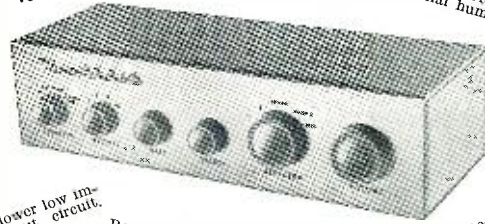

Cathode follower low impedance output circuit.

Beautiful, modern appearance, blends with any interior or color scheme.

Five switch selected inputs with individual level controls.

quirements from Heathkit Williamson Type Amplifier power supply 6.3 volts AC at 1 ampere, and 300 volts DC at 10 MA. Over-all dimensions 12 $\frac{1}{2}$ " wide x 5 $\frac{1}{2}$ " deep x 3 $\frac{1}{2}$ " high.

APPLICATION:

The new Heathkit WA-P2 Preamplifier has been designed to operate with any of the Heathkit Williamson Type Amplifiers and is directly interchangeable with the previous Model WA-P1 Preamplifier unit. Order your kit today and enjoy completely smooth control over the operation of your Hi-Fi system. Obtain the exact tonal balance of bass and treble with the precise degree of equalization you want. Note that the design of the WA-P2 accommodates the newly established RIAA curve.

MODEL WA-P2

\$19.75

Shpg. Wt. 7 lbs.

HAM EQUIPMENT

Single knob band switching—prewound coils.

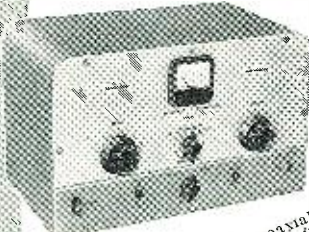

Crystal or VFO excitation—metered operation.

52 Ohm coaxial output—built-in power supply.

MODEL AT-1

\$29.50

Shpg. Wt. 16 lbs.

filter, good shielding and a 52 ohm coaxial output. The 425 volt, 100 milliamper power supply and 5U4 rectifier are more than adequate for the 6AG7 oscillator multiplier and 6L6 amplifier doubler.

Heathkit AMATEUR TRANSMITTER KIT

The Heathkit AT-1 Transmitter has established a high reputation and has been enthusiastically accepted by hundreds of experienced operators as well as beginners. Power input up to 35 watts for the novice and suitable as a standby exciter for your higher powered rig later on.

Model AT-1 can be crystal or VFO excited and operates on 80, 40, 20, 15, 11 and 10 meters. The prewound coils with the oscillator and amplifier are switched simultaneously by the rugged band switch. Meter switch allows a reading of the final grid and plate current on the panel mounted meter. Modulator input and VFO power sockets are provided as well as a key jack for CW operation. Other features include a crystal socket, standby switch, key click filter, AC line

Brand
NEW

Smooth acting illuminated and precalibrated dial.

HEATHKIT VFO KIT

The new Heathkit VFO is the perfect companion to the Heathkit Model AT-1 Transmitter and it has sufficient output to drive any multi-stage transmitter of modern design. Good mechanical and electrical design insures operating stability. Coils are wound on stable, heavy duty, ceramic forms using Litz or double cellulose wire coated with Polystyrene cement and baked for humidity protection. Variable capacitor of differential type construction, especially designed for maximum bandspread. Kit is furnished with a carefully precalibrated scale which provides well over two feet of scale length. Smooth acting vernier reduction drive and illuminated dial provides easy tuning and zero beating.

Power requirements 6.3 volts AC at .45 amperes, and 250 volts DC at 15 mls. Just plug it into the power receptacle provided on the rear of the AT-1 Transmitter. Seven band coverage 160 through 10 meters with 10 volt average RF output. Uses 6AU6 electron coupled Clapp oscillator and OA2 voltage regulator.

Copper plated chassis—aluminum cabinet—easy to build.

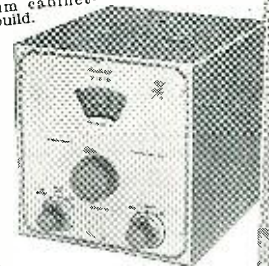

Seven band coverage 160 through 10 meters at 10 volt RF output.

6AU6 electron coupled Clapp oscillator and OA2 voltage regulator.

MODEL VF-1

\$19.50

Shpg. Wt. 7 lbs.

Heathkit GRID DIP METER KIT

The invaluable instrument for Hams, servicemen and experimenters. Useful in TV service work, for alignment of traps, filters, IF stages, peaking compensation networks, etc. Locates spurious oscillation, provides a relative indication of power in transmitter stages. Use it for neutralization, locating parasites, correcting TVI, measuring CL and Q of components, and determining RF circuit resonant frequencies. The variable meter sensitivity control, headphone jack, 500 microampere Simpson meter, continuous frequency coverage from 2 MC to 250 MC. Prewound coil kit and rack included.

LOW FREQUENCY COILS:

Low frequency range extended to 355 KC by the use of two additional coils. Complete with dial correlation curves. Set 341-A for GD-1B and set 341 for GD-1A. Shpg. wt. 1 lb. Price \$3.00



MODEL GD-1B

\$19.50

Shpg. Wt. 4 lbs.

Heathkit ANTENNA IMPEDANCE METER KIT

MODEL AM-1

\$14.50

Shpg. Wt. 2 lbs.

Determine antenna resonance and resistance, transmission line surge impedance, and receiver input impedance. Works with one-half and one-quarter wave lines, half wave and folded dipoles, harmonic mobile and beam antennas. Resistance type SWR bridge—100 microampere meter—frequency range 0-150 MC—impedance range 0-600 ohms.



MODEL AC-1

\$14.50

Shpg. Wt. 4 lbs.

Heathkit ANTENNA COUPLER KIT

For the Heathkit AT-1 Transmitter or any comparable Amateur Transmitter. Will handle power up to 75 watts at its 52 ohm coaxial input. Matches a wide range of antenna impedances with its L type tuning network and neon indicator. A tapped inductance provides coarse adjustment and a transmitting type variable condenser sets it "right on the nose." Will operate on the 10 through 80 meter bands.

HEATH company
BENTON HARBOR 15,
MICHIGAN

New LOW PRICED HEATHKIT SINGLE UNIT Williamson Type High Fidelity AMPLIFIER KIT

Rugged, heavy duty,
single chassis con-
struction.

Output impedances
4, 8, and 16 ohms.

Standard
brand com-
ponents used,
no sacrifice of
quality.



Lowest price high quality
Williamson Type Ampli-
fier ever offered.

Send for
free booklet
High
Fidelity
Especially
For You.

Here is the newest Heathkit Hi-Fi Amplifier at the lowest price ever quoted for a complete Williamson Type Amplifier circuit. The W-4 Model has been designed for single chassis construction, and only for the new Chicago Transformer Company Model BO-13 "super range" high fidelity output transformer. This transformer, a new development in the Hi-Fi field, is being offered at substantial saving over transformers of comparable quality. It is outstanding in performance and on the basis of our tests, we find it equal in every respect to transformers used in the W-2 and W-3 Heathkit series.

LOW PRICES:

Through utilization of a single chassis with resultant economy obtained through elimination of duplicate sheet metal fabrication, connecting cables, plugs, sockets, and a new Chicago "super range" output transformer, a 20% price reduction has been made possible without sacrificing kit quality.

COMPONENTS:

The new Heathkit W-4 uses the same heavy duty power transformer and choke. It has all of the features of previous models including individual jacks and a wire wound control to balance the output tubes—plastic high quality capacitors and the exact circuitry previously utilized in Williamson Type Amplifiers. Intermodulation distortion and harmonic distortion are both at the same low level as in the W-2 and W-3 models.

CONSTRUCTION:

Here is the opportunity for even the economy minded Hi-Fi enthusiast to enjoy all of the advantages offered through Hi-Fi reproduction of fine recorded music. Simplified step-by-step Construction Manual completely eliminates necessity of electronic knowledge or special equipment. Assemble this Amplifier in a few pleasant hours.

COMBINATIONS AVAILABLE

W-4M with Chicago "super-range" trans-
former only. Single chassis main amplifier
and power supply. Shipping **\$39.75**
weight 28 lbs. Express only

COMBINATION W-4 with Chicago
"super-range" transformer only includes
single chassis main amplifier and power supply
with WA-P2 preamplifier **\$59.50**
kit. Shpg. wt. 35 lbs. Express only

NEW Heathkit 20 WATT High Fidelity AMPLIFIER KIT

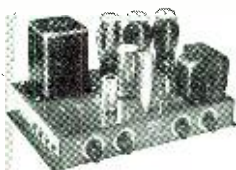

MODEL A-9B

\$35⁵⁰

Shpg. Wt. 24 lbs.

In keeping with the progressive policy of the Heath Company, further improvement has been made in the already famous Heathkit High Fidelity 20 Watt Amplifier. Additional reserve power has been obtained by using a heavier power transformer. A new output transformer designed and manufactured especially for the Heath Company, now provides output impedances of 4, 8, 16 and 500 ohms. The harmonic distortion level will not exceed 1% at the rated output.

FEATURES:

Outstanding features of the Heathkit 20 watt Amplifier include frequency response of ± 1 db from 20 CPS to 20 KC. Separate (boost and cut) bass and treble tone controls. Four switch selected input jacks and a special hum balancing control. Flexibility is emphasized in the input circuits and proper equalization for all input devices is incorporated.

TUBE LINEUP:

12AX7 magnetic preamplifier and first audio amplifier. 12AU7 two stage amplifier with tone controls. 12AU7 voltage amplifier and phase splitter. Two 6L6 push-pull beam power output and 5U4G rectifier. The Heathkit Model A-9B is excellent for custom installation and is designed for outstanding service at a very reasonable cost.

Heathkit SIX WATT AMPLIFIER KIT

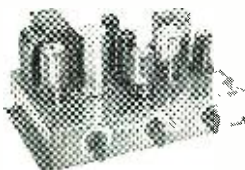

MODEL A-7B

\$15⁵⁰

Shpg. Wt. 10 lbs.

An outstanding value, this economically priced 5 watt Amplifier is capable of performance expected only in much more expensive units. Only 2 or 3 watts output will ever be used in normal home applications and Model A-7B will be more than adequate for this purpose.

SPECIFICATIONS:

Two switch selected inputs are available for crystal and ceramic phono pickups, tuner, TV audio, tape recorder, and carbon type microphone. Model A-7B features separate bass and treble tone controls, push-pull balanced output stages, output impedances of 4, 8, and 15 ohms, and extremely wide frequency range $\pm 1\frac{1}{2}$ db from 20 CPS to 20 KC. Not just a souped up AC-DC job. Full wave rectification, transformer operated power supply and good filtering, result in exceptionally low hum level.

MODEL A-7C

Provides a preamplifier stage and proper compensation for the variable reluctance cartridge and low level microphone. \$17.50

COMBINATIONS AVAILABLE:

W-3 Amplifier Kit (Includes Main Amplifier with Acrosound Output Transformer, Power Supply and WA-P2 Preamplifier.) Shipping weight 37 lbs. Shipped express only... **\$69.50**

W-3M Amplifier Kit (Includes Main Amplifier with Acrosound Output Transformer and Power Supply.) Shipping weight 29 lbs. Express only **\$49.75**

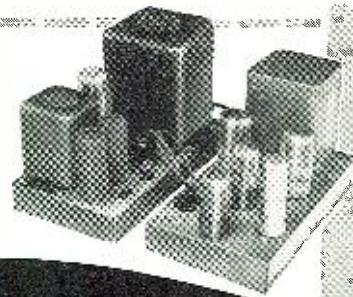

Heathkit WILLIAMSON TYPE AMPLIFIER KIT

Here is the famous kit form Williamson Type high fidelity Amplifier that has deservedly earned highest praise from every strata of Hi-Fi music lovers. Virtually distortionless, clean musical reproduction, full range frequency response, and more than adequate power reserve.

OUTPUT TRANSFORMERS:

This outstanding Williamson Type Hi-Fidelity Amplifier is supplied with the famous Acrosound TO-300 output transformer. This quality transformer features the popular "ultra-linear" output circuit for clean maximum power level. Separate chassis for amplifier and power supply.

SPECIFICATIONS:

Frequency response within 1 db from 10 cycles to 100,000 cycles. Harmonic distortion at 5 watt output less than .5% between 20 cycles and 20,000 cycles. 1M distortion at 5 watts equivalent output .5% using 60 and 3,000 cycles. Output impedances of 4, 8, or 16 ohms. Overall dimensions for each unit 7" high x 5 $\frac{1}{2}$ " wide x 11 $\frac{1}{2}$ " long.

CONSTRUCTION MANUAL:

This fine kit is supplied with a completely detailed step-by-step Construction Manual and the only effort required is the assembly and wiring of the pre-engineered kit. Even the complete novice can successfully construct this Amplifier and have fun building it.

HEATH company
BENTON HARBOR 15,
MICHIGAN

A CONELRAD MONITOR

By L. DAVID OLIPHANT
Transmitter Engineer, Station KTUL

Construction details on a broadcast station monitor for "Conelrad" signals that is easy to build and foolproof.

SINCE probably many RADIO & TELEVISION NEWS readers work at broadcast stations and since broadcasters must now monitor certain key stations for possible air raid alerts, the equipment to be described will undoubtedly be of interest.

Since key stations will interrupt their carriers before giving air raid alert warnings, the simplest and most straightforward method of monitoring such key stations would be to have a relay operate or close upon such carrier interruptions and remain closed after the return of the station's carrier until opened by the operator. The relay would keep open a portion of the audio circuit of a receiver and, upon closing, cause the circuit to operate normally. Thus, with the return of the key station's carrier, the operator may then hear the program. He then may be alerted if the warning of an impending air raid is broadcast and can take the proper precautionary measures.

The availability of a sensitive meter-relay, the Weston "Sensitrol" Model 705, which operates on a current of only 5 microamperes, makes possible the simple tubeless tuner shown in Fig. 1. This circuit worked well with our key station monitor because the carrier of the key station is of sufficient strength at our transmitter to give more than ample rectified current to operate the relay after passing through the filters and wave traps that attenuate the desired carrier due to the broad nature of the tuned filter circuit.

While the diagram appears simple, perhaps its evolution would be of interest to some of the readers. The main problem was not so much to build a tuned circuit to receive the key station whose carrier is 1170 kc. as to devise a method for filtering out our own carrier of 1430 kc. Since the receiver was to be operated under our transmitter, our signal was so strong that any simple tuned circuit or gang-tuned circuits tuned to 1170 kc. would still admit enough of our carrier to override

the program of our key station and render it unintelligible.

The output voltage across the second tuned circuit of the tuner, Fig. 1, when tuned to the key station is .75 volt while the voltage across the same circuit when the tuner was tuned to our carrier (same antenna) is 45 volts.

The circuit which finally evolved was the result of years of work, hours of thumbing textbooks, and sheer luck.

From the diagram of Fig. 1, it might be assumed that the tank circuit, L_1-C_1 , is tuned to 1430 kc., our carrier, to block it out. Experiments will prove, however, that with ordinary coils such a tank circuit would block too much of the desired 1170 kc. carrier when tuned to 1430 kc. Unless the coil is truly remarkable, the impedance curve of anti-resonant circuit L_1-C_1 , when tuned to 1430 kc., is rather broad at best and has enough impedance at 1170 kc. so that too little carrier will get through to be worthwhile. This circuit will receive the key station under our towers but quite a bit of our program is still present in the signal.

Fig. 2A is a simplified version of Fig. 1. C_1-L_3 is a series-tuned circuit tuned to 1170 kc. and L_2-C_2 is a series circuit tuned to 1430 kc. (our carrier) to shunt it out. Studies of anti-resonant circuitry reveals that at frequencies above the frequency to which the circuit is tuned, the circuit is capacitive.

Now examine Fig. 2B. Coil L_1 is placed across C_1 and this anti-resonant circuit tuned to some frequency below 1170 kc. so that the capacitance it shows at 1170 kc. will resonate with L_3 , admitting that frequency through the equivalent series-tuned circuit. In Figs. 2A and 2B, coils L_3 and L_1 are inductively coupled. C_1 in Figs. 2B and 1, as well as in Fig. 2A, is tuned for maximum output current for 1170 kc.—the carrier of our key station—not to anti-resonate with L_1 at 1430 kc.—our carrier—because if L_1-C_1 anti-resonates at 1430 kc. barely enough of our key station's carrier gets through to register.

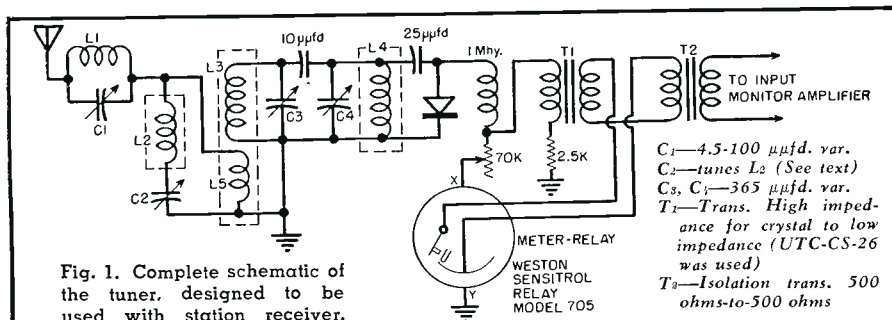
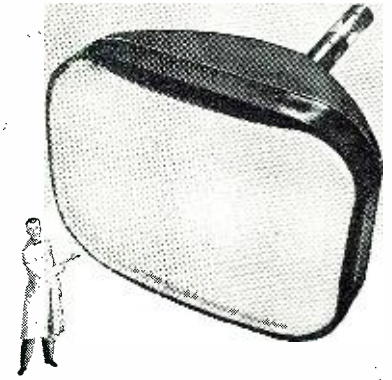

Fig. 1. Complete schematic of the tuner, designed to be used with station receiver.

Quality Features OF TUNG-SOL PICTURE TUBES



Gun made of best grade non-magnetic steel.

Glass bead type assembly is stronger both mechanically and electrically—gives greater protection against electrical leakage.

Rolled edges in gun minimize corona.

Custom built stem with greater spacing between leads assures minimum leakage.

Low resistance of outside conductive coating minimizes radiation of horizontal oscillator sweep frequency.

Double cathode tab provides double protection against cathode circuit failure.

Selected screen composition resists burning (X pattern).

Rigid control of internal conductive coating provides utmost service reliability.

Designed for use with single or double field ion trap designs.

One-piece construction of parts assures better alignment.

Maximum dispersion of screen coating assures uniform screen distribution.

Tung-Sol makes All-Glass Sealed Beam Lamps, Miniature Lamps, Signal Flashers, Picture Tubes, Radio, TV and Special Purpose Electron Tubes and Semiconductor Products.

TUNG-SOL ELECTRIC INC., Newark 4, N. J. Sales Offices: Atlanta, Chicago, Columbus, Culver City (Los Angeles), Dallas, Denver, Detroit, Newark, Seattle.

TUNG-SOL®

RADIO AND TV TUBES

You Can Build a Reputation On Tung-Sol Quality

YOU CAN BUILD A Professional HIGH FIDELITY SOUND SYSTEM

WITH
TECH-MASTER
AMPLIFIER and
PRE-AMPLIFIER Kits

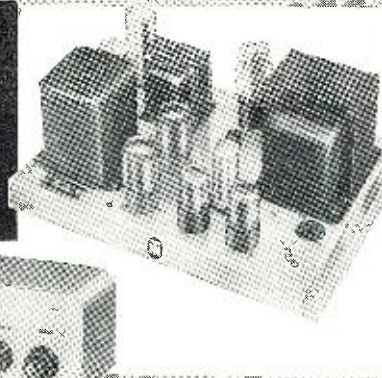

The finest components obtainable are easily assembled by following the complete step-by-step pictorial diagrams.

Your home assembled Tech-Master Amplifier and Pre-Amplifier Kits will be of the highest professional quality with a frequency range of 8 to 100,000 cps at less than 1% distortion for normal listening levels.

At All Leading Radio Parts Jobbers and Sound Dealers



Literature Upon Request

TECH-MASTER CORPORATION
75 Front Street, Brooklyn 1, N. Y.

DELUXE UL* WILLIAMSON TYPE 20 WATT AMPLIFIER KIT: Famous Williamson circuit with modifications for increased undistorted power output. Uses famous make, specially wound quality output transformer. All sockets, terminal strips and connectors are riveted to chassis, ready for wiring.
MODEL TM 15A Net Price: **\$49.95**

Ultra linear operation through use of screen-tapped primary output transformer.

DELUXE 2-CHANNEL PREAMPLIFIER-EQUALIZER KIT with CATHODE FOLLOWER OUTPUT: Provides complete equalization for virtually all recording characteristics now employed. Input channels for radio or TV tuner, crystal or magnetic pickup, tape recorder or other signal sources. Independent bass and treble boost and attenuation controls. Cathode follower output permits remote control operation without 1% frequency loss.
MODEL TM 15P Net Price: **\$19.95**

NEW EICO PROBES*

SCOPE PROBES



SCOPE DEMODULATOR PROBE
KIT \$3.75 WIRED \$5.75

LOW CAPACITY PROBE
KIT \$3.75 WIRED \$5.75

DIRECT PROBE
KIT \$2.75 WIRED \$3.95

SPECIAL . . . All 3 Scope Probes
KIT \$9.95 WIRED \$14.95

VTVM PROBES

VTVM RF PROBES
KIT \$3.75 WIRED \$4.95

PEAK-TO-PEAK PROBES
KIT \$4.95 WIRED \$6.95

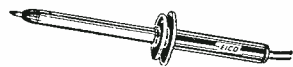

Sensational High Voltage Probe

Model HVP-2 . . . ONLY \$4.95

© 54 Extends range of VTVMs & VOMs to 30 KV *pat. pend.



Write for FREE Catalog RP-1

ELECTRONIC INSTRUMENT CO., INC.
84 Withers Street • Brooklyn 11, N. Y.

when there's a soldering job to be done...



On industrial assembly lines
... in home workshops ...
in electronic labs ... for
production, repair,
maintenance ... the
world's most versatile
family of pencil soldering
irons is on the job,
doing a better job! No
wonder they're called
"Ungar's Little Angels"!

* Interchangeable tips
for every soldering need
from repair to high-
speed production
soldering.



Feather-light,
designed for
hard-to-reach
jobs.



Write for
Catalog U-15

UNGAR ELECTRIC TOOLS, INC.
P. O. Box 372, Venice, California

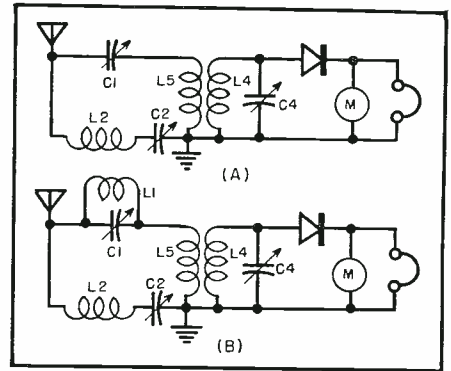

Fig. 2. (A) Simplified version of the circuit of Fig. 1. (B) A derivative circuit. See author's explanation in the article.

However, with C_1 tuned for maximum at the carrier of our key station, enough blocking action (at 1430 kc.) remains so that when this blocking action is combined with the shunting of the L_2 - C_2 circuit, the key station's carrier comes through with no interference.

The derivation of the circuit of Fig. 1 from those of Figs. 2A and 2B is clear. In Fig. 1, L_3 and L_4 are individually shielded and capacitively coupled. This was done to permit control of the amount of coupling. Coils L_2 , L_3 , and L_4 are wound on coil forms $1\frac{1}{2}$ inches in diameter. They are closewound with #28 enamel-covered wire and the coils are $1\frac{1}{8}$ " long. Coil L_5 is 25 turns of #40 wire wound $\frac{1}{4}$ " from the bottom of L_3 . There is more current output with the circuit of Fig. 1 than with either of the other two circuits where L_5 was of the same dimensions as L_4 .

L_1 is a coil $1\frac{1}{4}$ " in diameter, of about 100 turns, wound on polystyrene strips. It is the only commercial coil in the tuner. Good shielding of the coils indicated as shielded, L_2 , L_3 , L_4 , and L_5 , and good bonding to ground are essential to the correct operation of this tuner.

Experimentation may be required before the correct antenna is determined. Too large an antenna may be worse than one that is too small as it will pick up a lot of the local station carrier. The one used at the station was an FM antenna which had been put up when the station had an FM transmitter. It proved to be quite satisfactory.

As the diagram of Fig. 1 shows, the Model 705 "Sensitrol's" meter indicating needle is the contact arm of the relay. The rectified current of the received carrier flows through the meter. With carrier failure the current goes to zero and the needle moves over to the zero position where a red pointer is set. When the needle reaches this point, a permanent magnet pulls the needle into contact with it, closing the audio circuit. When the carrier returns, the program is heard until the operator releases the contact and the needle returns to its current-indicating position. Two audio transformers were used to cut down on hum pick up as the tuner is placed next to the power pack of our G-E limiter-amplifier. If you have no such problem, one transformer is adequate.

Remember QUALITY CANNOT BE UNDERSOLD This is our 34th YEAR as RADIO PARTS Distributors

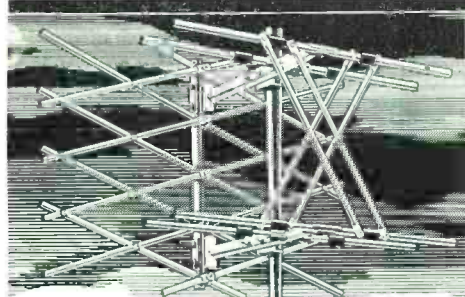

Here's the ideal "all channel" antenna for fringe and far fringe reception
THE NEW RADELCO

DRAGNET

MODEL DN2 FOR VHF - UHF

with the Sensational Diamond Back Reflectors

- Completely rejects interference from both back and sides
- Eliminates co channel interference
- Front to back ratio far surpasses any other antenna on the market.
- Superior all-channel gain
- Completely pre assembled.

The Dragnet Has Been Thoroughly Field Tested

\$34.95 LIST



\$20.79
DEALER PRICE



CONICAL TV ANTENNA

10 Element conical rugged through-out. Only **\$3.95**

Double bay array, with stacking bars **\$7.25**

4 Bay array, with harness and stacking bars **\$14.95**



300 OHM TWIN LEAD

55 Mil, 100 ft. **\$1.59**
1000 ft. **985**

TV MASTS AND HARDWARE

- Bargain Chimney Mount. Net **\$1.49**
Vent Mount **\$1.89**
Stainless Steel Chimney Mount. **\$2.50**
Net
- Twin lead ins. each **3c**
Mortar nail insulator. each **8c**
Mast ins. each **15c**
Ton foot mast. Seamless, expanded end, sturdy enough for the largest arrays. **\$2.39**
Only 5 ft. DURABLE MAST, heavy gauge 1 1/2" diam, with interlocking end. Slip two sections together for a ten-footer. 5 sections - 25 ft. Each section **\$1.25**

- 20 Ga., 80 Mil, 100 ft. **1.89**
1,000 ft. **16.95**
- UHF TUBULAR 300 OHM LINE, 1,000 ft. **\$29.50**
- 100 ft. **\$3.95**
- All Channel Foam Line, 100 ft. for \$6.95. 50 ft. for \$3.95.
- FOUR CONDUCTOR**
Rotor Cable Clear or Brown. Very Special, 1,000 ft. **\$14.95**
100 ft. **\$1.95**

PREMIER Unconditionally Guarantees All Tubes For One Full Year VERY BEST BRANDS AVAILABLE FOR IMMEDIATE DELIVERY. INDIVIDUALLY BOXED.

0A4G 1.19	6AC5GT .89	6F5GT .59c	6X8 1.29	12B7H .89	35Y4 .95c
0Z4 59c	6AC7 1.49	6F6GT .59c	6Y6G .69c	12B7 .89	35Z3 .69
0Z40 .79	6AF4 1.76	6F7 1.59	6Z4/84 .79c	12B7Z .119	35Z4 .69
1A5GT .79	6AG5 .99	6F8C .159	7A4 .95	12F5GT .69	35Z5 .59
1A7GT .79	6AG7 1.49	6GG .95	7A5 1.19	12I6 .89	35/51 .79
1B3GT .95	6A16 1.89	6HG6T .89	7A6 .89	12J5GT .69c	37 .37
1B5 .29c	6A15 2.95	6J5GT .59	7A2 .79c	12K7GT .69c	38 .95c
1H4 .59	6AK5 .89	6J6 .79	7B4 .89	12K8 .89	38 .88c
1H5GT .59	6AK6 1.19	6J6 .79	7B4 .89	12Q7GT .89	39/44 .88c
1J6GT .59	6AL5 .69c	6J7G .59	7B5 .89	12S8 .89	41 .89c
1L4 .129	6A05 .69c	6J8G .119	7B6 .89	12S47GT .69	42 .69c
1L6 .129	6A06 .79	6K5GT .89	7B7 .89	12S07 .95	43 .95c
1L4A .119	6A07 .119	6K6GT .59	7B8 .89	12S5GT .69	45 .69c
1L6A .119	6AR5 .79	6K7GT .89	7C4 .129	12S7F .95	45Z5 .69
1L6C5 .69	6AT6 .59	6K8GT .119	7C5 .89	12S7G .89	46 .69
1L6C6 .119	6A55 .89	6L5G .95	7C6 .79c	12S7GT .89	47 .89c
1L6S .119	6A5GT .129	6L6G .139	7C7 .79c	12S7JGT .69	47 .69
1L6T .119	6A06 .59	6L6GA .119	7E5 .79c	12S7KGT .69	50A5 .95
1L4H .119	6AV5GT .89	6L7 .119	7E6 .79c	12S7LGT .95	50B5 .69c
1L4N .119	6AV6 .59	6N6G .129	7E7 .79c	12S7MGT .95	50C5 .69c
1N5GT .79c	6AX4 .69	6N7GT .119	7F7 .89	12S7N .95	50C6G .129
1P5GT .79c	6AX5 .79	6P5GT .69	7F8 .89	12S7O .95	50L6 .79
1Q5GT .79c	6AX6 .69	6Q7GT .59	7G7 .119	12S7RGT .95	50M5 .89
1R5 .95	6B5GT .89	6R7GT .89	7H7 .119	14A7 .95	50V6 .95
1S4 .95	6B4G .129	6S4 .59	7I7 .119	14A7F .95c	57 .79c
1S5 .69c	6B8GT .119	6S7GT .119	7L7 .79	14B6 .89	70L7 .149
1T4 .69c	6BA6 .59	6S8GT .69c	7N7 .69	14B6 .89	70L7GT .79c
1U4 .59	6BA7 .89	6SA7GT .69c	7Q7 .79	14C5 .119	71A .79c
1U5 .59	6A06 .59	6S07 .79	7R7 .119	14X7 .95c	75 .69
1V2A .89c	6BD5GT .89	6SD7GT .99	7T7 .89	14Y7 .95c	77/6D6 .95
1X6 .69c	6BF5 .59	6SF5 .59	7U7 .79	14F8 .129	80 .69
2A7 .89	6BF6 .69c	6SG7 .69c	7V7 .119	14H7 .95	80 .69
2B3 .89	6B6G .1.89	6SH7GT .69	7X7 .79c	14J7 .119	83 .149
2B7 .89	6B6G .1.89	6S07 .79	7Y7 .79c	14K7 .119	84/6Z4 .69
2Z5 .89	6B16 .69c	6S1GT .79	7Z4 .89	19B6G .1.89	85 .79
2X2/879 .79	6B16 .69c	6S2GT .79	7Z4 .89	19B6G .1.89	VR90 \$1.19
3F4 .129	6B7 .119	6S3GT .79	7Z4 .89	19B6G .1.89	VR150 .29c
3Q4 .69	6B7 .119	6S4GT .79	7Z4 .89	19B6G .1.89	VT52 .149
3Q5GT .89	6B7 .119	6S5GT .79	7Z4 .89	19B6G .1.89	117L7 .149
3S4 .69	6B8G .1.19	6S6GT .79	7Z4 .89	19B6G .1.89	117N7 .149
3V4 .95	6B8G .1.19	6S7GT .79	7Z4 .89	19B6G .1.89	117P7 .149
5T4 .129	6B8G .1.19	6S8GT .79	7Z4 .89	19B6G .1.89	117S7 .149
5U4G .59	6B8G .1.19	6S9GT .79	7Z4 .89	19B6G .1.89	117T6 .149
5V4G .59	6B8G .1.19	6S0GT .79	7Z4 .89	19B6G .1.89	117U6 .149
5W4 .59	6B8G .1.19	6S1GT .79	7Z4 .89	19B6G .1.89	117V6 .149
5Y3GT .49	6B8G .1.19	6S2GT .79	7Z4 .89	19B6G .1.89	117W6 .149
5Y4G .59	6B8G .1.19	6S3GT .79	7Z4 .89	19B6G .1.89	117X6 .149
5X4G .97c	6B8G .1.19	6S4GT .79	7Z4 .89	19B6G .1.89	117Y6 .149
5Z3 .89	6B8G .1.19	6S5GT .79	7Z4 .89	19B6G .1.89	117Z6 .149
6A7 .89	6B8G .1.19	6S6GT .79	7Z4 .89	19B6G .1.89	117A7 .149
6A7GT .129	6B8G .1.19	6S7GT .79	7Z4 .89	19B6G .1.89	117B7 .149
6B4 .69	6B8G .1.19	6S8GT .79	7Z4 .89	19B6G .1.89	117C7 .149
6A87 .119	6B8G .1.19	6S9GT .79	7Z4 .89	19B6G .1.89	117D7 .149
				19B6G .1.89	117E7 .149
				19B6G .1.89	117F7 .149
				19B6G .1.89	117G7 .149
				19B6G .1.89	117H7 .149
				19B6G .1.89	117I7 .149
				19B6G .1.89	117J7 .149
				19B6G .1.89	117K7 .149
				19B6G .1.89	117L7 .149
				19B6G .1.89	117M7 .149
				19B6G .1.89	117N7 .149
				19B6G .1.89	117O7 .149
				19B6G .1.89	117P7 .149
				19B6G .1.89	117Q7 .149
				19B6G .1.89	117R7 .149
				19B6G .1.89	117S7 .149
				19B6G .1.89	117T7 .149
				19B6G .1.89	117U7 .149
				19B6G .1.89	117V7 .149
				19B6G .1.89	117W7 .149
				19B6G .1.89	117X7 .149
				19B6G .1.89	117Y7 .149
				19B6G .1.89	117Z7 .149
				19B6G .1.89	118A7 .149
				19B6G .1.89	118B7 .149
				19B6G .1.89	118C7 .149
				19B6G .1.89	118D7 .149
				19B6G .1.89	118E7 .149
				19B6G .1.89	118F7 .149
				19B6G .1.89	118G7 .149
				19B6G .1.89	118H7 .149
				19B6G .1.89	118I7 .149
				19B6G .1.89	118J7 .149
				19B6G .1.89	118K7 .149
				19B6G .1.89	118L7 .149
				19B6G .1.89	118M7 .149
				19B6G .1.89	118N7 .149
				19B6G .1.89	118O7 .149
				19B6G .1.89	118P7 .149
				19B6G .1.89	118Q7 .149
				19B6G .1.89	118R7 .149
				19B6G .1.89	118S7 .149
				19B6G .1.89	118T7 .149
				19B6G .1.89	118U7 .149
				19B6G .1.89	118V7 .149
				19B6G .1.89	118W7 .149
				19B6G .1.89	118X7 .149
				19B6G .1.89	118Y7 .149
				19B6G .1.89	118Z7 .149
				19B6G .1.89	119A7 .149
				19B6G .1.89	119B7 .149
				19B6G .1.89	119C7 .149
				19B6G .1.89	119D7 .149
				19B6G .1.89	119E7 .149
				19B6G .1.89	119F7 .149
				19B6G .1.89	119G7 .149
				19B6G .1.89	119H7 .149
				19B6G .1.89	119I7 .149
				19B6G .1.89	119J7 .149
				19B6G .1.89	119K7 .149
				19B6G .1.89	119L7 .149
				19B6G .1.89	119M7 .149
				19B6G .1.89	119N7 .149
				19B6G .1.89	119O7 .149
				19B6G .1.89	119P7 .149
				19B6G .1.89	119Q7 .149
				19B6G .1.89	119R7 .149
				19B6G .1.89	119S7 .149
				19B6G .1.89	119T7 .149
				19B6G .1.89	119U7 .149
				19B6G .1.89	119V7 .149
				19B6G .1.89	119W7 .149
				19B6G .1.89	119X7 .149
				19B6G .1.89	119Y7 .149
				19B6G .1.89	119Z7 .149
				19B6G .1.89	120A7 .149
				19B6G .1.89	120B7 .149
				19B6G .1.89	120C7 .149
				19B6G .1.89	120D7 .149
				19B6G .1.89	120E7 .149
				19B6G .1.89	120F7 .149
				19B6G .1.89	120G7 .149
				19B6G .1.89	120H7 .149
				19B6G .1.89	120I7 .149
				19B6G .1.89	120J7 .149
				19B6G .1.89	120K7 .149
				19B6G .1.89	120L7 .149
				19B6G .1.89	120M7 .149
				19B6G .1.89	120N7 .149
				19B6G .1.89	120O7 .149
				19B6G .1.89	120P7 .149
				19B6G .1.89	120Q7 .149
				19B6G .1.89	120R7 .149
				19B6G .1.89	120S7 .149
				19B6G .1.89	120T7 .149
				19B6G .1.89	120U7 .149
				19B6G .1.89	120V7 .149
				19B6G .1.89	120W7 .149
				19B6G .1.89	120X7 .149
				19B6G .1.89	120Y7 .149
				19B6G .1.89	120Z7 .149
				19B6G .1.89	121A7 .149
				19B6G .1.89	121B7 .149
				19B6G .1.89	121C7 .149
				19B6G .1.89	121D7 .149
				19B6G .1.89	121E

**this great all-channel antenna discovery
is smashing sales and performance records
in every TV area!**

Single bay
SUPER RAINBOW
model no. 331

the
CHAMPION

RAINBOW*

brilliant black-and-white performance —
and really ready for COLOR!

these 3 revolutionary, power-packed
design features — found in no
other antenna today!

1. New spacing formula: Radical new spacing arrangements between the directors and reflectors has, for the first time, extended the full efficiency and high gain of the basic narrow band Yagi over the *full width of an entire VHF band.*

2. New "triple power" High Band directors and reflectors: Three-section directors and reflectors, with insulated segments, provide combined power of three High Band Yagis, operating side by side, in phase.

3. New "inter-mix" design: Combines — into one single antenna — two separate, *independent* sets of directors and reflectors, one for High Band, one for Low Band. Each parasitic system operates *only* on its own band. Fullest efficiency — no compromise design.

PLUS Channel Master's patented, super-gain TRI-POLE . . . the unique triple-power dipole that made the Champion America's most wanted antenna.

Write for complete technical literature

Stacked
RAINBOW
model no. 330-2

CHANNEL MASTER
*creative
engineering*

Here's how the RAINBOW out-performs the famous Champion:

		CHANNEL	2	3	4	5	6	7	8	9	10	11	12	13
Gain Over	1-Bay RAINBOW	0	0	0	+1	+2	+3	+2.5	+1	+5	+5	+1.5	+2	
	1-Bay Champion	+1	+1	+1.5	+2.5	+3.5	+3.5	+3	+2	+1.5	+2	+3.5	+4	
		DB	DB	DB	DB	DB	DB	DB	DB	DB	DB	DB	DB	DB
Gain Over	Stacked RAINBOW	+1.5	+2	+1.5	+1.5	+2	+5	+5	+0	+0	+0	+1	+1	
	Stacked Champion	+2	+2.5	+3	+3	+4	+5	+1	+1	+2	+2	+2.5	+3	
		DB	DB	DB	DB	DB	DB	DB	DB	DB	DB	DB	DB	DB

horizontal
polar pattern
(relative
voltage)

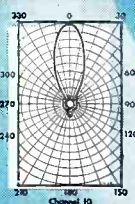

for fringe and super-fringe areas:

Super Rainbow, model no. 331

\$37⁵⁰ list

*stacked Super Rainbow,
model no. 331-2*

\$75⁷⁰ list

for suburban and near-fringe areas:

Rainbow, model no. 330

\$23⁶⁰ list

stacked Rainbow, model no. 330-2

\$48⁶⁰ list

something new in indoor antennas

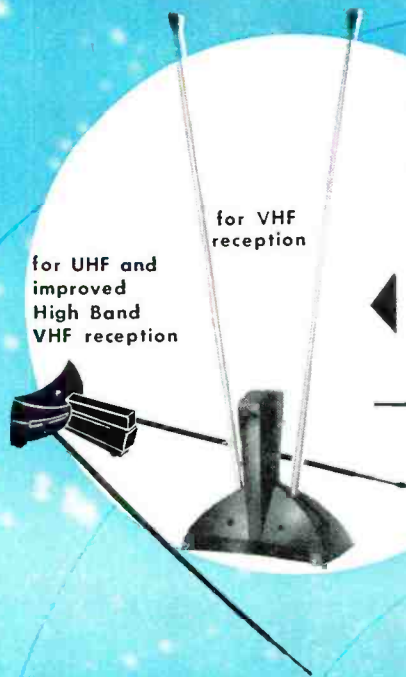

for UHF and improved High Band VHF reception

for VHF reception

- features 3 telescoping sections.
- tilt-proof polystyrene base — cannot tip over.
- handsomely packaged for display.

the ALL-VU*

*all VHF . . . all-UHF
the only indoor antenna with this "2-Way" feature.

model no. 381 \$6⁹⁵ list

the PRE-VU

for all-channel VHF reception only.

model no. 380

\$5⁹⁵ list

brings you today's **5**
newest installation ideas

for . . . more effective installations
. . . greater customer satisfaction
. . . higher profits for you!



TV ROTATOR

with features found in no other rotator today:

- flexible worm gear, built-in thrust bearing.
- removable motor, electrical and mechanical stops.
- weatherproof, lightweight, strong.
- straight-thru mast mounting, built-in chimney mount.
- extremely high torque.

model no. 9521, \$49⁹⁵ list

model no. 9520, without directional indicator, \$44⁹⁵ list



Beautifully-styled cabinet has great consumer appeal — is smallest on market (2³/₄" x 4"). Finger-tip control bar.

ALUMast

Aluminum Masting.
The new idea in antenna masting—

can never rust!

- in telescoping sections
- in swaged 5, 10, and 14 foot sections

Lightweight ALUMast is 1/3 the weight of steel, making it so easy to install — it swings right up! Stronger than steel, ALUMast is easier to stock and actually more economical.



SELECTENNA COUPLING SYSTEM

permits unlimited antenna combinations with only one transmission line!

- for the first time, you can tie together an unlimited combination of antennas, including separate antennas operating on the same band.
- ideal for areas currently using rotators, manually-operated selector switches, and "omni-directional" antennas.

list price:

\$542

each including hardware and wire for joining couplers.

This interlocked stack consists of 4 antenna couplers and 1 Hi-Lo coupler; joins 4 antennas.

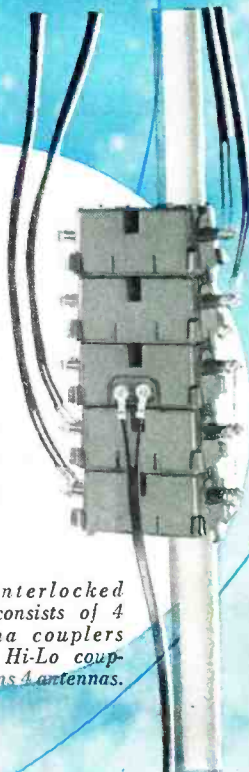

CHANNEL MASTER CORP. ELLENVILLE, N. Y.

WORLD'S LARGEST MANUFACTURER OF TELEVISION ANTENNAS



27" Wired CHASSIS
for CUSTOM BUILDING
27 TUBES, including CRT
with or without REMOTE CONTROL



CHASSIS and CRT—\$239
plus 10% Tax
In Kit Form . . . \$199

This De Luxe Transvision Chassis is ideal for fringe area. UHF-VHF reception. . . Has super-sensitivity and stability. . . Keyed AGC . . . 27 tubes, including CRT and 3 rectifier tubes. Available with Remote Control and dual sound system for \$69 additional.

CRT TESTER-REACTIVATOR
\$19.95

- Completely checks picture tubes for emission and shorts.
- Reactivates many tubes in which emission has fallen off from either use or standing in a carton.

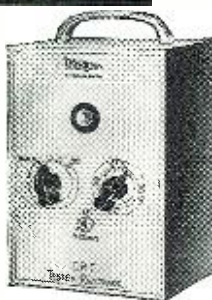

CRT SPARKER
\$19.95

Eliminates Electrical Leakage by the application of 15,000 volts of RF

Also—CRT TESTER-REACTIVATOR-SPARKER; 3 instruments in one for only \$34.95 net.

10 DAY TRIAL: Try these Transvision TESTERS for 10 days. Then, if you are not 100% satisfied, you may return them. Your purchase price, less 10% (our cost of handling and repacking) will be promptly refunded.

TRANSVISION, INC.
NEW ROCHELLE, N.Y.

TRANSVISION, INC., New Rochelle, N. Y., Dept. RN-1
() Send _____

() Enclosed find \$_____ deposit. Balance C.O.D.
I accept your 10 Day Trial terms.

Name _____

Address _____

City _____ State _____

My Jobber is _____
JOBBER INQUIRIES INVITED

Electronic Butler
(Continued from page 49)

tor in place of the electrolytic; however, the writer chose the electrolytic because of its small physical size, and because, in this application, the length of the cycle is not critical.

After the adjustment has been completed, the assembly may be slipped into the metal box which should be provided with a 7/8 inch hole fitted with a standard BX bushing and a rubber grommet for wires to the doorbell wiring as shown in Fig. 5. A length of 3-wire #14 BX cable is used to connect the "Butler" to the house wiring, and should be wired as shown in the connecting diagram, Fig. 4.

The location of the timer will depend on the particular layout of the house wiring. However, if it is necessary to install the timer where it is visible, it should be flush-mounted, and the front

cover fitted with a blank cover plate to match the switch covers used in the room. The box should be fitted with mounting ears, and mounted in the same manner as standard wall switch boxes.

Other jobs for the "Electronic Butler" can be found around the average home, such as controlling garage, stairway, or yard lights. The starting relay can be controlled from a variety of places such as the front gate, garage, or workshop. All indoor control wiring may be run with doorbell wire, but outdoor wiring should be done with weatherproof wire such as used for intercommunication lines.

Application of this unique circuit need not be confined to operating the porch light. By substituting a paper capacitor for C_3 , the length of the cycles can be made uniform, making the device suitable for a number of other intermittent timer applications where economy during idle periods is worth considering.

—30—

EQUALIZER-PREAMP MODIFICATIONS

By ARTHUR J. ROSE

Indicated the success of the Equalizer-Preamp described in June 1953 issue of RADIO & TELEVISION NEWS. Numerous recent requests for modification of the equalizer to include the RIAA¹ curve are answered in the following. Other changes in the circuit have not been necessary nor desirable.

Since the RIAA and the Col LP curves both derive their bass sections from the shunting of a resistor across the feedback capacitor, thumps arise during switching due to changing d.c. levels unless an additional blocking capacitor and a high resistance charging resistor are employed. Not shown in the original article, these extra components are given in the diagram of Fig. 1.

C_{18} is dictated by the maximum turnover frequency to be used. If, for example, the maximum turnover is to be 800 cps, then C_{18} has to be .002 μ fd. Switch positions for 800 cps require no additional capacitance, but an additional .001 μ fd. is needed for 500 cps and .002 μ fd. for 400 cps. The original equalizer switch used such an arrangement with the exception of the Col LP position. There, the shunting resistor effectively produced the correct curve in spite of the high turnover and thereby saved the expense of an additional .001 μ fd. capacitor.

Because the modification replaces the old RCA curve, the 800 cps turnover is no longer needed and C_{18} is increased to the correct value for 500 cps turnovers. The Col LP position uses a different shunting resistance than originally shown for reasons previously inferred.

C_{20} and R_{35} prevent switching thumps. Additional 4.7 megohm charging resistors are employed in the de-emphasis side of the switch to insure completely noiseless switching.

Readers are again cautioned to insure

¹"The Curve That Conforms", Radio & Television News, July 1954

correctness of capacitor values before using them in equalizers and other frequency correcting networks. Ceramic disc capacitor tolerances are catalogued as $-0 +100\%$. Small mica capacitors should therefore be used where bridging facilities are unavailable.

—30—

Fig. 1. Circuit changes to be incorporated in the equalizer-preamp of June, 1953 to provide equalization for new RIAA curve.

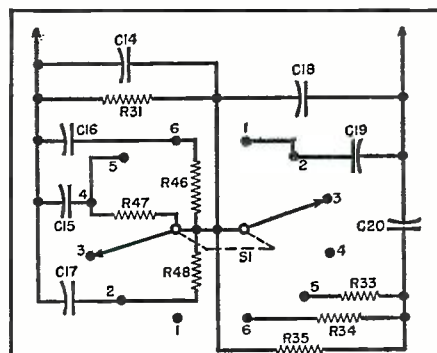

- R_{31} —100,000 ohms (no change)
 - R_{33} —510,000 ohms (was 47,000)
 - R_{34} —1 megohm (was 3.3 megohm)
 - R_{35} —4.7 megohm (was 3.3 megohm)
 - R_{46} , R_{47} , R_{48} —4.7 megohm, 1/2 w. res. (not in original)
 - C_{14} —50 μ fd. (no change)
 - C_{16} —0.01 μ fd. (no change)
 - C_{17} —750 μ fd. (was 500 μ fd.)
 - C_{18} —600 μ fd. (was 200 μ fd.)
 - C_{19} —0.033 μ fd. (was .002 μ fd.)
 - C_{20} —0.01 μ fd. (was .002 μ fd.)
 - C_{20} —.02 μ fd., 400 v. (was .002 μ fd., 500 v. ceramic)
 - S_1 —D.p. 6-pos. switch
- POS. CURVE
1—Eur., Early Amer. 78's, London frr 78
2—AES (pre-RIAA)
3—Amer. 78's, old RCA 33 1/3's
4—NARTB (pre-RIAA)
5—Col. LP's
6—RIAA, RCA "Ortho", new NARTB, new AES



JET-HELIX[®]

"The RAINBOW Antenna"

a radical new flat plane helical concept
for VHF-UHF black and white
or COLOR reception

Compare

its revolutionary microwave helix design that delivers highest signal magnitude on all channels with the least amplified noise—the same helical configuration used in amateur and commercial reception where the ultimate in high gain and sharp directivity is vital.

Compare

its preassembled jet-action construction with sensational new "Hi-Tension" aluminum element brackets that slash assembly time to seconds. You don't even need a screw driver because there is no hardware to tighten. It's automatic!

Compare

its tremendous consumer advertising support that presells your customers! newspaper ad mats, direct mail, displays, streamers, radio and television, movie commercials, national publicity.

Compare

its top-notch front-to-back (up to 23 db) and front-to-side (up to 20 db) ratios that reject co-channel and adjacent channel interference!

Compare

its matchless Alcoa aluminum construction!



Compare

the Jet Helix by any standards known and you will agree with thousands of dealers—the JET HELIX is the "hottest" antenna in the industry, both in performance and sales!

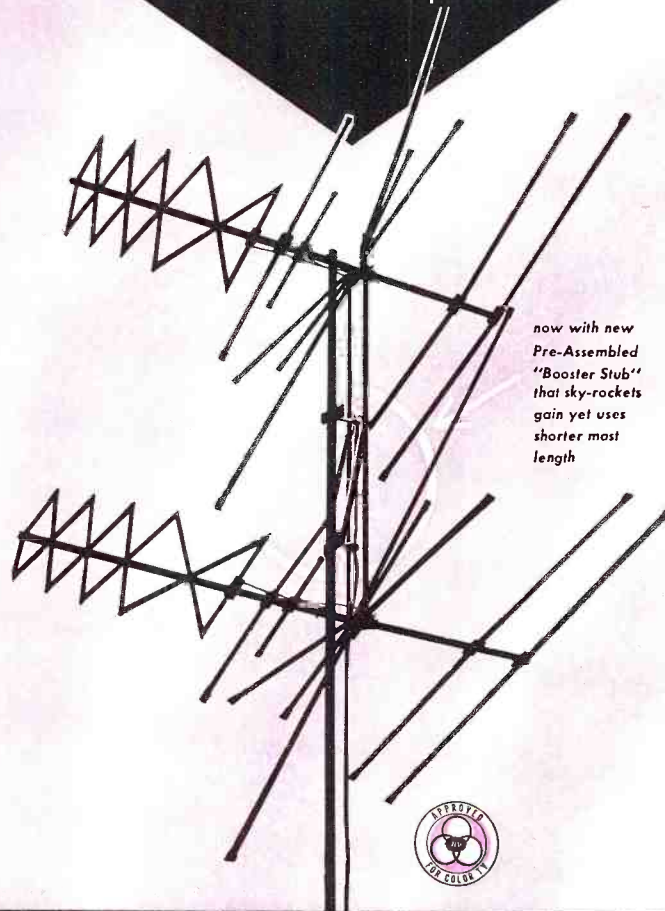

now with new Pre-Assembled "Booster Stub" that sky-rockets gain yet uses shorter mast length



INCREDIBLE MICROWAVE HELICAL DESIGN!

ANTENNA	2	3	4	5	CHANNELS				10	11	12	13
					6	7	8	9				
"JET-HELIX" JET9135	8.3	8.6	9.	9.5	9.4	15.2	15.8	15.5	15.	14.8	15.1	15.3
"JET-HELIX" JET9135-5	9.2	10.5	11.1	10.5	9.8	13.5	14.4	14.8	15.2	15.5	15.5	15.
"SUPERJET" JET213S	6.8	8.3	9.5	8.8	8.6	10.5	11.2	12.	13.5	13.8	13.6	12.9
"SUPER POWERJET" JET213S-5	7.5	9.5	11.2	10.5	9.3	11.8	12.2	12.8	13.2	13.3	14.2	14.
"DODO" Screen Type REFLECTOR	4.75	4.5	7.2	7.1	7.	11.	11.2	11.8	11.5	11.1	12.1	12.
"SUPER DODO" Screen Type REFLECTOR	6.3	6.8	8.8	7.8	7.5	9.5	11.2	11.8	12.	11.1	12.1	12.
Broad Band Yagi with Phasing Stubs	4.3	5.7	4.5	7.1	9.	13.	14.	13.5	14.	13.	14.	15.
Inline Yagi with Phasing Stubs	5.2	5.5	6.	8.	8.	11.5	9.5	10.	9.	11.	11.5	11.8
Inline Yagi with Triple Dipole	6.25	6.5	8.7	8.6	9.	11.5	11.7	11.8	11.5	11.1	13.1	13.5
Super-Inline Yagi with Triple Dipole	6.75	7.	10.2	10.3	11.	11.5	12.2	12.8	13.5	13.1	14.6	15.5

SKY-ROCKETS GAIN!

COMPARE THE DIFFERENCE!

For your "pot of gold" follow the JFD RAINBOW Antenna!

Compare its S/N Figure of Merit!
JFD JET-HELIX—57.85%*

Model	Bays	List
JET 913	SINGLE	25.50
JET 913S	STACKED	52.50
JET 913S-5	HALF WAVE STACKED	55.00

The Signal to Noise Figure of Merit sums up the major individual characteristics of an antenna in one concise value for quick and accurate comparison. Read the S/N Figure of Merit analysis for details.

gain represents that over 1/2 wave reference folded dipole

Horizontal Pattern

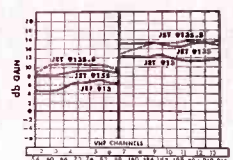
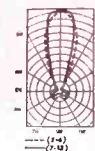



Now!

KAY-TOWNES

brings you complete

Protection from the Rear

Plus

Quick Rig!

THE **first**
SNAP-OUT

ANTENNA WITH THE
EXCLUSIVE  DOUBLE LOCK
FEATURE!

Boom also folds to take less room in storage and for ease of installation. Sure-grip mast clamp holds in gale-force winds... will not slip or crush.

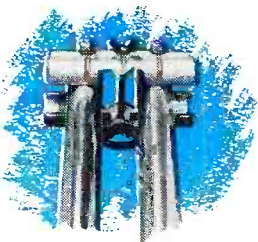

Exclusive with KAY-TOWNES Elements will not droop, sag or fold up on a Kay-Townes Antenna... they're nested and double locked in position to stay in position.

New features that make the K-T "REAR-GUARD" America's most advanced TV Antenna!

- ★ Completely Preassembled, it's mechanically safe!
- ★ It snaps in place to stay in place! Elements are double locked in position! A K-T Exclusive!
- ★ No bolts or nuts to tighten on elements!

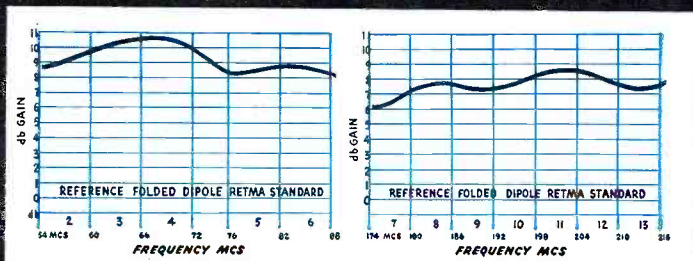

Front to back ratio is better than 25/1 forward lobe - 30° or better standing wave ratio 1.2:1 average.



RADIATION CURVE REPRESENTING ALL VHF CHANNELS
Over 20 to 1 ratio on ALL Channels

For Quality...

Manufactured and distributed in Canada by Delhi Metal Products, Ltd. Delhi, Ontario

Patents applied for

REAR GUARD

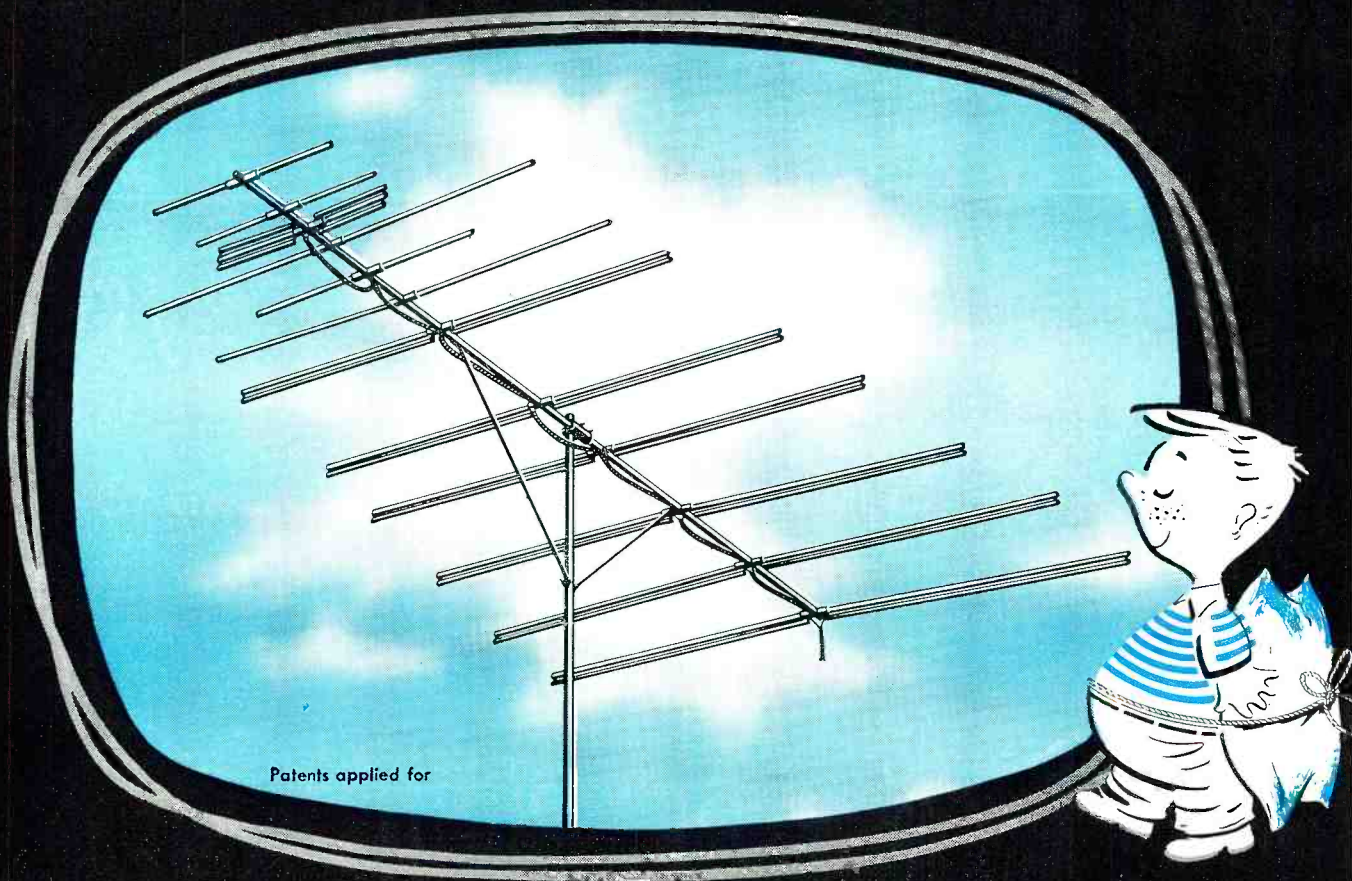

THE ANTENNA DESIGNED TO REJECT UNWANTED SIGNALS FROM REAR AND SIDES!

In areas where many local stations or stations from near-by cities interfere with reception, ordinary antennas cannot filter out unwanted signals from sides and rear ... **BUT** the KAY-TOWNES REAR-GUARD, with a front to back ratio far in excess of 20 to 1, is designed for *this* particular job ... to give quality reception even in problem areas.

Add to the REAR-GUARD'S pin point selectivity such exclusive K-T features as double locked and nested elements that cannot droop or sag, Sure-Grip Mast Clamp that holds in gale-force winds without slipping or crushing, extra rigid construction and wood dowel pins and crimped ends that relieve metal fatigue due to vibration ... they all add up to *America's most wanted TV Antenna.*

... for Performance look to KAY-TOWNES!

The First Name in TV Antennas

KAY-TOWNES

ANTENNA COMPANY

BOX 593B, ROME, GEORGIA

*Use the K-T Line
of television
accessories*

NOW!

**Step ahead faster
as an
INDUSTRIAL
ELECTRONICS
TECHNICIAN**



**Turn your experience into a
big, new better-paying career!**

Day by day industrial plants are adding more electronic devices — for sorting, counting, checking almost any control job you can name. Cash in on industry's great need for men who can keep these devices in top working order. Make more money, feel more secure, doing work that is second nature to you. With what you already know about electronics you have a long head start in a field just beginning to boom. GET INTO IT RIGHT NOW with the help of

**PRACTICAL INDUSTRIAL
ELECTRONICS LIBRARY**

No long sessions on math or theory! These 4 practical volumes show you how to keep the plant's electronic equipment working . . . how to locate and correct tube and circuit troubles . . . how to install, service, and maintain even brand new equipment without being stumped by new circuits.

- 4 volumes (1390 pp., 1050 illus.); Chute's Electronics in Industry
- Miller's Maintenance Manual of Electronic Control
- Markus & Zeluff's Handbook of Industrial Electronics Circuits
- Henney & Fahnestock's Electron Tubes in Industry

FREE TRIAL—EASY TERMS!

McGraw-Hill Book Co., 327 W. 41 St., NYC 36
Send me the Practical Industrial Electronics Library for 10 days' examination on approval. In 10 days I will send \$2.50, then \$4.00 a month until \$22.50 is paid. (A saving of \$3.50 under the regular price of \$26.00.) Otherwise I will return books postpaid. (Print)

Name

Address

City Zone State

Company

Position

This offer applies in U.S. only.

**Have You Seen
POPULAR ELECTRONICS?
It Is Now on Sale!**

NEW OSCILLATOR CIRCUIT

By LAWRENCE FLEMING, Consultant

FIG. 1A shows an unusually simple oscillator circuit suitable for audio frequencies, which requires no taps on the coil and no chokes. It will operate well with almost any available inductor: a power supply filter choke, a toroid, or even a pair of headphones.

The circuit is a variation of one recently published by J. K. Clapp. It is a grounded-plate Colpitts circuit, with the tube operating in class AB₁. The d.c. path between the cathode and ground is completed by a resistor R₂. The signal loss due to the resistor is not serious, because only 1/4 or less of the total tank circuit voltage appears across the resistor R₂ and the lower capacitor C₂. There is no grid leak in the usual sense. The series grid resistor R₁ is used only to minimize grid current, and does not significantly affect the bias condition of the tube. R₁ may be omitted with a slight loss in output.

This type of oscillator is not an efficient generator of power, but is primarily good at delivering voltage to a high impedance load. The best waveform is obtained by taking the output directly across the tuned circuit, as indicated in Fig. 1A. For more power with poorer waveform, a load can be connected in series with the plate of the tube, for example a pair of headphones for code practice.

Headphone Inductor

Fig. 1B shows an interesting variation in which the tank inductance is furnished by a pair of phones. With a pair of high-impedance phones of the ordinary sort, the capacitor values given will furnish a note of about 1000 cycles. To change the frequency, change the capacitors, but keep the ratio between the two capacitors about the same. Due to the low "Q" of the inductance, this circuit requires about 50 volts on the plate in order to oscillate. With a reasonably high "Q" coil, it will oscillate at any "B" voltage from 10 or 20 on up.

Circuit Characteristics

The greater the "Q" of the tuned circuit, the higher the a.c. output voltage

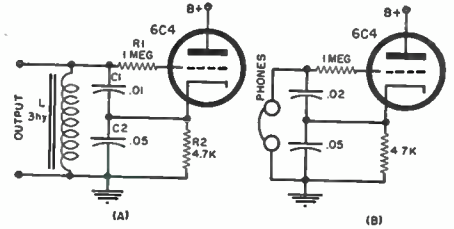

Fig. 1. (A) A new LC oscillator circuit of unusual simplicity. (B) Code-practice version of the circuit of (A) in which the headphones form the tank inductance.

obtained. The a.c. output varies, also, about directly with the applied "B" voltage. For the Fig. 1A circuit, the output was 20 volts r.m.s. across the tuned circuit for a 100-volt "B" supply, and the plate current was 2 milliamperes. The coil L was actually the primary of a midget output transformer rated 1500 ohms, which measured 3 henrys at 1 kc. with a "Q" of 3.5.

The feedback ratio is the ratio of the capacitances C₁/C₂. For ordinary use a ratio of 1/3 to 1/10 is suitable. The output drops with smaller feedback ratios, e.g., 1/10. A ratio of 1/2 is too large; efficiency suffers badly because there is too much signal voltage across the cathode resistor R₂. For best waveform, use a high "Q" inductor L and the smallest feedback ratio that will give reliable oscillation. The output will be low, 1 volt or less. With a good toroidal inductor the ratio can be as small as 1/500. For each feedback ratio there is a value of R₁ which gives maximum output, and for small-signal, low-distortion purposes a larger resistance, e.g., 22,000 ohms, may be better. The feedback ratio has, however, the most effect on the waveform.

Since this circuit operates class AB₁, the plate current increases with the a.c. output. Thus, loading down the tuned circuit will decrease the plate current, instead of increasing it as it does in ordinary class C oscillators.

Practically any tube will work in this circuit, and higher-G_m types will oscillate more easily than the 6C4. -30-

The booster with twice as much gain as ever before.

Regency model DB-550 cascade two-stage booster designed specially for use with cascade front ends.

Regency, world's leading manufacturer of TV accessories including VHF boosters, FM boosters, voltage boosters, UHF converters, chairside TV control, high pass filters and a complete line of high fidelity equipment.

Regency

REGENCY DIVISION, I.D.E.A., INC.
INDIANAPOLIS 26, INDIANA

Technical BOOKS

"PICTURE BOOK OF TV TROUBLES"
by Rider Staff. Published by John F. Rider Publisher, Inc., New York. 70 pages. Price \$1.35. Vol. 1.

This first volume in the new series covers the horizontal a.f.c.-oscillator circuits of a television receiver. This book is the result of hours of painstaking labor on the part of the Rider Laboratories staff and the result provides worthwhile short-cuts for the service technician.

Faulty receivers were checked by means of waveform observation, peak-to-peak and d.c. voltage measurements, and resistance checks—the results were recorded as picture-tube face photos so that all the technician has to do to locate a specific fault is match up the trouble on the CR tube of the set he is servicing with the photo in the book.

Then, by referring to the accompanying text, the technician can localize the receiver fault and make the necessary corrections and adjustments. This first volume is divided into four chapters dealing with pulse-width a.f.c.-oscillator circuit, phase detector-stabilized multivibrator a.f.c.-oscillator circuit, phase discriminator-sine wave oscillator a.f.c. circuit, and phase detector-sine wave oscillator a.f.c. circuit.

* * *

"BASIC TELEVISION PRINCIPLES AND SERVICING" by Bernard Grob. Published by McGraw-Hill Book Company, Inc., 653 pages. Price \$6.00. Second Edition.

This is a completely up-to-date edition of a book which originally appeared in 1949. Written by an instructor at RCA Institutes, the presentation of the material and the plan of the book follows the "course" technique so that the radio technician starting from scratch can cover the entire field by a careful attention to the text material.

Among many practicing technicians, this work is considered to be the most complete and authoritative in the field. The fact that new data and additional material on color receivers is offered in this second edition would seem to make it an even more desirable standby for the shop bookshelf.

In addition to 24 chapters covering all phases of television, there are 25 tables providing such diversified data as TV channel allocations and visual response curves.

Each of the topics discussed by the author is handled in such a way that the essential features are covered first and then the details are added.

The publisher of this volume has made available a series of text-films which have been correlated with the book. They are available for instructional purposes when this volume is used in schools, etc.

—30—

January, 1955

"My new

Magnecorder

is an entertainment thrill!"



says Johnny Desmond

From the faithful recording of children's brightest moments to the exacting recording needs of the professional musician and entertainment star, Magnecord holds its reputation for the finest in tape recording. Johnny Desmond, popular star of TV, radio and recordings, his wife, Ruth, and little Diane and Patti listen to one of the new pre-recorded high-fidelity tapes, reproduced with perfect fidelity on his new Magnecorder M-30. If you've wanted the finest in true, high fidelity recording and reproduction, now you can own a Magnecorder too!

Call or see your Magnecord dealer today. He's listed under "Recorders" in your classified telephone directory. Find out why Magnecord is considered the finest.

magnecord, inc.

the finest name in tape recording

1101 SOUTH KILBOURN AVENUE • CHICAGO 24, ILLINOIS • DEPT RT-1

M-30D

"Cristocrot"

\$339.

Other models
from \$299

The Model
TV-50

GENOMETER

A versatile all-inclusive GENERATOR which provides ALL the outputs for servicing:

A. M. Radio F. M. Radio Amplifiers Black and White TV Color TV

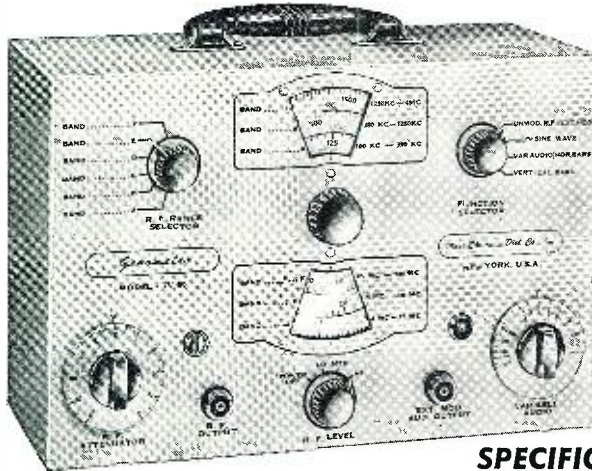

SPECIFICATIONS:

R. F. SIGNAL GENERATOR:

The Model TV-50 Genometer provides *complete* coverage for A.M. and F.M. alignment. Generates Radio Frequencies from 100 Kilocycles to 60 Megacycles on fundamentals and from 60 Megacycles to 180 Megacycles on powerful harmonics. Accuracy and stability are assured by use of permeability trimmed Hi-Q coils. R.F. is available *separately*, modulated by the fixed 400 cycle sine-wave audio or modulated by the variable 300 cycle to 20,000 cycle variable audio. Provision has also been made for injection of any external modulating source.

VARIABLE AUDIO FREQUENCY GENERATOR:

In addition to a fixed 400 cycle sine-wave audio, the Model TV-50 Genometer provides a variable 300 cycle to 20,000 cycle peaked wave audio signal. This service is used for checking distortion in amplifiers, measuring amplifier gain, trouble shooting hearing aids, etc.

BAR GENERATOR:

This feature of the Model TV-50 Genometer will permit you to throw an actual Bar Pattern on any TV Receiver Screen. Pattern will consist of 4 to 16 horizontal bars or 7 to 20 vertical bars. A Bar Generator is acknowledged to provide the quickest and most efficient way of adjusting TV linearity controls. The Model TV-50 employs a recently improved Bar Generator circuit which assures stable never-shifting vertical and horizontal bars.

CROSS HATCH GENERATOR:

The Model TV-50 Genometer will project a cross-hatch pattern on any TV picture tube. The pattern will consist of non-shifting, horizontal and vertical lines *interlaced* to provide a stable cross-hatch effect. This service is used primarily for correct ion trap positioning and for adjustment of linearity.

7 Signal Generators in One!

- ✓ R. F. Signal Generator for A.M.
- ✓ R. F. Signal Generator for F.M.
- ✓ Audio Frequency Generator
- ✓ Bar Generator
- ✓ Cross Hatch Generator
- ✓ Color Dot Pattern Generator
- ✓ Marker Generator

DOT PATTERN GENERATOR (For Color TV)

Although you will be able to use most of your regular standard equipment for servicing Color TV, the one addition which is a "must" is a Dot Pattern Generator. The Dot Pattern projected on any color TV Receiver tube by the Model TV-50 will enable you to adjust for *proper color convergence*. When all controls and circuits are in proper alignment, the resulting pattern will consist of a sharp white dot pattern on a black background. One or more circuit or control deviations will result in a dot pattern out of convergence, with the blue, red and green dots in overlapping dot patterns.

MARKER GENERATOR:

The Model TV-50 includes *all* the most frequently needed marker points. Because of the ever-changing and ever-increasing number of such points required, we decided against using crystal holders. We instead adjust each marker point against precise laboratory standards. The following markers are provided: 189 Kc., 262.5 Kc., 456 Kc., 600 Kc., 1000 Kc., 1400 Kc., 1600 Kc., 2000 Kc., 2500 Kc., 3579 Kc., 4.5 Mc., 5 Mc., 10.7 Mc. (3579 Kc. is the color burst frequency.)

The Model TV-50 comes absolutely complete with shielded leads and operating instructions. Only

\$ 47⁵⁰
NET

SHIPPED ON APPROVAL NO MONEY WITH ORDER — NO C.O.D.

Try it for 10 days before you buy. If completely satisfied then send \$11.50 and pay balance at rate of \$6.00 per month for 6 months. **No Interest or Finance Charges Added!** If not completely satisfied return unit to us, no explanation necessary.

MOSS ELECTRONIC DISTRIBUTING CO., INC.
Dept. D-90, 3849 Tenth Ave., New York 34, N.Y.

Please rush one Model TV-50. I agree to pay \$11.50 within 10 days and to pay \$6.00 per month thereafter. It is understood there will be no finance, interest or any other charges, provided I send my monthly payments when due. It is further understood that should I fail to make payment when due, the full unpaid balance shall become immediately due and payable.

Name

Address

City.....Zone....State.....



Measures 6 1/4" x 9 1/2" x 4 1/2"

Superior's new
Model 670-A

SUPER METER

A COMBINATION VOLT-OHM MILLIAMMETER PLUS
CAPACITY REACTANCE INDUCTANCE AND DECIBEL MEASUREMENTS

SPECIFICATIONS:

D.C. VOLTS: 0 to 7.5/15/75/150/750/1,500/7,500 Volts
A.C. VOLTS: 0 to 15/30/150/300/1,500/3,000 Volts
OUTPUT VOLTS: 0 to 15/30/150/300/1,500/3,000 Volts
D.C. CURRENT: 0 to 1.5/15/150 Ma. 0 to 1.5/15 Amperes
RESISTANCE: 0 to 1,000/100,000 Ohms 0 to 10 Megohms
CAPACITY: .001 to 1 Mfd. 1 to 50 Mfd. (Good-Bad scale for checking quality of electrolytic condensers)
REACTANCE: 50 to 2,500 Ohms, 2,500 Ohms to 2.5 Megohms
INDUCTANCE: .15 to 7 Henries 7 to 7,000 Henries
DECIBELS: -6 to +18 +14 to +38 +34 to +58

ADDED FEATURE:

Built-in ISOLATION TRANSFORMER reduces possibility of burning out meter through misuse.

The Model 670-A comes housed in a rugged, crackle-finished steel cabinet complete with test leads and operating instructions.

\$28⁴⁰
NET



Superior's new
Model TV-11

TUBE TESTER

SPECIFICATIONS:

- ★ Tests all tubes including 4, 5, 6, 7, Octal, Lock-in, Peanut, Bantam, Hearing Aid, Thyatron, Miniatures, Sub-Miniatures, Novals, Sub-minars, Proximity fuse types, etc.
- ★ Uses the new self-cleaning Lever Action Switches for individual element testing. Because all elements are numbered according to pin-number in the RMA base numbering system, the user can instantly identify which element is under test. Tubes having tapped filaments and tubes with filaments terminating in more than one pin are truly tested with the Model TV-11 as any of the pins may be placed in the neutral position when necessary.
- ★ The Model TV-11 does not use any combination type sockets. Instead individual sockets are used for each type of tube. Thus it is impossible

to damage a tube by inserting it in the wrong socket.

- ★ Free-moving built-in roll chart provides complete data for all tubes.
- ★ Newly designed Line Voltage Control compensates for variation of any Line Voltage between 105 Volts and 130 Volts.
- ★ NOISE TEST: Phono-jack on front panel for plugging in either phones or external amplifier will detect microphonic tubes or noise due to faulty elements and loose internal connections.

The model TV-11 operates on 105-130 Volt 60 Cycles A.C. Comes housed in a beautiful hand-rubbed oak cabinet complete with portable cover.

\$47⁵⁰
NET

EXTRA SERVICE—The Model TV-11 may be used as an extremely sensitive Condenser Leakage Checker. A relaxation type oscil-

lator incorporated in this model will detect leakages even when the frequency is one per minute.

SUPERIOR'S NEW MODEL TV-40



C.R.T. TUBE TESTER

★ A complete picture tube tester for little more than the price of a "make-shift" adapter!!

The Model TV-40 is absolutely complete! Self-contained, including built-in power supply, it tests picture tubes in the only practical way to efficiently test such tubes; that is by the use of a separate instrument which is designed exclusively to test the ever increasing number of picture tubes!

EASY TO USE:

Simply insert line cord into any 110 volt A.C. outlet, then attach tester socket to tube base (ion trap need not be on tube). Throw switch up for quality test . . . read direct on Good-Bad scale. Throw switch down for all leakage tests.

★ Tests all magnetically deflected tubes . . . in the set . . . out of the set . . . in the carton!!

SPECIFICATIONS:

- Tests all magnetically deflected picture tubes from 7 inch to 30 inch types.
- Tests for quality by the well established emission method. All readings on "Good-Bad" scale.
- Tests for inter-element shorts and leakages up to 5 megohms.
- Tests for open elements.

Model TV-40 C.R.T. Tube Tester comes absolutely complete—nothing else to buy. Housed in round cornered, molded bakelite case. Only

\$15⁸⁵
NET

**SHIPPED ON APPROVAL
NO MONEY WITH ORDER — NO C.O.D.**

Try any of the above instruments for 10 days before you buy. If completely satisfied then send down payment and pay balance as indicated on coupon. **No Interest or Finance Charges Added!** If not completely satisfied return unit to us, no explanation necessary.

MOSS ELECTRONIC DISTRIBUTING CO., INC.

Dept. D-90 3849 Tenth Ave., New York 34, N. Y.

Please send me the units checked. I agree to pay down payment within 10 days and to pay the monthly balance as shown. It is understood there will be no finance, interest or any other charges, provided I send my monthly payments when due. It is further understood that should I fail to make payment when due, the full unpaid balance shall become immediately due and payable.

Model 670-A Total Price **\$28.40**
\$7.40 within 10 days. Balance \$3.50
monthly for 3 months.

Model TV-11 Total Price **\$47.50**
\$11.50 within 10 days. Balance \$6.00
monthly for 3 months.

Model TV-40 Total Price **\$15.85**
\$3.85 within 10 days. Balance \$4.00
monthly for 3 months.

Name
Address
City Zone State

ATR SHAV-PAK NEW, LOW PRICE!



An ATR SHAV-PAK will solve this predicament!

SHAVE IN THE COMFORT OF YOUR CAR, Boat or Plane!



Plugs into Cigarette Lighter Receptacle on Dash

\$ **9.95** LIST PRICE

Specially Designed for Operating Standard A.C. Electric Shavers in Automobiles, Buses, Trucks, Boats, and Planes.

TYPE	INPUT D.C. VOLTS	A.C. OUTPUT 60 CYCLES	OUTPUT WATTAGE	LIST PRICE
6-SPB	6	115 volts	15	9.95
12-SPB	12	115	15	9.95

Introducing ATR MIGHTY MIDGET portable INVERTER

WITH GREATER OUTPUT

Dictate reports accurately—promptly!

make your car, boat or plane a "rolling office"

with ATR INVERTERS



Plugs into Cigarette Lighter Receptacle on Dash

\$ **19.95** AND UP LIST PRICE



ATR INVERTERS . . .

especially designed for operating standard 110 volt A. C. . . .

- Dictating Machines • Tape Recorder
- Electric Razors • Wire Recorders

TYPE	INPUT D.C. VOLTS	A.C. OUTPUT 60 CYCLES	OUTPUT WATTAGE	LIST PRICE
6-DME	6	115 volts	30-40	19.95
6H-DME	6	115 volts	60-75	29.95

Above Inverters also available for 12-volt operation.

See your jobber or write factory today for complete information

ATR AMERICAN TELEVISION & RADIO CO.
Quality Products Since 1937
SAINT PAUL 1, MINNESOTA—U. S. A.

Capacity Checker (Continued from page 59)

tions, and can be disregarded for most measurements.

4. Check all doubtful capacitors for leakage before measurement to prevent erroneous readings. The ohmmeter on the 10 megohm scale will give a suitable indication of excessive leakage.

Construction of the conversion chart is not difficult. A convenient size graph can be made to accommodate three or four scales when one axis incorporates three logarithmic scales. Fig. 3 illustrates how one graph was used in plotting all curves for the Heathkit v.t.v.m. modification. The vertical axis was divided into two scales: 1 to 30 $\mu\text{fd.}$ typed in red, and 10 to 10,000 $\mu\text{fd.}$ typed in black. The use of two ranges provides sufficient spread in reading low values of capacitance. The horizontal axis was divided into convenient scales corresponding to the four a.c. voltage scales of the v.t.v.m., namely, 0 to 3 v.a.c., 0 to 10 v.a.c., 0 to 30 v.a.c., and 0 to 100 v.a.c. The 0 to 3 v.a.c. curve was drawn in red to correspond to the 1 to 30 $\mu\text{fd.}$ values on the vertical axis, also in red. With other v.t.v.m.'s it may be more convenient to use other arrangements.

After the selection of proper scales, plotting the voltage values of sample capacitors follows. At this point, the degree of precision desired by the constructor should be determined. Naturally, a large number of 1/2% or 1% micas used in the calibration of the curves would result in a chart having 1% accuracy or better, which is highly desirable, however, the cost of investment in these micas would be prohibitive. An alternate method, far less costly, was used in the construction of the chart shown in Fig. 3. Approximately 75 or 80 capacitors of various values were first checked for leakage and then plotted against their stamped values. Many of these were 5% and 10% micas. All points were then interconnected with straight lines for each range of a.c. voltage. A smooth curve was then drawn with the aid of a French curve, averaging out these straight lines. A few 1% micas were then used in series and parallel combinations to check the curves. The resulting error of calibration was found to be surprisingly small, so small in fact, it was disregarded. The completed chart can then be transferred onto a clean sheet of graph paper by means of carbon paper, inking in the curves in their respective colors for clarity.

The measurement of unknown capacitances can now be accomplished speedily and with ease. The same precautions followed when calibrating the instrument should be observed when making all measurements. Air capacitors, shielded instrument leads, trimmers and the like will often pick up stray voltages when being measured. Erroneous readings can be mini-

mized by first clipping only the a.c. input lead to the component to be tested, and noting the stray voltage reading. Subtract this reading from the final voltage reading before entering the value into the chart.

Confidence in the use of this method of measuring capacities can be gained by constant usage. Its versatility has been constantly extended; for example, trimmers can be preset to any desired capacity, instrument cables cut to a predetermined capacity value, and unknown interelectrode tube capacities measured.

It has been found that a frequent check on the calibration with the use of several 1% micas resulted in no detectable change in $\mu\text{fd.}$ values as long as the precautions discussed in the section on calibration were observed. —30—

NEW FINGER PIECES

By ARTHUR TRAUFFER

AMONG the many thousands of "Vibroplex" semi-automatic transmitting keys ("bugs") in use by "hams" and telegraph operators throughout the world, there is occasionally a need for replacing broken, worn, or chipped, red plastic finger pieces.

To save the time and expense of sending away for a new thumb-piece and finger-piece, the writer made a trip to the local dime store and invested 20¢ for a red plastic pan-lid-knob, and a red plastic windshield scraper. Both items were exactly the same shade of red and made a matched pair of finger pieces! The oval-shaped thumb-piece was jigsawed from the windshield scraper, the rough edges sanded smooth, and the two holes drilled, and one of the holes threaded, the same as the original piece.

The 8-32 screw in the red pan-lid-knob fits the threaded hole in the lever of the bug. The shank of the knob was sawed off to the same length as the original knob, and the screw was twisted into the knob securely and sawed off to the same length as the screw in the original knob.

Incidentally, the 8-32 screws in these plastic pan-lid-knobs also fit the levers of standard (vertical motion) radio transmitting keys, so you can also use these knobs as replacements for standard keys. —30—

Inexpensive knobs and a plastic windshield wiper can be used to make replacements for the finger pieces on your "bug." See text.

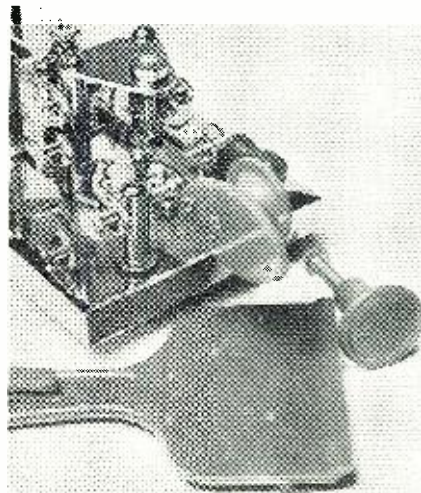

GREATEST TUBE BUYS

Every Tube **GUARANTEED** a **FULL YEAR**
JOBBER! **DISTRIBUTORS!** We Have A Wonderful Deal For You

WRITE!
WIRE!
PHONE!

Our Tubes are of Excellent Quality Because--

1. We've specialized in selling vacuum tubes exclusively for many years.
 2. All tubes offered herein are obtained from Receiver Manufacturers' surplus, various gov't agencies and other surplus sources. Most of these tubes are brand new and the balance is removed from gov't and other equipment. **WE UNCONDITIONALLY GUARANTEE EVERY TUBE YOU BUY.**
 3. Our modern, completely equipped laboratories check every tube received. You are invited to see this special equipment in operation.
- Even though our inventories include almost every tube type made over the past 20 years - in quantities of more than a million assorted types - it is impossible to list every type. You are, therefore, urged to include any additional type required in your order.

0A287
 0A3/VR75 .97
 0A4G . . .60
 0B2 . . .74
 0B3/
 VR90 .90
 0C3/
 VR105.95
 0D3/
 VR150.85
 0Z4 . . .59
 1A4P . . .35
 1A5GT . .40
 1A7GT . .45
 1AB5 . .38
 1B3GT . .67
 1C5GT . .40
 1C7G . .37
 1D7GT . .75
 1E7GT . .35
 1F4 . . .40
 1F5G . .44
 1H4G . .40
 1H5GT . .38
 1J6G . .59
 1L4 . . .45
 1L6 . . .61
 1LA4 . .59
 1LA8 . .75
 1LB4 . .77
 1LC5 . .59
 1LC6 . .75
 1LD5 . .49
 1LE3 . .75
 1LG5 . .75
 1LM4 . .75
 1LN5 . .55
 1NSGT . .61
 1PSGT . .56
 1Q5GT . .55
 1R4 . . .81
 1R5 . . .47
 1S4 . . .55

1S5 . . .40
 1SA6 . .48
 1T4 . . .46
 1U4 . . .46
 1U5 . . .40
 1X2 . . .55
 2A3 . . .90
 2A5 . . .49
 2A6 . . .49
 2A7 . . .60
 2B7 . . .62
 2X2 . . .39
 2X2A . .14
 3A4 . . .44
 3A5 . . .90
 3A8GT . .59
 3B7 . . .39
 3D6 . . .38
 3LF4 . .71
 3Q4 . . .48
 3Q5GT . .48
 3S4 . . .46
 3V4 . . .50
 5T4 . . .25
 5U4G . .49
 5V4G . .76
 5Y3G . .38
 5Z3 . . .33
 6A6 . . .45
 6A7 . . .80
 6A8 . . .65
 6AB4 . .42
 6AB7 . .71
 6AC5GT .95
 6AC7 . .68
 6AF5 . .89
 6AF6G . .75
 6AG5 . .47
 6AG7 . .90
 6AH6 . .98
 6AK5 . .59
 6AL5 . .35
 6AQ5 . .39
 6AQ6 . .36

6AQ7GT . .68
 6AS5 . .62
 6AT6 . .36
 6AU6 . .40
 6AV5GT .79
 6AV6 . .36
 6AX4GT .57
 6B7 . . .93
 6B8G . .64
 6BA6 . .38
 6BA7 . .55
 6BC5 . .49
 6BE6 . .37
 6BF5 . .69
 6BG6G .1.15
 6BH6 . .45
 6BJ6 . .41
 6BK7 . .89
 6BL7GT .65
 6BN6 . .79
 6BQ6GT .75
 6BQ7 . .88
 6C4 . . .35
 6C5 . . .39
 6C6 . . .54
 6C8G . .85
 6CB6 . .42
 6CD6G .1.05
 6D6 . . .67
 6D8G . .95
 6E5 . . .76
 6F6 . . .45
 6F7 . . .90
 6F8G . .69

6G6G . .63
 6H6 . . .49
 6J5 . . .38
 6J6 . . .50
 6J7 . . .49
 6J8G . .90
 6K6GT . .39
 6K7G . .38
 6K8G . .64
 6L6G . .99
 6L6GA .99
 6N7 . . .95
 6Q7 . . .49
 6R7 . . .49
 6S4 . . .39
 6S7G . .55
 6SA7 . .40
 6SC7 . .75
 6SD7GT .38
 6SF5GT .45
 6SF7 . .58
 6SG7 . .40
 6SH7 . .60
 6SH7GT .50
 6SJ7 . .54
 6SK7 . .39
 6SL7GT .49
 6SN7GT .48
 6SQ7 . .49
 6SR7 . .45
 6ST7 . .48
 6T8 . . .57
 6U7G . .45
 6U8 . . .59

6V6 . . .38
 6W4GT .41
 6W6GT .41
 6X4 . . .35
 6X5 . . .35
 6X8 . . .70
 7A4 . . .45
 7A5 . . .55
 7A6 . . .65
 7A7 . . .65
 7AD7 . .90
 7AG7 . .55
 7AH7 . .55
 7B4 . . .44
 7B5 . . .55
 7B6 . . .55
 7C4 . . .55
 7C7 . . .65
 7E5 . . .59
 7E6 . . .40
 7F7 . . .64
 7F8 . . .90
 7G7 . . .80
 7H7 . . .56
 7J7 . . .75
 7K7 . . .80
 7L7 . . .77
 7N7 . . .57
 7Q7 . . .57
 7R7 . . .59
 7S7 . . .83
 7V7 . . .87
 7W7 . . .85
 7X6 . . .57

7Y4 . . .40
 7Z4 . . .45
 12A6 . .49
 12A7 . .98
 12AH7GT .85
 12AL5 . .40
 12AT6 . .35
 12AT7 . .62
 12AU6 . .36
 12AU7 . .59
 12AV6 . .44
 12AV7 . .64
 12AX4GT .55
 12AX7 . .55
 12AY7 . .72
 12BA6 . .47
 12BA7 . .59
 12BD6 . .46
 12BE6 . .45
 12BH7 . .60
 12C8 . .34
 12F5GT .35
 12H6 . .45
 12J5GT .39
 12J7GT .57
 12K7 . .53
 12K8 . .55
 12Q7G . .57
 12S8GT .60
 12SA7GT .62
 12SC7 . .68
 12SF5 . .48
 12SF7GT .68
 12SC7 . .70

12SH7 . .70
 12SJ7 . .55
 12SK7GT .49
 12SL7GT .49
 12SN7GT .50
 12SQ7GT .53
 12SR7 . .49
 12Z3 . . .39
 14A4 . .65
 14A5 . .57
 14A7 . .53
 14AF7 . .59
 14B6 . .45
 14B8 . .63
 14C5 . .80
 14C7 . .65
 14E6 . .65
 14E7 . .80
 14F7 . .65
 14F8 . .90
 14H7 . .57
 14N7 . .67
 14Y4 . .67
 19 . . .45
 19BG6G .15
 19T8 . .75
 22 . . .40
 25AV4GT.80
 25BQ6GT.75
 25LG6GT .40
 25W4GT .45
 25Z5 . .60
 25Z6GT .40
 26 . . .42
 27 . . .37
 32L7GT .95
 35C5 . .37
 35L6GT .45
 35W4 . .59
 35Y4 . .44
 35Z3 . .40

35Z5GT .59
 36 . . .35
 37 . . .35
 39-44 .35
 42 . . .40
 43 . . .53
 45Z3 . .40
 46 . . .45
 47 . . .85
 49 . . .38
 50L6GT .61
 50X6 . .62
 50Y6GT .57
 56 . . .47
 57 . . .53
 58 . . .56
 70L7GT .1.00
 71A . . .52
 76 . . .42
 77 . . .53
 78 . . .43
 81 . . .1.10
 82 . . .67
 83 . . .77
 84 . . .52
 85 . . .57
 89Y . . .29
 117L7GT1.17
 117Z3 . .38
 117Z4GT .73
 117Z6GT .70
 2051 . . .93
 803 . . .2.95
 807 . . .1.25
 814 . . .3.50
 832A . .7.95
 866A . .1.45
 Minimum Order: \$10.00.
 Terms: 25% with order,
 balance C.O.D. Please
 include postage. All prices
 subject to change
 without notice.

TRANSAMERICA ELECTRONICS CORP.
115 Liberty Street New York 6, N. Y.

McGEE OFFERS \$100,000 STOCK OF CUSTOM RADIO CHASSIS

NEVER BEFORE AT SUCH LOW PRICES! EVEN SAVE ON COAXIAL SPEAKERS AND RECORD CHANGERS

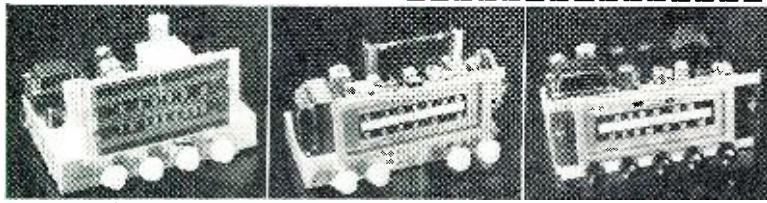

(A) HALLCRAFTERS S-78A (B) JACKSON FA8C (C) JACKSON AM9A

PICK YOUR CHASSIS FROM THESE THREE EACH ONE AN OUTSTANDING McGEE VALUE!

9-TUBE HI-FIDELITY \$39.95

RECEIVES BROADCAST 550 TO 1650 K.C.

12 Watts Audio • Separate Tone Controls

(C) Jackson Model AM9A, • watt high fidelity audio amplifier and broadcast tuner combined, at less than you would normally pay for the amplifier alone. Push-pull 6V6 output tube. Frequency response from 30 to 15,000 cps. Inputs for crystal or G.E. variable reluctance pickup and crystal or dynamic microphone. Separate bass boost and treble matches 3.2 or 8 ohm speaker. Heavy duty 150 ml power transformer. Illuminated slide rule dial with etched glass scale, 3 gang condenser with tuned R.F. stage and loop antenna. Receives broadcast 550 to 1650 kc. Size 13" long, 6" high and 9 1/2" deep. Complete with tubes: 2-6BA6, 6AU6, 6BE6, 6SN7, 6AT6, 2-6V6 and 5Y3. Knobs, escutcheon, diagram and instructions included.

Model AM9A, Hi-Fi amplifier and tuner. Ship. wt. 19 lbs. Sale price, \$39.95

Model AM9A with our P15-CR 12" coaxial PM speaker, both for \$49.95

Model AM9A with our P15-CR 15" coaxial PM speaker, both for \$59.95.

11-TUBE FM-AM HALLCRAFTERS

Regular \$89.50

\$69.95

McGEE'S SALE PRICE LESS SPEAKER

★ HIGH FIDELITY ★ AUTOMATIC FREQUENCY CONTROL

(A) Hallcrafters Model S-78A, 11 tube FM-AM superb custom chassis. Size 7 3/4" x 12 1/2" x 11" deep. Complete with tubes, knobs, escutcheon, diagram and instructions. Receives broadcast 540 to 1700 kc, plus FM 88 to 139 mc. AFC holds FM stations in perfect tune. Output transformer matches 3.2 ohm or 500 ohm. High fidelity response 50 to 14,000 cps. Bass boost tone control. A full 11 tube transformer powered chassis with push-pull 6X6 audio. This chassis found in S400 to S600 radio combinations. Has input for crystal phono pickup. Self-powered preamplifier necessary for G.E. variable reluctance cartridge, \$3.95 extra.

- S-78A Hallcrafters 11 tube FM-AM chassis. Ship. wt. 22 lbs. \$69.95
- S-78A Hallcrafters with our CU-14Y 12" coaxial PM speaker. \$79.95
- S-78A Hallcrafters with our P15-CR 15" coaxial PM speaker. \$89.95
- 3/532 Collaro 3 speed record changer, less cartridge, \$38.95 extra.
- 3/532 Collaro changer with G.E. RPX-052 Golden Treasure cartridge, \$58.95 extra.
- 45 RPM spindle for Collaro changer, \$2.50 extra.

8-TUBE JACKSON FM-AM \$39.95

REGULAR \$59.95 VALUE- ONLY 1000 TO SELL

(B) Model FA8C, Jackson 8 tube FM-AM custom chassis. Receives broadcast 540 to 1600 kc, and FM 88 to 108 mc. 9" etched glass slide rule dial. Chassis size 7" x 13" x 7" high. Full superb circuit with AVC. Complete with tubes; 12A7T, 6BE6, 2-6BA6, 6A1S, 6AT6, 6AQ5 and 6X4. Output transformer matches 3.2 or 8 ohm speaker. Input for crystal pickup with radio-phono switch on front of chassis. Full size "High-Q" ferrit loop stick antenna mounted on chassis. Separate antenna for FM. Has bass boost tone control. Knobs, escutcheon, diagram and instructions included.

Model FA8C, 8 tube FM-AM radio chassis. Ship. wt. 12 lbs. Sale price \$39.95.

Model FA8C with our CU-14Y 12" coaxial PM speaker, both for \$49.95.

Model FA8C with our P15-CR 15" coaxial PM speaker, both for \$59.95.



McGee's Famous
12 AND 15 INCH COAXIAL P.M.
HIGH FIDELITY SPEAKERS

\$12.95 **\$23.95**

12-Inch Model CU-14Y 15-Inch Model P15-CR

Model CU-14Y, 12" high fidelity coaxial PM speaker. Response from 30 to 17,500 cps. Full 6.8 oz. Alnico V magnet in the 12" woofer. Special coaxially suspended high frequency tweeter. Built-in crossover network. Only two wires to connect to your radio or amplifier. Matches 3.2 to 8 ohm output. Don't confuse this speaker with many cheap speakers that are offered. This is a fine quality speaker. Stock No. CU-14Y. Sale price \$12.95 each, two for \$25.00.

Model P15-CR, 15" high fidelity coaxial PM speaker. Response down to 20 cps. and up to 17,500 cps. Full 2 1/2 oz. Alnico V magnet in the 15" woofer. Specially made, coaxially suspended 5" high frequency tweeter. Built-in crossover network. Only two wires to connect. Matches 3.2 to 8 ohm output transformer. A regular \$62.50 list speaker. Model P15-CR, McGee's Sale price, \$23.95.

\$65.00 LIST COLLARO CHANGER

3-SPEED HI-FI, MODEL 3/532 IMPORTED FROM ENGLAND

\$38.95

McGEE'S SALE PRICE

Regular \$65.00 list. Collaro Model 3/532, 3 speed automatic record changer that intermixes 10" and 12" records of the same speed. On sale at McGee for only \$38.95. Famous imported English changer popular among audio enthusiasts all over America. Has heavy motor and weighted turntable with rubber pallet. Shuts off automatically after last record. Compensating spring shifts weight of tone arm for LP and standard records. Plug-in head can be fitted with your favorite cartridge. Each changer shipped with service sheet and instructions. Changer size 14 1/2" long, 12 1/4" wide, 4 3/4" above motor board and 6 8/16" below. Model 3/532 Collaro changer available in 4 colors: green, grey, cream and brown hammettone. Specify color desired. Ship. with G.E. RPX-052 Golden Treasure cartridge, only \$58.95.



ENGLISH GARRARD CHANGERS

RC-80 WITH GE RPX-052 \$68.51 RC-90 WITH GE RPX-052 \$88.11

Garrard "Triumph" Model RC-80, 3 speed automatic record changer. Plays all 3 sizes automatically and shuts off after last record. Heavy duty AC phono motor and weighted turntable gives constant speed. Muting switch turntable pickup during change cycle. Complete with two separate plug-in shells for either crystal or G.E. variable reluctance cartridge. Overall size 13 1/4" wide, 15 1/2" deep and 8" high. 2 1/2" below motor board and 5 1/2" above. 105-125 volt, 60 cycle AC. Ship. wt. 20 lbs. Price, \$38.95. Large 45 RPM spindle \$3.43 extra. Model RC-80 Garrard changer, less cartridge \$48.51. With flip-over crystal cartridge \$52.43. With RPX-052 G.E. Golden Treasure cartridge \$68.51.

Garrard "Crown" Model RC-90, new 3 speed automatic record changer. All of the features of the RC-80, plus many new developments. Has new adjustable speed control to regulate speed faster or slower on all 3 speed settings. Manual provision for playing single records. New 4 pole heavy duty AC motor and heavy turntable eliminates wow. Complete with two separate plug-in shells for desired cartridge. Finished in cream and brown. 15 1/2" long, 13 1/2" wide, 5 1/2" above motor board and 3 7/8" below. Ship. wt. 19 lbs. Large 45 RPM spindle \$3.43 extra. Model RC-90 Garrard changer, less cartridge \$68.11. With flip-over crystal cartridge \$72.06. With G.E. Golden Treasure variable reluctance cartridge \$88.11.

21" MAHOGANY TELEVISION-PHONO CABINET



RT-21MA \$49.95

Mahogany Television-Phono combination cabinet with half doors, for 20" and 21" TV chassis and record changer. 36 1/2" high, 39 3/4" w. and 22" deep. Baffle cut for 12" speaker. TV compartment 21 1/2" high, 21 1/4" wide and 19" deep will hold most 20" and 21" chassis. Changer shelf 15" x 16" with 9" height clearance. Ship. wt. 75 lbs. Sale price, only \$49.95. 21" gold trim plastic safety shield and mask to fit cabinet, \$6.95 extra. No. A13-9, ball bearing changer drawer slides, \$1.39 pr., extra.

DRT-21M \$59.95

Deluxe flamed grain mahogany Television-Phono combination cabinet for 20" and 21" TV chassis and record changer. Beautiful full door style with matching front panels and piano finish. 37" high, 40 1/2" wide and 22 3/4" deep. Baffle cut for 12" speaker. TV compartment 21 1/2" high, 23 1/2" wide and 19" deep. Will hold most 20" and 21" TV chassis. Changer shelf 15" x 17" with 9" height clearance. Ship. wt. 90 lbs. Stock No. DRT-21M. Sale price only \$59.95. 21" mask and safety glass available at \$6.95 extra. (Requires fitting to cabinet) No. A13-9, ball bearing changer drawer slides, \$1.39 pr.

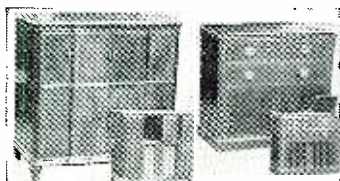

WALNUT RADIO-PHONO-CABINET

Made for \$800.00 Class Capehart

Cost Over \$200.00 to Build

\$79.95

No. K-275 (left illustration). Walnut radio-phono cabinet 42" h. 42" w. 22" deep. Made for Capehart selling for \$800. Radio chassis area 14" h. 11 1/2" w. Changer compartment 14" h. 26" w. 12" deep. Baffle completely enclosed. Cabinet weighs approx. 175 lbs. Ship. wt. 275 lbs. Sale price \$79.95.

WALNUT RADIO-PHONO-CABINET

Made for \$700.00 Class Capeharts

Cost Over \$200.00 to Build

\$59.95

B-175B (right illustration). Walnut radio-phono cabinet 37" h. 40" w. 21" deep. Radio area 14 1/2" wide. Changer compartment 25 1/2" wide. Hinged top lifts in two sections. Baffle for 12" speakers. Made for \$700 Capehart combination. Ship. wt. 160 lbs. Sale price \$59.95.

SALE!

RADIO PHONO COMBO CABINETS

For \$800.00 Class Sets

(Pictured to the Left)

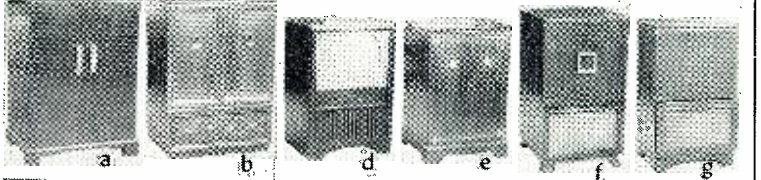

TELEVISION CONSOLE CABINETS AT LESS THAN FACTORY COST!

FOR YOUR TV CHASSIS—MODELS FOR 27 INCH TO 16 INCH CHASSIS

- 27" Mahogany Full Door Cab. \$69.95
- (a) No. 27-10A, Mahogany with full doors for 27" TV. 21" deep. Chassis area 27 3/4" w. 25" h. 18 1/4" deep. Baffle cut for 10" speaker. A beautiful cabinet that cost the factory over \$100. Made for a \$600 TV set. Ship. wt. 90 lbs. Sale price \$69.95. Blank panel \$5.00 extra.
- 27" 3/4 Door Mahogany Cab. \$69.95
- (b) No. 27-34MA, Mahogany with 3/4 doors for 27" TV. 21" deep. Chassis area 27 3/4" w. 25" h. 18 1/4" deep. Baffle cut for 10" speaker. Made for one of America's largest TV builders. Cost over \$100. Ship. wt. 90 lbs. Sale price \$69.95. Blank panel \$5.00 extra.
- 21" Mahogany Cab. \$29.95
- (c) No. 21-DFM, 21" Mahogany open front. 21" deep. Baffle cut for 2 10" speakers. Made for one of America's largest TV builders. Cost over \$100. Ship. wt. 90 lbs. Sale price \$29.95.
- 17" Mahogany Full Door Cab. \$29.95
- (e) No. AH-430, Mahogany with full doors, 36" h. 24" w. 21 3/4" deep. Chassis area 22" w. 17 3/4" h. 18 3/4" deep. Blank panel. Holds 17" TV easily. Baffle for 10" speaker. Ship. wt. 80 lbs. On sale at less than it cost a famous TV factory. Sale price \$34.95.
- 17" Walnut 1/2 Door Cabinet. \$29.95
- (f) No. AH-85A, Walnut with half doors, 36" h. 20 3/4" w. 21 1/2" deep. Chassis area 19" w. 18 3/4" h. 18 3/4" deep. Baffle eliminates wow. Most 17" sets. Baffle cut for 10" speaker. Ship. wt. 65 lbs. An attractive well proportioned cabinet on sale at only \$26.95.
- 17" TV Cab. with Phono Drawer. \$19.95
- (g) No. SE-21, TV-phono comb. 40" h. 24" w. 18 1/2" deep. Blank panel. TV chassis area 19" h. 20 1/2" w. Changer drawer 19 3/4" w. 13" deep. Baffle for 10" speaker. Mahogany finish. Ship. wt. 75 lbs. Sale price \$19.95.

WEBCOR 3 SPEED CHANGER \$29.95

WITH RPX-050 G. E. CARTRIDGE

114-43, Webcor 3 speed automatic record changer with G.E. RPX-050 variable reluctance cartridge. Plays all 3 speeds and all 3 sizes. Shuts off after last record. Has neutral position to prevent damaging drive wheels. Size, 13 1/2" x 12". Ship. wt. 12 lbs. Sale price, \$29.95.



McGEE RADIO COMPANY

OUR NEW ADDRESS IS
F.O.B. KANSAS CITY
SEND 25¢ OR FULL
REMITTANCE WITH ORDER.
BAL. SENT C.O.D.
1901 McGEE St., KANSAS CITY, MISSOURI

McGEE'S JANUARY BARGAIN SALE! TERRIFIC VALUES



MINIATURE BROADCASTING STATION FOR THE HOME
 New 1955 Model \$7.95
 Crystal Mike \$4.95 Extra



Sensational new 1955 model miniature broadcasting station for microphone and phonograph. Can be received on any broadcast radio in the home. No wires to connect; tunes in just like a radio station. Has input jacks for crystal mike or record player. Complete with 12K8 and 70L7 tubes and instructions. Operates on 110 volts AC. Simple to operate; one control fades from microphone to record. Frequency can be adjusted so as not to interfere with local radio stations. Stock No. LE-3, miniature broadcasting station. Ship. wt. 3 lbs. Net price \$7.95. Crystal mike and desk stand, \$4.95 extra.



6" SESSIONS CLOCK-TIMER
 With Plastic Cabinet \$3.95

6" Sessions Clock-Timer in plastic case 7" x 9 3/8" tall, 3" deep. Was intended for a kitchen clock radio. Lower part of case was used for a small radio chassis. Lower portion has a usable space of 6 3/4" x 4" high and 2 3/8" deep with 3" diameter hole in front. Many ways this attractive clock and cabinet could be used, such as mounting a small bell below the clock for use as a kitchen clock and timer. Clock has sweep second hand and 15 amp. 125 volt switch to turn on appliances at any pre-set time. Case available in Ivory, Green or color choice. Sale price only \$3.95.



RC-600 REGENCY UHF CONVERTER \$16.95

UHF converter SCOP! Brand new RC-600, Regency UHF converters. Special sale price only \$16.95. Regular dealers net was \$37.46. All channel UHF, 14 thru 83. Only 100 to sell. Model RC-600. Ship. wt. 6 lbs. Special sale price only \$16.95.



50-WATT BOOSTER AMPLIFIER

50-WATT BOOSTER AMP. \$39.95

2-Mike Pre-Amp \$12.95 Extra. Not a Kit, but a Manufactured Amp.

A sensational value. A 50 watt booster amplifier with push-pull, parallel 616 output transformer or use with the PR-2X pre-amplifier. The amplifier has one input jack with 1 volt input giving 50 watts of audio. Amplifier has a 6 lb. potted case high fidelity output transformer with taps at 4-8-16-60 and 250 ohms. 225 mill power transformer and 5U4C rectifier. Includes tone and bass boost tone control. Chassis size, 8" x 6 1/2" x 1 1/2". Model No. PA-55N. Ship. wt. 26 lbs. Sales price, \$39.95. PR-2X, 2 mike input pre-amplifier plug is directly to the PA-55N 50 watt booster amplifier. Allows use of 2 microphones, either crystal dynamic and one low level input. Furnished with 4 ft. connecting cable and plug for remote control of the 50 watt booster. Chassis size, 5 3/4" x 3 1/2" x 2 1/2". Model PR-2X. Sale price, \$12.95.

25 WATT—HIGH FIDELITY DYNAMIC SPEAKER SYSTEM \$2495



Sale Price \$2495
 2-12" WOOFERS
 2-5" TWEETERS
 POWER SUPPLY AND L-C CROSS-OVER NETWORK

25 watt, High-Fidelity Dynamic Speaker System, complete with 2000 cycle genuine inductance-capacitance cross-over network, two 12" woofer speakers, two 5" high frequency tweeter speakers and separate 110 volt AC power supply. Frequency response with fields excited to saturation by the power supply. The tweeters are specially made with cones designed to respond only to the high frequency of the audio spectrum. The 2000 cycle cross-over network is of the high quality inductance-capacitance type which prevents frequencies below 2000 cycles from entering the tweeters and drives has built-in variable attenuator to adjust volume to the correct level. This 4 speaker system is simple to connect to any 4 or 8 ohm output of your high fidelity audio amplifier or radio. No. SP-12125CR, High Fidelity Dynamic speaker system. Ship. wt. 15 lbs. Net \$24.95. No. SP-12125, High Fidelity Dynamic speaker system, as described above, but less the 2000 cycle cross-over network and with separate attenuator control. Net \$14.95.

3-STATION INTERCOM MASTER \$1695

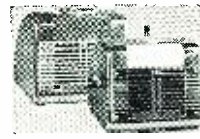

Powerful 3 station intercom master housed in a chrome plated metal cabinet 7 1/2" x 6" x 5". Full 3 tube amplified for AC-DC operation. Press-to-talk switch is on top of cabinet. Volume control, off-on switch and station selector are located on either side. Two intercom stations and three sub-stations. Master is quiet except when talk-listen switch is pressed, or when call-back switch is pressed at the sub. Ship. wt. 10 lbs. Model IPM-A3, station master, \$16.95. Alnico V PM speaker and call-back switch. \$3.95 each or 3 for \$10.00. Requires 3 wire intercom cable, \$1.95 per 100 ft. 500 ft. for \$8.95.



10 WATT PORTABLE P.A. SYSTEM

10" PM SPEAKER CRYSTAL MIKE \$34.95

PA-12, 5 tube 10 watt portable P.A. system. Push-pull, 75'S. U.L. approved amplifier with good frequency response. Inputs for crystal microphone and phono. Separate volume controls and variable tone control. Heavy 10" Alnico V PM speaker. Amplifier fits in bottom of case. Case size, 21" x 16" x 13". Snap on removable back. Complete with tubes, crystal mike on non-removable desk stand and connecting cables. Stock No. PA-12. Ship. wt. 40 lbs. Sale price only \$34.95.

6-TUBE 2 BAND RADIO KIT \$1495



6 tube, 2 band AC-DC radio kit, complete with speaker and plastic cabinet. Popular with schools and colleges for training in radio. Requires matching sub-station, Model PM-A5, complete with 5" Alnico V PM speaker and call-back switch. \$16.95 each and 3 for \$10.00. Requires 3 wire intercom cable, \$1.95 per 100 ft. 500 ft. for \$8.95.

RADIO-TV SERVICEMEN CLASSIFIED BARGAIN LISTINGS. SPECIAL PRICES, MOSTLY BELOW REPLACEMENT COST. SOME AT A FRACTION OF THEIR PRODUCTION COST. BARGAIN LISTINGS!

FAMOUS STANDARD COIL CASCODE TV TUNERS
 \$12.95 EACH
 2 FOR \$25.00

TV-2000 series Standard Coil cascode tuners complete with 6J6 and 6BK7 or 6BQ7 tubes. Thousands of TV sets use this famous tuner. Tuner 12 channels (2 thru 13). For 21 mc I.F. circuit. This tuner will give 2 to 1 better reception than the old pentode type. Many servicemen replace all older tuners with this cascode model. Available with either 27" or 41 1/2" shaft length. A tremendous purchase makes our low \$12.95 price possible. Specify shaft length desired. Stock No. TV-2000-3. Sale price \$12.95 each. 2 for \$25.00.

NEW RCA TUNER \$7.95
 Brand new famous 201E1 RCA 13 channel tuner complete with 3-6J6 tubes. Completely wired, ready to install. Stock No. RCA-13P tuner complete with 3-6J6 tubes. Sale price only \$7.95.

TWO-TUBE SARKES-TARZIAN TV TUNER \$8.95 WITH TUBES
 Two-tube Sarkes-Tarzian TV tuners. 12 channel, 2 thru 13, for many popular makes of TV sets. 21 to 25 mc output. A good replacement for private label sets, with one tube tuner; also general replacement use. Priced complete with 6J6 and 6BQ5 tubes. Shaft length approx. 4". Model No. TT-3A. Sale price, \$8.95 each.

24"-27" MAHOAGANY TV CABINET \$39.95
 Large mahogany open face cabinet for 27" or 24" television chassis. 44" high, 30 1/4" wide and 24 1/2" deep. Will hold a TV speaker. This cabinet and other TV cabinets listed might also be used as a high fidelity speaker baffle.

Stock No. KL-27X. Ship. wt. 90 lb. Sale price \$39.95. Blank front panel available at \$5.00 extra.

STANDARD COIL TV BOOSTER \$7.95

Model B-51, Standard Coil TV booster only \$7.95. Brand new in factory cartons. Utilizes printed circuit high frequency circuits for channel selection. Has 6AK5 tube. Modern design dark brown plastic cabinet 8" x 4 1/4" x 4 1/2". For 110 volt 60 cycle AC operation. Ship. wt. 5 lb. Sale price \$7.95, 2 for \$15.00.

78 RPM phono motors with turntable, for 110 volt, 60 cycle operation. Stock No. NR-1. Sale price \$1.29 each. \$5.00 for 5 for only \$25.00.

Portable cases intended for tape recorders of various types. Stock No. NR-2, \$6.99. \$2.99 each. 3 assorted for \$8.99.

General Electric Model #1201, 12", 14.5 channel selection. Has 6AK5 tube. Modern design dark brown plastic cabinet 8" x 4 1/4" x 4 1/2". For 110 volt 60 cycle AC operation. Ship. wt. 5 lb. Sale price \$7.95, 2 for \$15.00.

12" RCA PM speaker with 3.2 oz. magnet. Stock No. NR-4. \$3.95 each \$10.50 for 3 for

12" Television speaker. Field coil type with 90 to 100 ohm field. Stock No. NR-5 \$1.49

6 x 9", 1000 ohm field speaker. 99c

8", 750 ohm field speaker with 6V6 output transformer. Stock No. NR-7 99c

Kit of 50 assorted TV knobs. Stock No. NR-10 \$1.99

Kit of 50 assorted Radio knobs. Stock No. NR-11 \$0.79c

Kit of 50 assorted set screw type radio knobs. Stock No. NR-12 \$1.49

Kit of 1 pound radio and TV hardware, nuts and bolts. Stock No. NR-13 \$0.99c

Kit of 10 assorted TV focus coils. Some magnet types. Stock No. NR-14 \$4.95

Kit of 25 Television filter condensers. Aluminum can EP type. Late production. Stock No. NR-15 \$4.95

Kit of 25 Micamold tubular electrolytics for television, radio and amplifier use. Stock No. NR-16 \$4.95

Kit of 50, 1 watt, latest type insulated resistors. Good sizes. Stock No. NR-17 \$1.49

Kit of 25 Micamold 150 volt tubular filter banks for AC-DC radios. All multiple section banks. All good sizes. Stock No. NR-18 \$4.95

Kit of 100 assorted 400 and 600 volt plastic tubular bypass condensers. \$4.95

.001 to 1 mfd. Stock No. NR-19 \$4.95

Kit of 10, 1/2 to 1 megohm volume controls. All with shafts at least 1 1/2" long and with on-off switch. Stock No. NR-20 \$2.99

Kit of 25 TV voltage dividers. 20 to 50 watt. Stock No. NR-21 \$1.49

Kit of 10, 456 kc I.F. coils. Regular and midge sizes. No. NR-22 \$1.99

Kit of 25 assorted radio and TV small tube sockets. All latest types. Stock No. NR-23 \$0.49c

Kit of 10 single TV controls. Part wire wound. Stock No. NR-24 \$1.99

Kit of 100 assorted 1/2 watt insulated resistors. All good sizes and all coded. Latest production. Stock No. NR-25 \$1.99

Deal of 5 television flybacks (Horizontal output transformers) all for only \$7.95. Includes 1 Philco flyback, 2 of our 7713 G.E. built flybacks, 1 No. 76381 RCA flyback, as used on Model 7711B chassis K5C47GF-2 and 1 No. PC10120 flyback used by RCA, Capetart, Emerson and others.

Use only one of these flybacks for TV service and you have your investment back. Ship. wt. 6 lbs. Stock No. MCGX-5 \$7.95

Deal of 5 popular deflection yokes for TV service, only \$7.95. Remember, your cost on yokes is \$6.00 or more regular net. Now you can get these top quality yokes for only \$7.95 each and plenty on hand. You get 4-70 degree cosine yokes and 1-52 degree yoke. A lucky purchase makes this value possible. Stock No. WA-52 deal of 5 deflection yokes for only \$7.95

Assortment of 10 width and linearity coils for only \$1.49. Here is an assortment that every TV service shop should have. We find that it is not hard to tell by the DC resistance and general appearance of the coil that you need. Buy this assortment of 10 width and linearity coils and save time and money. Stock No. BB-10 \$1.49

10 width and linearity coils for only \$1.49

INDIVIDUALLY CARTONED ELECTRONIC RADIO & TV TUBES

McGee offers you a wide selection of good quality TV and Radio tube types. Individually cartoned. Our private brand. These are not set mfg's. culls, but a carefully inspected private line of tubes with a full 6 months' guarantee. Types listed are in stock in good quantity at this time. Thousands sold. Order 30 tubes and take 10% off the listed prices.

1A7GT59	6A0549	6J679	12BH779
5Y3GT1.09	6A2949	6K6GT59	12BY779
164GT59	6AR559	6K7G59	12J7GT59
1H5GT59	6AT649	6K8T59	12AL759
4R559	6AX4GT59	6L6G1.09	12Q7GT59
1R559	6B8G39	6L6V1.09	12SFSGT69
1T5GT59	6B759	6P5GT59	12AT759
1U459	6B759	6S8GT59	12SJ7GT59
1U559	6B8G59	6S7G59	12SL7GT79
32A1.10	6BE659	6S7GT59	198GG1.79
3A459	6BE659	6S7GT59	19T889
3Q459	6BF659	6S7GT59	25B6GT89
3S459	6AV659	6S7GT59	25C6GT89
3V459	6BH659	6S7GT59	32L7GT79
5U4G69	6B759	6S7GT59	35B559
5Y3GT49	6BK749	6S7GT59	35C659
6A8A69	6BL7GT99	6S7GT59	35W454
6A769	6BQ6GT99	6S7GT59	35Z6GT55
6A769	6BZ799	6S7GT59	50B559
6A769	6C499	6S7GT59	50L759
6A769	6C659	6S7GT59	70L7GT59
6A769	6C6G1.49	6S7GT59	

McGEE RADIO COMPANY PRICES F.O.B. KANSAS CITY
 SEND 25¢, OR FULL REMITTANCE WITH ORDER. BAL. SENT C.O.D.
 OUR NEW ADDRESS IS 1901 MCGEE ST., KANSAS CITY, MISSOURI

BC-221 Frequency Meter

Real Value! QUANTITY IS LIMITED—so first come, first served. They are just like new, with original calibration charts. Range 125-20,000 KC with crystal check points in all ranges. Complete with crystal and tubes. Standard with AC power supply. **\$139.50**

MODULATED TYPE \$159.50
 MODULATED TYPE with AC Power Supply \$199.50

Limited quantity of BRAND NEW MODULATED FREQ. METERS \$210.00

These Frequency Meters are factory treated, checked for frequency alignment and GUARANTEED.

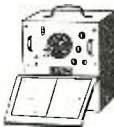

CHECK OUR NEW LOWER PRICES!

SCR-274N COMMAND and ARC-5 EQUIPMENT RECEIVERS

	USED	EXCELLENT USED	NEW
BC-453—190 to 550 KC.....	\$19.95	\$39.95	
BC-454—3 to 6 MC.....	12.95	19.95	
BC-455—6 to 9 MC.....	9.95	17.95	
1.5 to 3.....	19.95		

TRANSMITTERS

A-958—2.1 to 3 MC.....		24.95	
BC-457—4 to 5.3 MC.....		12.95	
BC-458—5.3 to 7 MC.....	\$7.95	11.95	
BC-459—7 to 9.1 MC.....		19.95	
T-15 ARC 5—500 to 800 KC.....		19.95	

ADDITIONAL EQUIPMENT

BC-456 Modulator.....		4.95	
BC-450 Control Box (3 Receiver).....	1.75	2.75	
BC-451 Control Box (Transmitter).....	.99	1.49	2.29
BC-442 Relay Unit (ANT).....		4.95	
Flexible Shafting with gear to fit receivers.....		1.75	
3 Receiver Rack.....	1.49	1.99	2.75
Shock Mount for Receiver Rack.....		.99	
2 Transmitter Rack.....		3.49	
Single Transmitter Rack.....		2.99	
DM-33 Dynamotor for Command Set.....		3.95	

PRICES SLASHED!!

HS-33 HEADSET used.....	\$1.49
ENGLISH TYPE, TL-55.....	.10
FL-5 RADIO FILTER used.....	.49
CR-1A/AR CRYSTALS—8036.25KC, 8001.43KC.....	
8258-57KC—Brand New.....	each .49
BC-434 Control Box.....	New 3.95

SAVE! SCR-522 RECEIVERS

less oscillator assembly, frequency shifter and tubes. Contains all Coils, Transformers, Resistors, Condensers and other valuable parts. **\$4.95**

SPECIAL! 2 for \$8.00

MULTI-TESTER FOUNDATION BIAS METER

1-97A Complete, Brand New. **\$4.49**

Special



Field Telephones

Army surplus, plus, completely reconditioned and electrically tested, using 2 flashlight cells and a pair of interconnecting wires. GUARANTEED. Like new. **\$19.95**

TELEGRAPH KEYS

J37.....	\$.99
J38.....	.99
J41.....	.99
J45.....	2.99

HEADSET ADAPTER MC-385

Used with headsets HS-33 or HS-35—raising the impedance from low to high. Comes complete with PL 55 PLUG. **ONLY 49c**

HEADSETS

HS-23 high impedance—BRAND NEW with ear pads.....	\$4.65
HS-33 low impedance—BRAND NEW with ear pads, cord and PL54 PLUG.....	5.65
CD-307A Cords, 6 ft.....	1.10
HS-16 high impedance—used.....	.98

MICROPHONE SUPER-SALE

T-44 MIKE—magnetic type consisting of Mike Unit MC-253, Cord CO-287, Plug PL-179 and Jack JK-29.....	\$1.19
T-45 MIKE—Carbon Lip Mike, Navy Type.....	1.25
T-17 MIKE—Carbon—Excellent Cond.....	6.95

TUBES 60% TO 90% OFF LIST! TUBES

SPECIAL-OF-THE-MONTH! 1213—20c ea. 6 for \$1.00 Same as 1644 tube.

2B22.....	.29	215A.....	.09	837.....	.99
2C25.....	.09	221A.....	.19	841.....	.19
2C26A.....	.09	316A.....	.19	843.....	.15
3B22.....	.89	388A.....	.49	864.....	.19
3D6.....	.29	471A.....	.99	1626.....	.19
7D4.....	.29	532A.....	.99	7193.....	.19
1213.....	.35	722A.....	.79	E1148.....	.39
15R.....	.19	826.....	.29	RK34.....	.79
39/44.....	.19	835.....	3.50	VT127.....	.09

MINIMUM ORDER \$2.00

Immediate delivery—send 25% deposit on C.O.D. orders. If sending full remittance, allow for postage and save C.O.D. charges. All shipments F.O.B., N.Y.C. warehouse. (N.Y.C. residents add sales tax.)

PLATT ELECTRONICS CORP.

Dept. A, 125 West 17th St., N. Y. 11, N. Y.
 PHONE: CHelsea 2-1100

Cascade TV Booster

(Continued from page 41)

The only critical part of the whole circuit is in the grid coupling and this is "cut-and-try" which varies with different types of TV sets, antennas, and transmission lines. Consideration will have to be made to allow for adjustment of coupling L_5 to L_4 .

The power supply rectifier circuit supplies a potential of 200 volts to the 12AT7 tube circuit. It is possible to obtain up to 250 volts with this circuit by reducing the value of R_4 , but the extra voltage will not increase the gain in this instance and may cause the booster to oscillate and become unstable.

It must be remembered in building this booster that the original model was built with only channels 4 and 5 to work with and that there will be some slight variations in the tuned sections of the circuit if used on different channels. Tuning capacitor C_6 will definitely cover all the lower channels (2 through 6) when used with L_4 as specified. If used on channels 7 through 13, L_4 will have to be modified. The only other modification needed for the booster to tune down to channel 2 will be additional capacity in place of C_2 , probably in the vicinity of 100 μfd . If used on channels 7 through 13, the inductance of coils L_1 , L_2 , and L_3 will have to be reduced.

For the TV band covering channels 7 through 13, capacitors C_{11} , C_8 , and C_9 should be changed from 30 μfd . to 15 μfd . "Ceramicons" should still be used. Also, C_6 should be changed to a 2 to 15 μfd . variable. For the high band, L_5 should consist of a hairpin loop $2\frac{1}{2}$ inches long with a separation between the wires of $\frac{1}{4}$ inch. Inductance L_4 should consist of a hairpin loop $1\frac{1}{8}$ inches long with $\frac{1}{4}$ inch spacing between the wires. L_1 and L_3 should lie parallel to each other with $1/16$ to $1/8$ inch spacing between them, depending on the strength of the station signal.

The reason L_5 is made longer than L_4 is that this is a convenient length

for L_5 to go through the hole in the deck to connect to the switch below. The resonant frequency of L_5 is relatively unimportant. The main thing to contend with is matching the impedance of the transmission line to the input coil L_4 , and this will vary with the amount of coupling.

The other coils must be changed for operation on the high band. L_1 should consist of 2 turns with an inside diameter of $5/16$ inch, L_2 should be 1 turn with an inside diameter of $5/16$ inch, and L_3 should be 1 turn with an inside diameter of $5/16$ inch. Some type of switching arrangement can be incorporated to operate the booster on both the high and low bands if desired.

The chassis of the booster should not be grounded nor should the chassis be touched while in contact with a grounded object as a potential exists between the booster chassis and ground. That is also why the cabinet should be constructed of wood as shown in Fig. 1, to eliminate the possibility of someone accidentally getting shocked. Also, care should be taken that neither the antenna lead-in nor the input connections to the television set come in contact with the chassis of the booster.

The three 2000 ohm, 10-watt dropping resistors R_8 , R_9 , and R_{10} , in series with the heater of the 12AT7 tube will radiate a certain amount of heat so, if a back is used on the booster, it should have a few holes in it to allow for air circulation. A step-down transformer could be used here in place of the resistors but one small enough to be placed on the chassis was not available at the time.

Another tip to remember when trying this booster is that the circuits generating the sync signals in the set may radiate outside of the television cabinet and be picked up in the lead-in and smear the picture. Moving the lead-in around to a different position may eliminate this. Also, trying different lengths of lead-in between the booster and the television set may make a difference. In this particular instance, a half-wavelength at the desired frequency was found to be best for all around stability and best performance.

-30-

Fig. 3. Bottom view of the booster showing hole for L_5 connection to switch.

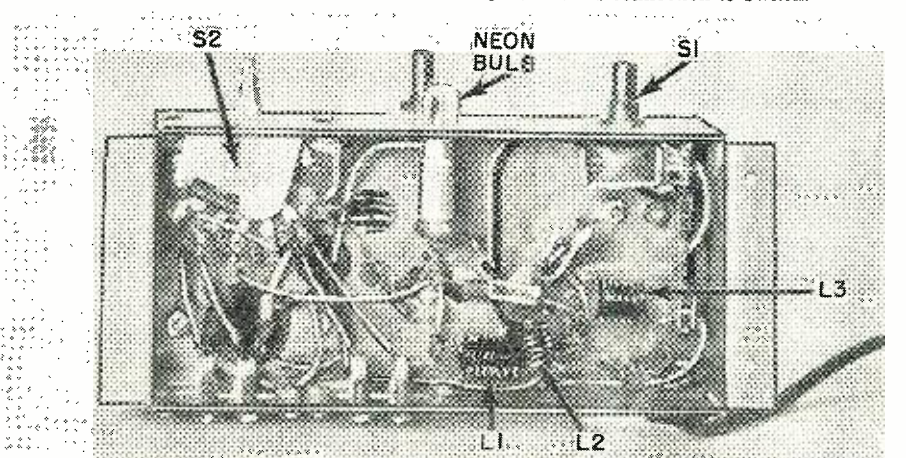

FREE

TELLS HOW—
WE GUARANTEE
 TO TRAIN YOU AND COACH YOU
 AT HOME UNTIL YOU GET
YOUR FCC LICENSE

if you have had any practical radio experience—
 amateur, Army, Navy, radio repair, or experimenting

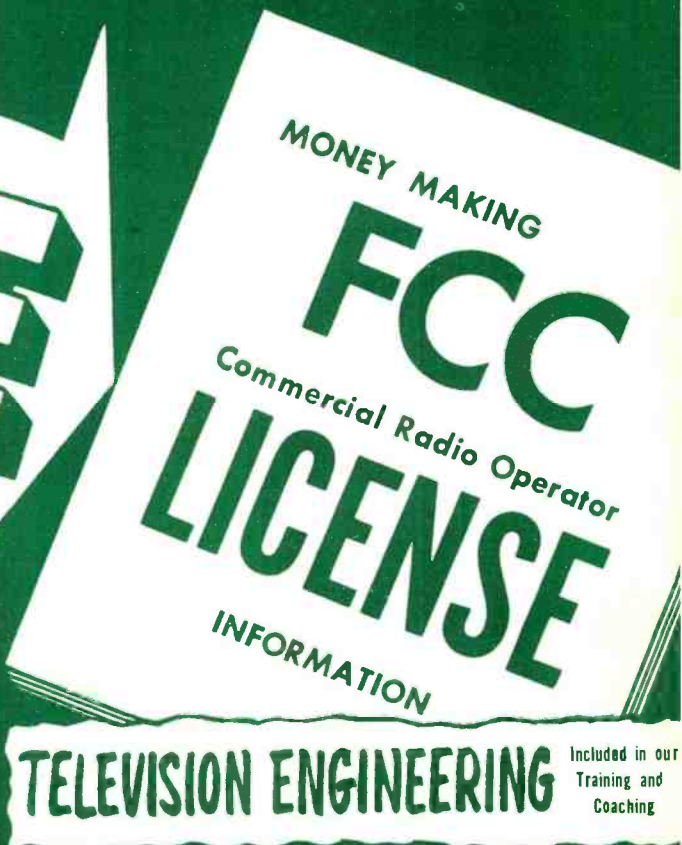

Included in our
 Training and
 Coaching

**TELLS HOW— Our Amazingly Effective
 JOB-FINDING Service Helps CIRE Students
 GET BETTER JOBS**

AIRLINES

"I am beginning a new job with Capital Airlines in Washington, D.C. I will start as a radio mechanic. I got the job through your school and want to thank everyone concerned."
 Arthur Dohmer, Alexandria, Virginia

BROADCAST STATIONS

"I have received three offers from having my name on your "available list". Also one Chief Engineer contacted me after he saw my name in your monthly Electron Bulletin as having received my first phone license. I accepted a job with KWHW."
 Don Calderwood, Altus, Oklahoma

CIVIL SERVICE

"I have obtained a position at Wright-Patterson Air Force Base, Dayton, Ohio, as Junior Electronic Equipment Repairman. The Employment Application you prepared for me had a lot to do with my landing this desirable position."
 Charles E. Loomis, Dayton 6, Ohio

INDUSTRY

"I now have a job with the Glenn L. Martin Co., which I got through your Job Finding Service. I am doing maintenance and calibration work on electronic test equipment. Thanks for your help and training."
 H. W. Hamrick, Baltimore 20, Md.

Your FCC Ticket is recognized by employers in the electronic field as proof of your technical ability.

ACT NOW!

Mail This Card Now
 NO POSTAGE REQUIRED

Get All 3 FREE



I want to know how I can get my FCC ticket in minimum of time. Send me your FREE booklet "How to Pass FCC License Examinations" (does not cover exams for Amateur License) as well as sample FCC type exam and the amazing new booklet, "Money Making FCC License Information".

B

NAME _____
 ADDRESS _____
 CITY _____
 ZONE _____ STATE _____

Special tuition rates to members of the U.S. Armed Forces

SEE OUR AD ON NEXT PAGE

**TELLS HOW— Employers Make JOB OFFERS
 Like These To Our Graduates Every Month**

Letter from nationally-known Airlines:

"Radio Operators and Radio Mechanics are needed for our company. Periodic wage increase with opportunity for advancement. Both positions include many company benefits such as paid vacations, free flight mileage allowance and group insurance."

**HERE'S PROOF FCC LICENSES ARE
 OFTEN SECURED IN A FEW HOURS OF STUDY
 WITH OUR COACHING AT HOME IN SPARE TIME**

Name and Address	License	Time
Harry G. Frame, Box 429, Charlestown, W. Va.	2nd Class	13 Weeks
Charles Ellis, Box 449, Charles City, Iowa	1st Class	28 Weeks
Omar Bibbs, 1320 E. 27th St., Kansas City, Mo.	1st Class	34 Weeks
Kenneth Rue, Dresser, Wisconsin	2nd Class	20 Weeks
B. L. Jordan, Seattle, Washington	1st Class	20 Weeks

Letter from nationally-known manufacturer:

"We have a very great need at the present time for radio-electronics technicians and would appreciate any helpful suggestions that you may be able to offer."

These are just a few examples of the job offers that come to our office periodically. Some licensed radioman filled each of these jobs; it might have been you!

Ours is the only home study course which supplies FCC-type examinations with all lessons and final tests.

CLEVELAND INSTITUTE OF RADIO ELECTRONICS

Desk RN-72 4900 Euclid Building, Cleveland 3, Ohio

CARL E. SMITH, E.E., Consulting Engineer, President



Want To Double Your Pay?

I can train you to pass your FCC License Exams in a minimum of time if you've had any practical radio experience—amateur, Army, Navy, radio servicing, or other. My time-

proven plan can help put you, too, on the road to success. Just fill out the coupon and mail it. I will send you free of charge, a copy of "How To Pass FCC License

Exams," plus a sample FCC-type Exam, and the amazing new booklet, "Money Making FCC License Information." **CARL E. SMITH, President**

How To Pass FCC COMMERCIAL RADIO OPERATOR LICENSE EXAMINATIONS

MONEY MAKING FCC COMMERCIAL RADIO LICENSE INFORMATION

TELEVISION ENGINEERING
Included in our training and coaching

HERE IS YOUR GUARANTEE

Should you fail the FCC commercial license examinations after completing your course, we guarantee to continue your training without additional cost of any kind, until you successfully obtain your commercial license, provided you first take your examinations within 90 days after completing course.

Add Technical Training To Your Practical Experience

Which Do You Want?

BETTER PAY

A Nice Home

A New Car

Happy Vacation and Travel

Greater Security

IMPORTANT
SEE OTHER SIDE FOR MORE INFORMATION

If You Don't Act Now And Learn More

Six months from today

Which Will You Hold?

this- **EXAM FAILED**

or this **1st CLASS FCC LICENSE**

MAIL CARD AT ONCE—GET FREE BOOKLETS

If You're in the Armed Forces PLAN NOW for PRESENT and FUTURE SECURITY IN CIVILIAN LIFE

- 1 Use your spare-time, NOW, while you are in the armed forces, to prepare for the FCC license examinations, and get your FCC Commercial License.
 - 2 Shortly before discharge, use our **AMAZINGLY EFFECTIVE JOB-FINDING SERVICE** to get your choice of good-pay jobs.
- Special tuition rates to members of the U.S. Armed Forces.

FORMER NAVY MAN GETS JOB AT COLLINS RADIO

"Since my discharge from the Navy, I have been working for Collins Radio Company at Cedar Rapids, Iowa, one of the job opportunities you listed. I am giving a lot of credit to your course for helping me in passing the qualifications exam at Collins."
Howard Johnson, 990 Seventh Avenue, Marion, Iowa

NORTH AMERICAN EMPLOYS EX-ARMY MAN

"I am employed by North American Aviation as an electronic technician. Their name was received from you while I was in the service overseas. The lessons I completed played a big part in helping me pass their screening examinations."
Vernon Skovgaard
1801 S. Kingsley Dr.
Los Angeles 6, Calif.

Postage Will be Paid by Addressee

No Postage Stamp Necessary If Mailed in the United States

BUSINESS REPLY CARD
FIRST CLASS PERMIT No. 8685, Sec. 34.9, P.L. & R. Cleveland, Ohio

Cleveland Institute of Radio Electronics

4900 EUCLID AVENUE

CLEVELAND 3, OHIO

Desk RN-72

TEAR OUT AND MAIL THIS CARD NOW!

INEXPENSIVE TONE GENERATOR

By ROBERT J. ROPES, W9PAP

THIS tone generator, when added to the present speech amplifier, greatly increases the operator convenience when making adjustments to the transmitter or the modulator. It is especially useful to the single-sideband operator, in adjusting for the proper modulator balance, etc. The circuit is an adaptation of the famous Wien-bridge oscillator, and requires only one tube, three capacitors, four resistors, and a d.p.s.t. switch. It can be added to the present speech amplifier for several dollars, and will prove to be worthwhile to any ham.

The two capacitors, C_1 and C_2 should be silvered mica, and the two 1 megohm resistors, R_1 and R_2 , should be picked with an ohmmeter for a matched pair ($\pm 2\%$). By substituting a 10,000 ohm potentiometer for the 5000 ohm resistor (R_3), it is possible to degenerate the plate circuit for pure sine-wave operation. This condition will occur when the pot is adjusted just beyond the point where oscillations start, and the oscillator becomes stable. An added refinement (for those who demand absolute stability) is the substitution of a 117-volt, 6-watt bulb for the cathode resistor, R_4 . The bulb becomes, of course, a "thermistor" which automatically adjusts the cathode bias, and thereby regulates the amplitude of the output voltage.

Capacitor values are given for several other frequencies, since operation may be desired at other frequencies. If a frequency higher than 1600 cps is desired, the one megohm resistors should be reduced in value, and the capacitors kept at approximately 100 μfd . for greatest stability. An important rule of thumb here is to remember the fact that to double the frequency, the capacitor values at C_1 and C_2 or the resistance values at R_1 and R_2 (but not both) must be halved.

The output voltage for 400 cps sine-wave operation is approximately 13 volts at the high impedance connection, and approximately 2 or 3 volts at the low impedance connection at the cathode.

By throwing S_1 , the tone modulation can be switched "on" and "off" at will. Although the author has not keyed this oscillator, it is possible that it could be used in the proper bands for modulated continuous wave operation.

-30-

Schematic diagram of the simple and inexpensive tone generator. See text for variations which can be made in circuitry.

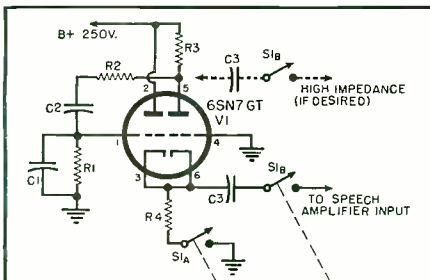

R_1, R_2 —1 megohm, $\frac{1}{2}$ w. res. (matched $\pm 2\%$)
 R_3 —5000 ohm, 2 w. res. or 10,000 ohm pot (see text)
 R_4 —330 ohm res. or 6 w., 117 v. bulb (see text)
 C_1, C_2 —400 μfd . silver mica capacitor (for 400 cps); 200 μfd . silver mica capacitor (for 800 cps); 100 μfd . silver mica capacitor (for 1600 cps)
 C_3 —.5 μfd . paper capacitor
 S_1 —D.p.s.t. switch

WHOA, Mr. Serviceman!

DON'T JUST REPLACE—

MODERNIZE

with wide-range, high-compliance

SONOTONE

TITONE CERAMIC CARTRIDGES

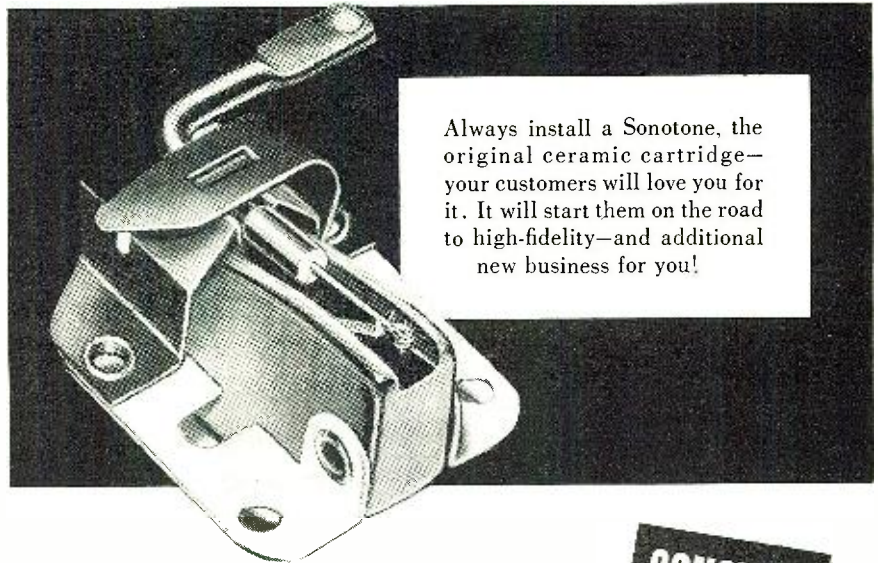

Always install a Sonotone, the original ceramic cartridge—your customers will love you for it. It will start them on the road to high-fidelity—and additional new business for you!

Write for free Sonotone manual today!

New Sonotone Phonograph Modernization Manual includes an up-to-date cross reference and phonograph model index, fully explains how to use Sonotone Ceramic Cartridges. Send coupon below for your free copy, now!



ELECTRONIC APPLICATIONS DIVISION

SONOTONE CORPORATION

Elmsford, New York

SONOTONE CORPORATION
Elmsford, N.Y.

Dept. (N)

Please send me a free copy of the Sonotone Phonograph Modernization Manual

Name _____

Address _____

City _____ State _____

REPLACING TV PARTS

By ART MARGOLIS

Here are some TV service cases showing what can happen if the exactly correct replacement parts are not used.

WHAT do you do when the needed tube is not in your caddy? How hard do you try to replace a shorted capacitor with the same type? How far do you search for an exact replacement transformer? How much trouble will you go through in obtaining the correct yoke? The messy confusion of replacement parts causes hair-pulling extra bench hours and a great percentage of costly callbacks. A careful handling of the replacement problem can pay off in cold hard cash.

But what is an intelligent approach? Should you religiously follow instructions and obey such things as the emphatic wording on tubes, "Insist on only genuine (blankety blank) replacement?" Or should you sneer at the devil and pull filters out of the ancient junker lying in the corner?

With over three hundred different parts in each TV receiver and with the literally thousands of different makes and models in operation today, always having or being able to get a correct replacement can cause the TV service technician much gnashing of the teeth.

Tubes

The TV technician has a "must carry" list of over one hundred different TV receiving tubes. This can cause even a simple case of tube pulling to get complicated.

One of our technicians was out repairing a *Philco* model 1000. The symptom was sound but no raster. Checking through he found a cold 5V4 damper. As luck would have it, he had used his last 5V4 on a previous job. Being a resourceful chap he inserted a 5U4 instead. The brightness popped on. The customer was joyful, that is, until the next day, when she called in again. Another technician rushed over and discovered these new symptoms. A commentator was talking to the TV audience. One of his shoulders extended only a tiny way from his neck while his other shoulder stretched out like an inflated balloon. If he was the only misfit, it would have been OK, but a station break revealed more people with this unique build.

The technician after adjusting and checking and swearing, finally located the misplaced 5U4 and inserted a 5V4. The people on the screen looked human once more. The 5U4 in the role of a damper had presented a different resistive load to the horizontal sawtooth circuit and was distorting the horizontal linearity.

You have to be careful with these tube swaps. They are the cause of quite a bit of technician "induced" trouble.

Our company was called upon to service a 12" *Silvertone*. The technician found the set symptom to be no horizontal or vertical sync. After checking through he found a defunct 7AF7 sync tube. But his box was devoid of 7AF7's. Shrewdly he inserted a similarly pinned 7F7. The sync condition cleared up. The customer smiled at first, but then grew sour again. The newly locked-in picture had a classic example of what a weave should really look like. The TV performers were marvelously pretzel' bent. A half hour and ten ounces of perspiration later the technician pulled the chassis to the shop.

The bench man spent about three hours scouring the circuitry. Then for lack of anything else to do he pulled out the recently-installed high-mu 7F7 and replaced it with a new medium-mu 7AF7. The weave bid a belated adieu.

We can't just indiscriminately change tubes. That's only asking for it. However, if we're sure of our moves and employ some foresight, it can be done.

We received a call to service a 16" *Philco*. The service technician discovered that channel three was coming in weak, six was even weaker, and ten (all Philadelphia channels) was nowhere in sight. A preliminary check revealed the 12AV7 local oscillator-mixer was nearly shot. He put in a replacement 12AT7. This slightly different tube shifted the frequency, making ten show up on eleven. A little trimming of the oscillator coils, however, set all three channels exactly right.

Capacitors

Although simpler than tubes, the capacitor situation is complicated by a

multitude of sizes, shapes, capacitances, and working voltages. Let your guard down for a minute and the little "buggers" will slip a callback in on you.

One 17" *RCA* came into the shop without enough high voltage. Only a slight arc could be drawn off the 1B3 and it wouldn't light up. A few checks into the circuit showed an 8.2 μfd . capacitor broken open. It was in the horizontal output plate leg of the high voltage transformer, blocking it off from normal "B+." See Fig. 1. A new 8.2 μfd . capacitor had the high voltage singing once more.

The set was delivered, but a few days later the customer called in again, same trouble. A technician was dispatched armed with another 8.2 μfd . It was the same trouble and he soon had the set perking. But a few days later the customer called in again. We called a halt to these proceedings and went into a huddle over the schematic. One brain noted a 3000 volt difference on either end of the capacitor. The *RCA* distributor provided us with an 8.2 μfd . condenser at 5000 working volts and the set has been providing entertainment ever since.

Make a false move and you sentence yourself to extra bench labor. A 12" *Westinghouse* came into the shop with insufficient vertical sweep. Checking through the vertical circuits, a 150 μfd . filter capacitor in the vertical output cathode was found to be wide open. See Fig. 2. The condenser drawer had had particularly heavy traffic that week and there weren't any 150's left. The bench man installed a forty. After all, once you get above ten or twenty "mikes," they're all the same anyway. The picture with renewed vigor swept out vertically most of the way. Only a slight space remained top and bottom. The technical expert began manipulating the vertical linearity and height controls. Excellent foldover resulted, but no more sweep. The bench man then accumulated about two hours' experience traveling through the vertical circuits. Finally he completed the journey by arriving back at the vertical output cathode. In desperation he left the shop and picked up a 150 μfd . capacitor. Yep, that puffed the picture the rest of the way out. The smaller value filter had a definite degenerative effect on the low 60-cycle vertical saw-tooth. Despite this case, however, if you're careful you can make changes that will save time and labor and not result in tragedy.

A 16" set came limping into the shop. After playing about five minutes it would start rolling vertically. Suspecting the vertical oscillator grid condenser, it was changed. A .001 for a .0015. It was a good diagnosis for the roll was no more. However, the vertical hold was now locking at one extreme end. The technician located a resistor in the grid of the

Fig. 1. Part of a 17" *RCA* TV set high voltage circuit showing capacitor that requires the 5000 working volt rating.

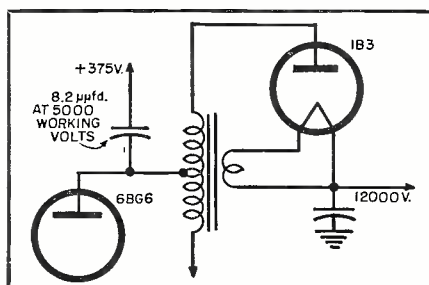

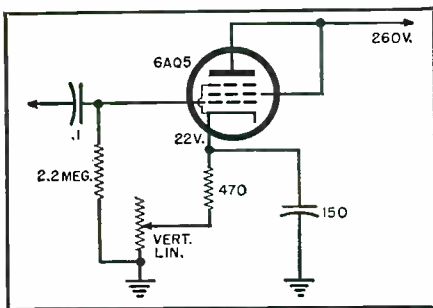

Fig. 2. Vertical output circuit of a Westinghouse receiver showing the critical capacitor in the tube's cathode.

vertical oscillator. The resistor and capacitor comprised the 60-cycle time-constant network for control of the vertical frequency. Juggling the resistor value soon had the vertical hold locking in the picture when set in the center of the vertical hold pot.

Transformers

A 16" department-store special came into the shop. The symptoms revealed no high voltage but there was "B+" on the plates of both the horizontal output and the high voltage rectifier. A reading of the damper's cathode revealed "B+" but no boost. Scope checks of the horizontal oscillator pictured a saw that would cut wood. Bias voltage on the horizontal output grid was correct. A static check of all the parts in the high-voltage system from the grid of the output tube to the picture tube well, showed everything in order. I would have sworn my test equipment was fibbing, but I couldn't argue with the plain fact of no raster.

I went into the low voltage power supply, but found no defects. I checked off the boost "B+" destinations such as the vertical output, still nothing. Then I chucked my meters, picked up the solder gun and began substituting parts. Hours later I tacked in a new flyback. The high voltage came on. I felt like Franklin discovering electricity and eased back on the stool for the routine task of physically installing the electrically perfect transformer. But there was nothing routine about it for this monster didn't faintly resemble the original. I cross indexed three more manufacturers. All three of them had an entirely different transformer, none of which was at all similar to the original. The set manufacturer was halfway across the country and the customer was calling every hour like an anxious parent. To make a long story short, I had to redesign the setting of the 1B3 and high voltage capacitor. In my book, out of all the replacement headaches, this physical mounting of strange high-voltage transformers is the most time wasting.

A low-voltage transformer can cause a picnic too. A 21" Muntz came into the shop. It was continually popping out the 5 ampere "Slo-Blo" fuse. The low-voltage transformer's secondary was found shorted. A new "direct" replacement was tacked in and the set came on. As

an added attraction the 6BQ6 was running with cherry red plates. But that was easily taken care of when the 6BQ6's screen dropping resistor was found to have changed from 8200 to 1500 ohms. After cooking the set for a couple of hours the transformer was permanently mounted. Everything was fine except the benchman could no longer get the high-voltage cage back on for its slots were covered. He could not insert the 5U4 in its socket because now the picture tube was in the way. Fortunately, there is a new skinny 5U4 that just about fits but those high-voltage tubes now require lots of ventilation.

Yokes

Changing yokes can be a tricky business. A 12" receiver came into the shop with no high voltage. After a few hours of circuit scouring the vertical section of the yoke was found shorted to ground as shown in Fig. 3. You ask, what has this to do with high voltage? Well, the yoke is in the "B+" line of the vertical output tube.

The "B+" for the vertical output stage is derived from the boost "B+" provided by the damper. The shorted yoke was killing the damper voltage which was, in turn, stopping the fly-back action needed for the production of the high voltage.

After this electronic strategy was concluded we sent over to a nearby distributor for a yoke, designating it by set model number. Soon the picture was shining brightly out at us from the CRT but with insufficient width. And nothing we could do would stretch it out any more. After many time consuming checks we determined that the new yoke was at fault. The impedance of the horizontal section did not match the horizontal output transformer correctly. Only a new direct replacement from the factory distributor ten miles away cleared the situation.

Sometimes you can outsmart replacement problems. A 19" Emerson came into the shop with no vertical sweep. An open vertical section was found in the yoke. A new replacement yoke was taken off the shelf and in-

Fig. 3. The short in the vertical yoke of this circuit eliminated the high voltage for the entire receiver. See text.

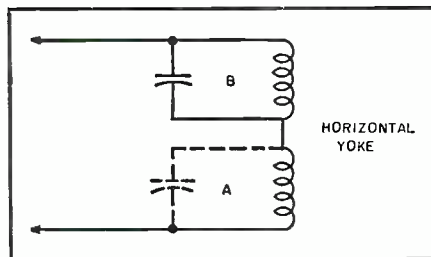
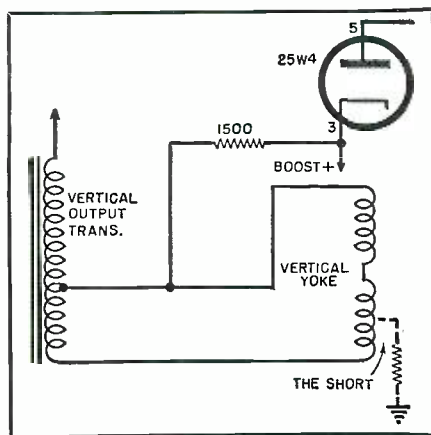

Fig. 4. Severe ringing, resulting when the faulty CRT yoke was replaced, was eliminated when the balancing capacitor formerly at "A" was rewired across "B"

stalled. Our setup picture tube revealed perfection. The receiver was sent out for delivery.

The technician installed the repaired TV set. He mounted the yoke and focus assembly on the picture tube that had never left the cabinet and inserted the chassis. Then he turned on the set. The customer yelled, "The picture is upside down!" Sure enough, it was, but being an extremely clever chap he noted the yoke assembly had been designed to sit in an unorthodox upside down position. Digging into his mental resources he reversed the vertical yoke leads. The picture came in right side up. He beamed in satisfaction at his prowess but the customer screeched, "The words are reading backwards, like a mirror!" The service technician confidently reached into the set and resoldered the horizontal leads on opposite terminals. The words came in correctly reading from left to right. However, the horizontal reversing created a serious ringing condition on the left side of the picture. No amount of horizontal alignment would clean it up. Then the service technician pulled out the yoke and removed the horizontal balancing capacitor. This he re-installed on the reverse section of the horizontal yoke. The picture drove in beautifully.

Our company has found that in the case of the standardized items such as receiving tubes, regular capacitors, resistors, etc., one first-quality brand name will perfectly replace another. However, when it comes to the many special parts in the TV set, such as odd capacitors, transformers, i.f. cans, etc., considerable care and ingenuity should be used in providing exact replacements.

No matter how agonizing it is to make the correct replacement, it is much easier than having to replace a dissatisfied customer. -30-

NEW FILM ON TV REPAIR

A NEW one-minute movie telling the TV service technician's story to the public has been produced by the G-E Tube Department for TV showings.

In the film, actor Bob Dixon explains the complexity of TV sets with their over 500 different parts, and notes that a service technician must know how to repair many different makes.

The film is available to tube distributors for local showings. -30-

New Year's News from Hallicrafters

CHICAGO 24, ILLINOIS

IN CANADA: BOX 27
TORONTO 17, ONTARIO

Model HT-30 SINGLE SIDEBAND TRANSMITTER/EXCITER

- Highly stable VFO with full 100:1 ratio gear drive system built-in.
- Stability comparable to most crystals .01%.
- Ample gain for 55 db microphone with hum and noise 40 db down.
- Full 40 watt lineal peak power output.
- Unwanted sideband at least 40 db down.
- Undesired beat frequency down 60 db or more.
- T. V. I. suppressed.
- Provisions for coaxial output fitting.
- Built-in voice control circuit with bias switching for final amplifier.
- AM-CW-SSB-19 tubes plus voltage regulator and 2 rectifiers.



WHAT'S

New in Radio

The products described in this column are for your convenience in keeping up-to-date on the new equipment being offered by manufacturers. For more complete information on any of these products, write direct to the company involved.

NEW TV ROTATOR

Trio Manufacturing Co., Griggsville, Ill. has announced the availability of a new television rotator, the "Aristocrat."

The rotator features a control unit which is new both in design and appearance. An illuminated dial is the only visual indication that this is a ro-



tator control unit. There are no knobs or switches on the front. The "on-off" switch and direction switch are located on the rear panel of the cabinet for easy, natural fingertip operation. The control unit is available in either blonde or mahogany finishes.

VOLTAGE BOOSTER

Service Instruments Company, 422 S. Dearborn, Chicago, Ill. is now offering a new step-up model of its "Up-Down" line voltage booster.

The new model, which is also designed to increase line voltage for TV receivers by 10 volts, reduce it 10 volts, or restore it to normal when turned off, has a NE-51 neon indicating lamp. A potentiometer located under the output receptacle is adjusted at the factory so that the light will glow if the line voltage rises to 128 volts and will stop glowing if the line falls below 126 volts. The neon circuit acts as a warning signal to indicate that the line voltage has increased to a level detrimental to the TV receiver's tubes and components.

V.H.F. ANTENNA

The Winegard Company, 3000 Scotten Blvd., Burlington, Iowa has added another unit to its antenna line.

The new model is an all-channel v.h.f. antenna which retails in the moderate price class. Tradenamed the "Pixie" (Model L-5), the new antenna is streamlined for good appearance and low resistance to wind. It comes packed two to a carton with stacking bars.

NEW SYNCHRO LINE

Clifton Precision Products Co., Marple at Broadway, Clifton Heights, Pa. is in production on a new series of Size 11 synchros.

These instruments feature the high accuracies usually associated with much larger units. Maximum diam-

eter is 1.062 inches and maximum over-all length is 1.702 inches. Weight of the synchros is 3.1 ounces.

The new line is available with leads or can be specially ordered with radial or axial terminals. The dielectric insulation between windings and case is rated in excess of 500 volts a.c.

The line is available in the following types: signal generators, receivers, regular and high-impedance control transformers, high-output control transformers, control differentials, resolvers, and sine-cosine generators.

Data sheets on each type are available on request.

SWEEP GENERATOR

Radio City Products Company, Inc. of Easton, Pa. has developed an all-electronic sweep generator which has been specifically designed with the needs of the TV technician in mind.

The Model #780 features complete electronic circuitry, a unique unidirectional coupling which sweeps in one direction only, multiple shielded push-button attenuator, and detector/comparator output.

The range is from 3.2 mc. (for color TV) to 900 mc., covering u.h.f. with good sweep linearity characteristics.

JACK-PLUG COMBINATION

The design and production of a sub-miniature closed-circuit jack and plug combination which is suitable for numerous audio and electronic applications has been announced by *Telea,*

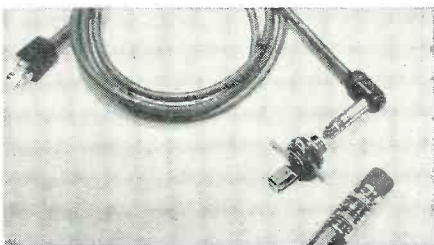

Inc., 1633 Eustis Ave., St. Paul, Minn.

Approximately $\frac{1}{8}$ the size of previous models, the phone-type unit can be used in computers, tape recorders, dictating machines, and miniature radios. The jack can be mounted in any panel up to $\frac{1}{8}$ " in thickness. Over all length of the plug is $\frac{3}{4}$ " with a diameter of $\frac{9}{64}$ ". In the current model the plug is molded directly on the cord but detachable cords are being developed for later availability.

"ONE-WAY ANTENNA"

JFD Manufacturing Company, 6101 16th Avenue, Brooklyn 4, N. Y. has developed a one-way TV antenna which has been named the "Shut-Out."

OLSON'S PENNY PROFIT POLICY MEANS GREATER BARGAINS

NEW WEBSTER-CHICAGO (Webcor) All-Speed Automatic Diskchangers



With Crystal Turn-over Cartridge and Precious Tip Needles. **STOCK NO. RA-157 \$28.95**

With GE V.R. Turn-about Cartridge and Precious Tip Needles. **STOCK NO. RA-158 \$32.95**

Now you can save \$20.00 on the latest model Webcor record changers. Your choice of either model. Ideal for use with Espey Chassis or any radio, amplifier or TV set installation.

Plays a 1" stack of 7", 10" or 12" records at 33 1/3, 45 or 78 RPM. Features include automatic adjustment for any dia. record stack, improved spindle and automatic shut-off after last record. For 115 V. AC cy. Base size 13 3/4" x 12" x 8 1/4". Shpg. wt. 13 lbs. Webcor Mounting Base—**STOCK NO. X-363, each \$4.95.** Shpg. wt. 3 lbs.

SALE! ONLY 200 AMPLIFIERS

8-Watt Peak Output



Stock No. AMP-21 **\$18.07**

A fine amplifier and we figured your cost down to the last penny. We have only 200. Given full clear tones. Look at these features which are found on much more expensive instruments. Inputs for BOTH resistance cartridge or crystal cartridge. Also handles a radio tuner and a crystal microphone. Has built-in pre-amplifier, keyed with output transformer. Excellent volume control, tone control and switch. Has power outlet for record player motor which shuts off automatically when amplifier is turned off.

Delivers 5 watts continuous. Completely assembled with matched parts and wired. Ready for use. Tubes included: 6SL7 (Dual Tube), 6V6 and 6X5. Chassis is heavy gauge and beautifully finished. Size 9 1/2" x 7" x 6". Shpg. wt. 12 lbs.

EXTRA: Included is a transparent plastic engraved and drilled front panel which can be mounted on any cabinet.



Price Slashed on Famous CUSTOM "GROMMES" JEWEL AMPLIFIER

5 Tube Model LJ-2—18 Watt Peak with Built-In Pre-Amp

Over 3000 of these popular high fidelity amplifiers have been sold at the regular price of \$44.75. Every user is happy. Here is your chance to get the same amplifier, brand new in factory sealed carton for only \$28.87—less than the cost of the parts. The factory decided to change the color and size of the chassis and we bought their entire stock.

Peak Power, 18 watts. Distortion at 8 watts, 1 1/2% harmonic or 7% intermodulation. Frequency response 1 dB at 3 watts, 3 inputs, radio or crystal phono, magnetic phono and microphone. Bass and treble controls. Output 4, 8, 16 ohm. Complete with Tubes 6SC7, 6SL7, 2-6V6 and 6X5. Size 10 1/2" x 6 1/4" x 5 1/4". For 115 Volt AC. Shpg. wt. 13 lbs.

RUSH YOUR ORDER TODAY—OFFER WILL NOT BE REPEATED.

Type 39/44 R.F. Amplifier Pentode Tubes

Brand new original factory packing. 1 tube to a carton, 50 to a case. Stock up on this Regular \$2.80 list tube at less than a dime a piece. Manufactured by Tung-Sol, RCA and General Electric. 6.3 V.—3A. Shpg. wt. (6)—2 lbs.

STOCK NO. Z-228
6 FOR 67c
CARTON OF 50 ONLY \$4.77

"Powerfone" Gradle-Phone

Self-powered with Built-in Buzzers

Complete two phone system **\$5.95 SET**

3 complete sets, each . . . \$4.95
6 complete sets, each . . . \$4.50
12 complete sets, each . . . \$3.95

Works up to one mile. Durable, dependable. Lifetime electro-magnet earphone. Gold-plated diaphragm carbon mike. Connects in 2 seconds—place on table or mount on wall. Complete—you get 2 batteries with built-in buzzers, 2 cradles, 2 batteries, 50 ft. double cable. Handsome Gift Carton. Money-back Guarantee if not twice as good as you expected! Shpg. wt. 4 lbs.

ROYAL DYNAMIC MICROPHONE

STOCK NO. M-89

\$4.95

Built-In Western Electric Unit

Olson is the first to bring you this new pencil type microphone coupled to a Western Electric Dynamic unit. It is internally mounted High Impedance Transformer. Matches any amplifier which is designed for crystal, dynamic or ribbon mike. Only 1 1/2" diameter. Base swivels and is removable so mike can be hand held. Satin gray finish with 5" shielded cable. Shpg. wt. 2 lbs.

OLSON SPECIAL—232 RESISTORS KIT

Value packed with 200 1/2-watt, 20-1 and 2 watt; and 12-5 to 25 watt wire-wound resistors. Includes 232.50, .5-10-20% tolerances. Includes IRC, Claret, Stat, Centralab, etc. 100% Ohm Guaranteed. Shpg. wt. 2 lbs.

STOCK NO. AS-84 **\$3.95**

CATHODE RAY 'SCOPE TUBE

3CP1/1808P1

BRAND NEW RCA-REG. \$14.50



A 3" Scope at our low price is unheard of. A great value for experimenters, labs, engineers, hams, students, industry, etc. In addition to the usual two pairs electrostatic deflecting electrodes, this tube has a radial-deflecting electrode, which may be used if desired. This arrangement provides for observation and photography of recurrent and transient phenomena in polar coordinates. Medium persistence, green fluorescence.

Full operating instructions and base layout included.

ATTENTION: This is Olson's LEADER VALUE! Never has anyone offered a 3" RCA Scope Tube at less than \$1.00. Offer will positively not be repeated when supply is exhausted. Order Today for Sure. Shpg. wt. 3 lbs.

STOCK NO. Z-230 **99c EA.** 3 for \$2.50

Brand New Radio Transmitter

Signal Corps No. BC-AS-230



Special for Hams & Experimenters

with Tubes R. F. Ammeter **\$5.87**
STOCK NO. RA-198

Now for the first time Olson offers these fine Transmitters with 8 Sylvania Tubes (2 type 45 and 10 type 10)—the type 10 tubes are mica filled bases for low loss. Housed in an aluminum cabinet 11 1/2" x 8" x 6". Chassis is all aluminum, too, and it slides out of cabinet by removing screws. Here is a partial list of the parts this transmitter contains: double speed variable condenser, 2-gang variable condenser, both with micro-tubes, 0-1.5 R.F. Ammeter made by General Electric, 4 Tubes, sockets, oil filled condensers, wirewound resistors, carbon resistors, mica condensers, jacks, binding posts, banana plugs, and miscellaneous hardware. The list price of just the 4 tubes is \$12.00.

Here is a Real Bargain for the experimenter, plenty of parts and tubes for little money. Quantity limited. Shpg. wt. 8 lbs.

GIANT TV ANTENNA KIT

Stock No. AU-24

REG. \$31.95 **\$12.99**

Complete kit—nothing to buy. For best reception on all VHF channels. Rust-proof aluminum. Contains: 2 six-element conical yags, 1 pair of bars, 2 4 ft. R. 1 1/2" mast sections, 60 ft. 300 ohm lead-in, 3 standoff insulators, 2 heavy duty stainless steel and 1 galvanized pipe fitting, 1 clamp assembly, 1 pipe strap, 4 lug bolts and full instructions. Save—order 12 sets—only \$119.50. Shpg. wt. each 13 lbs. Express only.

Electron-O-Jr. Sound System Kit



Stock No. RA-179 Reg. \$19.95

CAN BE ASSEMBLED IN TWO HOURS

Now build and operate a complete 1-tube plus receiver-amplifier P.A. sound system and easily learn principles of electronics. Includes 5" PM Speaker, Dual Electrolytic Condenser, 7.5 and Selenium Rectifier, 3 Resistors, 2 Switches, Volume control and knobs, Input and Output Transformers, Carbon granule Microphone, 12AB7 Tube, 50 ft. 2-conductor Cable, Hook-up wire, Solder and all necessary clips, sockets, hardware, panels and punched forms to make amplifier cabinet and speaker baffle. Simple instruction book included. Operates on 115 Volts AC or DC. Comes in 4-color gift carton. Shpg. wt. 0 lbs.

Nationally Advertised Tester—SUPER METER

Combination Volt-Ohm-Milliammeter PLUS capacity, Resistance, Inductance & Decibels Complete with Instructions and Test Leads. Measures capacity and leakage of paper and electrolytic condensers. Look at all these Ranges—DC VOLTS: 0 to 7.5/7.5/150/1500. AC VOLTS: 0 to 15/150/300/1500. DC CURRENT: 0 to 7.5/7.5/75 MA 0-7.5 AMPS. RESISTANCE: 0 to 10/100/1000-5000 ohms 0 to 10 megs. CAPACITY: 0.01 to 2 MFD. 1 to 20 MFD. REACTANCE: 150 to 25,000 ohms 15,000 ohms to 2.5 megs. INDUCTANCE: .35 to 70 henries 35 to 7000 henries. L.I.T. LEAKAGE: 100,000 ohms 100,000 ohms. DECIBELS: -10 to +18 db. +10 to -38 db. -58 db. Round cornered metal case 3 1/2" x 6" x 2 1/4". Operates on 115 Volts AC. Shpg. wt. 4 lbs.

STOCK NO. TE-47 **\$16.95**

OLSON'S GREATEST VALUE IN TAPE RECORDERS

A REAL PROFESSIONAL PUSHTO AUTOMATIC KEYBOARD MODEL **STOCK NO. AMP-24 \$97.45**

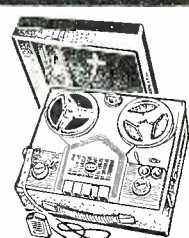

Records—Plays Back—Erases Fast Forward and Reverse All by Pushing Buttons

Dual speed—3 1/4" and 7 1/2" per second. Make recordings with mike or from radio or TV set. 1955 model. Guaranteed retail value \$149.95.

A PROFESSIONAL TYPE TAPE RECORDER at a price every home can afford. Ideal for class room use—perfect for churches, schools, lawyers, musicians, doctors, dramatic societies, etc. EASY TO OPERATE. Simplified controls make it virtually impossible to make a mistake. Five "PIANO KEYBOARD" buttons control all functions: Fast forward, Play-back, Stop, Record and Fast reverse. Also has 3 Knobs: Speed Selector, Tone and Off-Volts. Record "Lock" Button prevents accidental erasure. Any tape can be erased if desired and used again and again. Erases automatically while making new recording. Two "Easy-View" neon-type indicators show normal and overload levels. Two-speed Dual track mechanism gives a wide choice of recording time—up to three hours on the new "Scotch" 1800 ft. reels of tape. Richly styled blue and gray leatherette covered case with sloping removable lid. Portable—weighs only 23 lbs. Supplied complete with tubes, crystal microphone and cable, 600 ft. (5 inch) reel tape, 5" take-up reel and removable power cord. Size 14" x 12" x 9 1/2". UL Approved. Operates on 115 Volts 60 cycles AC.

FIRST QUALITY PLASTIC BASE RECORDING TAPE

1200 Ft. Tape on 7" Dia. Reel

STOCK NO. X-249. Lots of 6. **\$1.79** Each
Lots of 12. **\$2.19** EA. Single

Famous Brand—Reg. \$5.50—Now at 71% discount. Free response 50-15,000 cps—1 1/4" wide—fits all recorders. Shpg. wt. (one dozen) 10 lbs.

Espey HI-FI AM-FM RADIO CHASSIS

Complete with 10 Stock No. RA-166

Matched Tubes, Knobs, Escutcheon, Antennas **\$49.95** and Hardware, Only

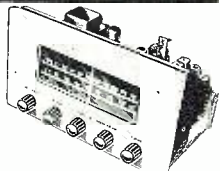

Espey Chassis with 12" Magnavox Speaker—**STOCK NO. AS-117 ONLY \$59.95**

Espey Chassis complete with 12" Co-Axial Speaker—**STOCK NO. AS-118-ONLY \$59.95**

Olson scoops the nation with this tremendous Hi-Fi Bu. Regularly sells for \$147.50, but Olson put cash on the line so you could save money on the one chassis designed for Quality Installations. Every chassis is packed in factory-sealed cartons. 100% Double-Guaranteed by Olson and the Manufacturer. Five of the ten matched tubes are dual-purpose—giving you the equivalent of 15 tube performance. This brilliant 3M-PM radio is equipped with the built-in two-amplifier for 6L6 or any low variable retentance or any standard crystal phono pickup. Features special drift compensator, universal phono input, 3-position equalizer for finest record playback, beam power amplifiers for powerful music and RCA-ized circuitry. Chassis finished in high-lustre and measures 13 1/2" wide, 7 3/4" high and 10" deep. Front panel neutral grey to match any decor. Dual edge lit slide-rule dial, 115 V. AC 60 cy. Full instructions and mounting diagrams included. Shpg. wt. without speaker 25 lbs., with speaker 32 lbs.

12" CO-AXIAL SPEAKER

Stock No. S-168 **\$12.95**

Newly designed 1955 Model—guaranteed to give wider range and better all around performance than any Co-Axial we've ever featured. 12 watts output, 35 to 15,000 cps response ± 6 db - 8 ohm impedance. Crossover—2000 cps. 6.5 ohm. Altered 5 Magnet 3" tweeter reproduces the highest of notes with utmost clarity. Aluminum moisture-proof voice coils for better heat dissipation. Shpg. wt. 6 lbs.

1/4" ELECTRIC DRILL

Limited Quantity—Reg. \$19.95 Made by Famous Manufacturer

Brand New—Factory Sealed Cartons

Never before could Olson make an offer like this. A precision Electric Drill with cast handle and rear box and a spun steel housing. Has a capacity of 3/4" in steel and 1 1/2" in hardest wood. The no-load speed is 1600 RPM and full load speed is 900 RPM. Amature is dynamically and statically balanced for vibrationless operation. Amature is wound with triple formica wire. Gears are hobbed steel. Perfectly balanced pistol grip handle. Trigger switch can be locked down. These are brand new drills and worth much more. Every one is packed in a factory sealed carton with the manufacturer's guarantee. Equipped with heavy duty Bolden cord and rubber plug. Equipped with precision built three-jaw hand type chuck. Shpg. wt. 6 lbs.

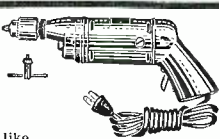

STOCK NO. TL-41 **\$9.95**

With Hand-type Chuck

Drill With Jacobs Chuck. List. \$24.95

Similar to above Drill except with Jacobs gear type chuck and drill is satin finished.

STOCK NO. TL-42 **\$13.22**

HERMETICALLY SEALED VIBRATORS

STOCK NO. VB-52. **69c**

A 6 volt, synchronous, single-reed vibrator—drives only 8 amps. 1 1/2" dia. x 3 3/4" long. Octal Base. Shpg. wt. 1/2 lb. ea. SPECIAL—3 FOR \$2.00

HOW TO ORDER

MAIL OLSON RADIO WAREHOUSE

ORDERS TO 275-J East Market St., Akron 8, Ohio

OLSON BARGAIN STORES TO SERVE YOU IN:

Pittsburgh, Pa. ★ Chicago, Ill. ★ Cleveland, O.
5918 Penn Ave. ★ 623 W. Randolph ★ 2020 Euclid Ave.

Visit the store nearest you

OLSON RADIO WAREHOUSE 275-J EAST MARKET ST., AKRON 8, OHIO

New Year's News from Hallicrafters

CHICAGO 24, ILLINOIS

IN CANADA: BOX 27
TORONTO 17, ONTARIO

Model SX-96 SELECTABLE SIDEBAND RECEIVER

- Covers Broadcast 538-1580 kc plus three S/W 1720 kc—34 Mc.
- Full precision gear drive dial system.
- Double conversion with second oscillator crystal controlled.
- Selectable side band reception of both suppressed carrier and full carrier transmissions.
- Mixer type second detector.
- CW operation with AVC on.
- Delayed AVC.
- Calibrated bandspread—"S" meter—double superhet.
- 10 tubes, 1 rectifier and voltage regulator.



Designed to eliminate co-channel and adjacent-channel interference, the new antenna employs a unique configuration and a new principle of electronic phase cancellation. The antenna has a gain of 16 db and rejects all rear signals and stops venetian blind effects and conflicting signals.

The "Shut-Out" is constructed of aluminum and is pre-assembled for immediate installation.

SILICON TRANSISTORS

Texas Instruments Incorporated, 6000 Lemmon Ave., Dallas 9, Texas has expanded its line of silicon transistors from three to five types.

The two new units include one with an alpha of .975 or better and one with an alpha cut-off frequency of 8 mc. or better. Grown junction silicon transistors operate with little change

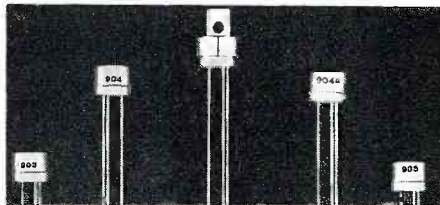

at 150 degrees C compared to an equivalent limit of 65 degrees C for germanium types.

The average alpha cut-off frequency is 3 mc. for three of the types with alpha guaranteed to be from .90 to .95 with Type 903, .95 to .975 with Type 904, and .975 or better with Type 905. Type 904A has an alpha cut-off frequency of 8 mc. or better and an alpha of .95 or better. The Type X-15 large-signal unit gives a power gain of 14 db with collector dissipation of 1 watt in class B operation.

Bulletin DL-S 426 covering these silicon transistors is available from the company on request.

NEW FINCO ANTENNAS

The Finney Company, 4612 St. Clair Ave., Cleveland 3, Ohio is now offering two new antennas that are specifically designed to solve the problems of "in-between" TV reception areas.

The Model 200-A is a two-bay unit custom-built for close-in and semi-fringe areas. The Model 200-SA, another two-bay unit, is constructed for close-in and semi-fringe areas which have a front-to-back ratio problem. This antenna is equipped with a full dimensional screen which eliminates disturbances caused by rear signal interference.

These two antennas are designed to receive all channels, u.h.f. and v.h.f. They are of all-aluminum construction and are designed to withstand ice and wind loads. Both units come pre-assembled.

INDOOR ANTENNA

Marjo Technical Products Co., Linden, N. J. is now offering a new indoor television antenna which has been tradenamed the "Channel King."

Designed to cover the entire TV spectrum, channels 2 through 83, plus

Airex's New Auto-Focus 1955 CHANNELOC 630FA4

Up To 200 Miles Reception • HI Gain
Cascade Tuner • 4 Microvolt Sensitivity

The Perfect Chassis for Fringe Areas
New Exclusive Advancements

- Pictures always in focus • Hi & Low sync. Amplifier • Channel-Locks picture & sound together • Drift free operation • Automatic Freq. Control • Gated A.G.C. • Fringe Area Control • Full 4 Mc. Picture Bandwidth • Photo connection & Switch • Efficient Retrace Blanking • Automatic Brightness Control • Full Focus Cosine Yoke • Fused HV Power Supply • Molded Plastic Condensers • 6CB6 Tubes in Video I.F. • Handles up to 24" Rnd. • Improved Sync System • Auto Former Fly Back • Improved Video amplification • Heavy Duty Power Transformer • Improved Horizontal Sweep • Full range 12" Loudspeaker • 4 Microvolt Sensitivity • Ready for UHF Stations • Size 22"x22"x24".

\$149⁹⁵

Less CR Tube & Brackets
12" Hi-Fi Speaker Tube Mktg. Brackets—\$6.50

Detailed Service Manual & Schematic—\$1.00

Combination Saving

FA-4 Chassis
21" Tube
Mah. Cons.
Cabinet.

\$224⁹⁵

TV Picture Tubes

Standard Brands. Factory New. Guar. 1 year.

- 21" Tube\$34.95
- 24" Tube Rect. \$59.95
- 27" Tube Rect. \$74.95

PLASTIC MASKS

- 20" and 21"\$ 7.95
- 24"\$14.95
- 27"\$17.95

Send for Cabinet & Hi-Fi Parts Catalog

630-9 TV Chassis for 24" & 27" Tube

• Channeloc-Picture & sound locked together • No drift • Reception up to 200 miles • 90 degree deflection • 22 KV high voltage power supply • For 24" & 27" rect. tubes • Photo connection & switch on chassis • Adaptable for color • RMA guarantee.

\$179⁹⁵

With 12" Hi-Fi RCA Speaker

TUBE MTG. BRACKETS \$9.95

RECORD CHANGER SAVINGS

- Webster-Chicago. 1121 type series, with turnover crystal cartridge\$24.95
- Webster-Chicago. 1121 type series with turnover Titone dual sapphire cart. 26.95
- Webster-Chicago. 1121 type series with E. RFX 050 Reluctance cart. 29.95
- VM 951, complete with turnover cart. 24.95
- Garrard. RC 80 with 2 plug-in heads. 41.50
- Garrard. RC 90 with 2 plug-in heads. 59.95
- 45 RPM spindle for Garrard. 3.37
- G.E. RFX050 dual sapphire Reluctance cart. 6.49

All merchandise is brand new, fact. fresh & guar. Mail & phone orders filled on receipt of certified check or MO of 20% of items as a deposit. Balance COD FOB fact. N. Y. Prices & specifications subject to change without notice.

AIREX RADIO CORP.

171 Washington St., N. Y. 7 CO 7-5218

SAVE UP TO 85% ON GOVT SURPLUS!

GOVT SURPLUS E.E.B SIGNAL CORPS FIELD TELEPHONE

A private phone or intercom system. Easy to operate. Use any place that portable, 2-way communication is desired. Gives clear reception up to 15 miles. Operates on two standard batteries. Several phones may be used on the same line. Set contains a ringing generator, leather carrying case and phone. Each set is reconditioned & checked-out.

1495^{EA}

Complete circuit - Set of 2 2950

Pay by Money Order or Check, P.O.'s accepted from D&B firms, 50% deposit with C.O.D.'s. Prices F.O.B. Los Angeles.

WORLD'S MOST AMAZING BARGAIN CATALOG

1954 EDITION—OVER 320 PGS

SAVE UP TO 85% ON WAR SURPLUS

Packed with SENSATIONAL VALUES in WAR SURPLUS, FACTORY CLOSE-OUTS and GENERAL MERCHANDISE!

Fully Illustrated. Packed with thousands of Bargains in Hand & Power Tools, Radio Speakers, Ear Phones, Electronics, Gadgets, Electric Motors & Blowers, all types of Hydraulic Equipment, Outdoor & Sports Equip., Cameras, Precision Instruments, Microscopes, plus many, many more.

Send 50c To cover the cost of Handling and Mailing. CREDITED to your first order.

PALLEY SUPPLY CO. 2263 E. VERNON AVE., DEPT. TV-1
Los Angeles 58, California

the FM band, the antenna can be adjusted to a half-wavelength at any frequency, u.h.f., v.h.f., or FM, by

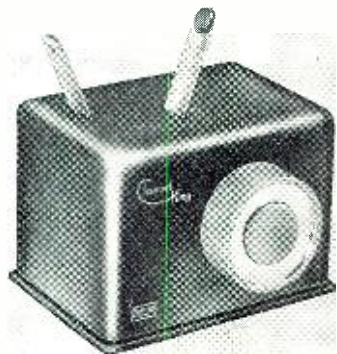

means of a simple, foolproof tuning operation. This tuning is accomplished by means of a knob which lengthens or shortens the antenna arms to provide resonance at any desired frequency.

When not in use, the antenna arms are retracted completely into the case and are invisible. The case measures 3 1/4" high, 4 5/8" deep and comes in either mahogany, ivory, or black plastic.

SMALL CAMERA TUBE

Resitron Laboratories, Inc., 2025 Pontius Ave., Los Angeles 25, California has developed a small camera tube for industrial, military, TV broadcast, and amateur uses, the 6198.

The new tube is said to combine high sensitivity and resolution with long life. Dimensions are approximately 1" face diameter and 6 1/4" high, including pins. The photoconductive spectral response approximates very closely that of the human eye.

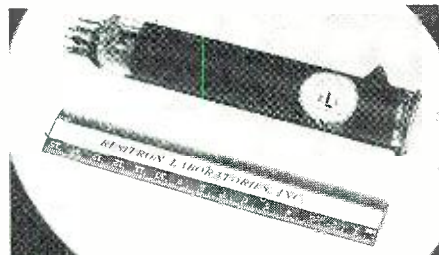

Photoconductive surfaces of different spectral responses are available on request.

The tube design is adaptable to a wide selection of commercially available lenses.

"4-WAY TOOL"

CBS-Hytron of Danvers, Mass. has come up with another time-saving tool by-and-for the service technician.

The newest entry is a "4-Way Tool" designed to solve the problem of having the right tool handy to remove the back covers of TV receivers.

The tool consists of three parts—a slotted steel barrel with hex sockets 1/4 inch at one end and 5/16-inch at the other; a double-ended screwdriver blade, one end with Phillips head and the other with a hollow-ground standard head—all of which slides inside the barrel; and a knurled setscrew to lock the sliding blade into any one of

January, 1955

From NEWCOMB'S Big, NEW HI-FI LINE

The two new Compacts, with amplifier, preamplifier and control unit all in one...the new Classic 200 FM-AM Tuner, the answer to years of demand...just three of the twelve all new components in the Newcomb line—a line which offers an amplifier for every hi-fi need. All twelve reflect the engineering leadership for which Newcomb has been famous since 1937. Visit your dealer... see and hear the full Newcomb line—priced from \$59.50 to \$297.50. You'll understand why Newcomb is your best buy in hi-fi!

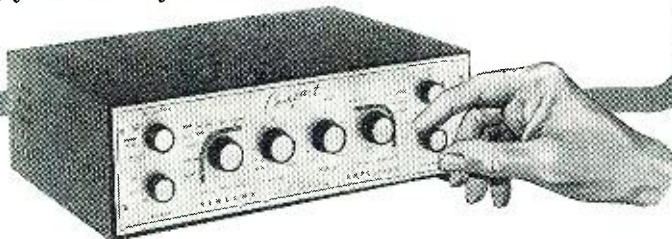

HI-FI COMPLICATED? EXPENSIVE? NOT WITH NEWCOMB'S COMPACT 12!

Newcomb offers every music lover authentic high fidelity with a minimum of expense and trouble in the new Compact 12. Provides unequalled flexibility and range of sound control. Needs no cabinet. Just plug it in, connect it to a record changer and speaker. But if you prefer to use cabinetry, it includes Newcomb's exclusive "Adjusta-Panel" feature for easy installation. Simple to move—ideal for apartments! U/L approved.

Compact 10—A simplified 10-watt version of exceptional performance

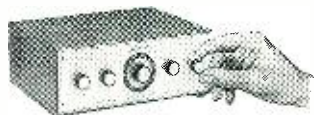

Compact 12 Specifications

12-watt high fidelity amplifier—preamplifier—control unit • less than 1% distortion at 12 watts • response ± 1 db 20 to 20,000 cycles • separate crossover and rolloff controls give 36 different recording curves • input selector and rumble filter • 7 inputs • mike input • tape input • output to tape • wide range separate bass and treble tone controls, bass range —15 db to +18 db, treble range —18 db to +16 db • hum balance control • new level control • advanced design loudness control • size only 4 5/8" high x 12 1/2" x 9"

FOR SUPERIOR RADIO RECEPTION NEW Classic 200—2 knob FM-AM Tuner

For years now, satisfied Newcomb amplifier owners have asked for a tuner by Newcomb. Here it is—the Classic 200 high fidelity tuner to deliver the utmost to a fine amplifier! It, too, is compact in size.

Designed for use with any amplifier having its own controls. Fully enclosed, beautifully finished to use as is, or the exclusive "Adjusta-Panel" makes cabinet installation simple. U/L approved. Output is 10 volts at less than 1/4%. 1 volt at less than 4/100%. Effective to 200 feet from amplifier. Many new circuit advances in both FM and AM sections. Results: 30 db of quieting with only 1 1/2 microvolts input on FM. 1 microvolt AM sensitivity for 1 volt output. Only 6 3/8" high x 11 1/2" x 11 1/2".

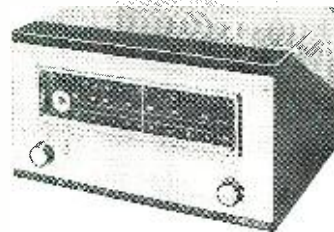

HI-FI GUIDEBOOK

"Hi-Fi Is For Everybody" Explains the how and why of authentic high fidelity • How to buy and install economically • Informative and thoroughly illustrated • Not a catalog



NEWCOMB® SINCE 1937

High Fidelity Amplifiers and Tuners

- Here's 25c for new book, "Hi-Fi Is For Everybody."
- Please send free catalog of Newcomb's complete line of 12 new hi-fi products, plus name of my nearest Newcomb dealer.

NEWCOMB, Dept. F-1
6824 Lexington Ave., Hollywood 38, California

Name _____

Address _____

City _____ Zone _____ State _____

NEW Year's News from Hallicrafters

CHICAGO 24, ILLINOIS

IN CANADA: BOX 27
TORONTO 17, ONTARIO

Model SX-99 RECEIVER

Here is everything you could wish for in a DX receiver. Covers Broadcast Band 540-1680 kc plus three short-wave bands 1680 kc-34 Mc calibrated for the 10, 11, 15, 20, 40 and 80 meter amateur bands over a large easy-to-read dial. Features for the amateur—"S" meter, separate bandspread tuning condenser, crystal filter, antenna trimmer, one r-f, two i-f plus 3.2 and 500 ohm speaker terminals.

Gray-black steel cabinet with brushed chrome trim and piano hinge top, 18 $\frac{1}{2}$ " x 8 $\frac{1}{2}$ " x 11". Shipping weight 36 lbs.

Seven tubes plus rectifier. 105/125 V. 50/60 cycle AC. \$149.95 (less speaker). Use Hallicrafters R-46A Speaker.



three recessed positions within the slotted barrel. When the sliding blade is centered within the barrel, either hex socket can be used. Either screwdriver head may be drawn out of the barrel and located into position for use.

The new tool is being handled by the company's distributors.

SELENIUM RECTIFIER KITS

Bradley Laboratories, Inc., 168 Columbus Ave., New Haven 11, Conn. is now merchandising a series of vacuum processed selenium rectifier kits which is designed to save the time of a development engineer.

The kits contain fully assembled rectifiers marked with commercial coding. The series of seven kits will enable the engineer to have on hand the full range of commercially available selenium rectifiers. The series offers a complete range of sizes from 3/16" diameter plates to 5" x 6" plates, with ratings from 1.5 ma. d.c. up to 3700 volts peak inverse to types rated at 10 amperes and 222 volts.

SLUG-TUNED COIL FORMS

Cambridge Thermionic Corporation, Cambridge, Mass. has announced the availability of a new miniature slug-tuned coil form assembly, the LS-9.

The new assembly is well shielded electrically and is particularly suited for applications that require miniature size, rugged shock-resistant construction, and a mechanically enclosed, protected coil.

The unit measures 7/16" in diameter by 1/2" high, excluding terminals, with a

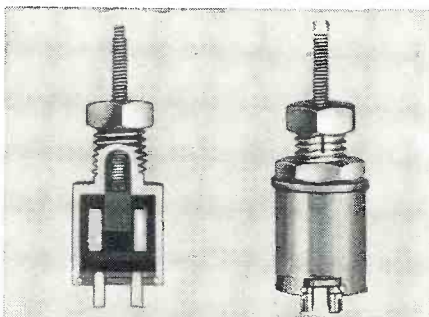

single 1/4-28 threaded mounting stud 13/32" long. The LS-9's can be used as simple r.f. coils, tapped r.f. coils, or r.f. and i.f. transformers.

COLOR-CODED NUT DRIVERS

Xcelite, Incorporated, Dept. RN, Orchard Park, N. Y. is now offering a new nut driver kit, the No. 77.

In neat, snug compartments, the kit contains the seven nut drivers most often needed by the service technician, 3/16" through 3/8", each with a different colored handle to flash the size.

The kit snaps shut to 6 $\frac{1}{4}$ " x 7" for easy carrying and is equally suitable for benchwork or jobs away from the shop.

"POSTAGE STAMP" TOROID

A new "postage stamp" toroid coil, consisting of a subminiature molybdenum permalloy toroid core with a winding having a residual hole as small

as 1/16" is now being produced by *Hycor Company, Inc.*, 11423 Vanowen Street, North Hollywood, California.

The windings are impregnated with a special compound and the finished

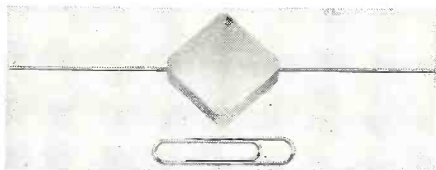

coil is encased in a tough epoxy plastic. Tinned #20 AWG wire leads are provided and the coil may be handled and mounted in the manner of its counterpart, the postage stamp mica capacitor. Dimensions are 13/16" x 13/16" x 3/8" thick. It is available in any inductance up to 1 henry. The useful frequency range covers 1500 cps to 150 kc., depending on the inductance value.

U.H.F. DEMODULATOR

An ultra-high-frequency demodulator for use as an accessory with u.h.f. TV test equipment operating in the frequency range from 300 to 950 mc. has been announced by the Tube Division of *Radio Corporation of America*, Harrison, N. J.

The WG-298A facilitates the measurements of voltage standing-wave ratios of receiver inputs, antennas, and other u.h.f. loads operating from 300-ohm transmission lines.

A plug-in type, with a built-in germanium diode, the demodulator operates between a 50-ohm single-ended source and a balanced 300-ohm transmission line. It is designed for use with the company's WR-86A u.h.f. sweep generator or with comparable generators using a 50-ohm BNC type of output connector.

D.C. BIAS SUPPLY

An accurately-adjustable source of fixed bias between 0 and 17 volts d.c. is provided by the new low-cost, pocket-size Model 703 bias box recently introduced by *Boland & Boyce, Inc.*, 236 Washington Avenue, Belleville 9, N. J.

The new instrument is said to simplify radio and TV alignment by supplying a steady external bias voltage independent of the receiver's a.g.c. circuit. Alligator clips on the bias box allow the unit to be clipped to any convenient part of the chassis apron. In operation, one lead from the bias box is connected to the nearest hot 6.3 volt heater terminal and the other lead connected in place of the receiver's usual a.g.c. supply. A calibrated control on the box adjusts bias voltage to the set manufacturer's recommendations.

ALLIANCE ANTENNAS

Alliance Manufacturing Company, Alliance, Ohio has entered the antenna field with the introduction of its "Monolober" unit.

Available in either single- or double-bay versions, the new unit adds the gain of its v.h.f. antenna to the u.h.f.

**GENERAL ELECTRONIC'S
NEW MODEL 137**

50,000 Ohms Per Volt 62 RANGE—MULTIMETER

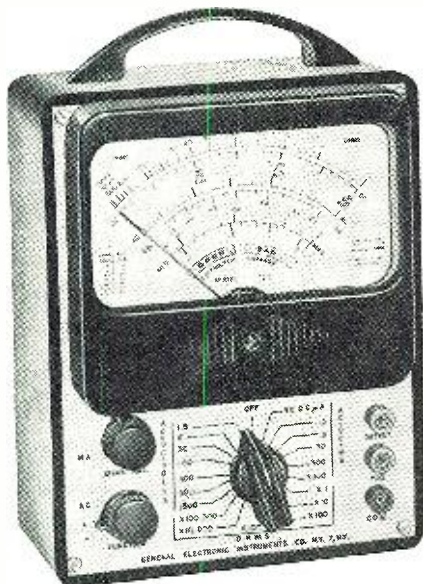

MEASURES—5 1/4" x 6 7/8" x 2 1/4"

SPECIFICATIONS:

- DC VOLTS** (Pos. & Neg.): 0-1.5/6/30/150/300/600/1500
- AC VOLTS:** 0-1.5/6/30/150/300/600/1500
- OUTPUT VOLTS:** 0-1.5/6/30/150/300/600/1500
- RESISTANCE:** 0-2,000/20,000/200,000 Ohms—2/20/200 Megohms
- DC CURRENT** (Pos. & Neg.): 0-30/300 Microamp; 0-3/30/300/3000 Ma
- AC CURRENT:** 0-300 Microamp; 0-3/30/300/3,000 Ma
- CAPACITY:** .001 to .1 MFD—.1 to 50 MFD
- LEAKAGE:** Good-bad scale for checking quality of Electrolytic Condensers
- DECIBELS:** —6 to +18, +14 to +38, +34 to +58

FEATURES:

- 10,000 ohms per volt on AC. Highest AC sensitivity in any Multimeter at any price, to the best of our knowledge.
- Input impedance on 150 Volt scale and up, equal to and better than that of most VTVM'S—No circuit overloading.
- Polarity reversing switch for DC—No time lost in reversing of leads.
- Large rugged 4 1/2" 20 Microamp meter.
- Completely self contained—No external source of power required.
- Lightweight and rugged.

The Model 137 comes housed in an attractive round cornered black bakelite case with a hand engraved gray easy to read panel. Black designations. Factory calibrated. Test leads and operating instructions included.

\$49.50
NET

**General Electronic's
New Model 734**

**RESISTANCE—CAPACITANCE
INDUCTANCE BRIDGE**

The New Model 734 is a true R-C-L Bridge designed for simplicity of operation and at the same time to meet professional standards. Actual inductors are used as standards in this unit. A 110 V 60 cycle transformer is used with an indicating "MAGIC EYE TUBE". There is **no maze** of switches and leads.

SPECIFICATIONS:

- CAPACITY:** 10 MMF to 5,000 MMF
1,000 MMF to .5 MFD
.1 MFD to 50 MFD
- RESISTANCE:** 10 Ohms to 5,000 Ohms
1,000 Ohms to 500,000 Ohms
100,000 Ohms to 50 Megohms
- INDUCTANCE:** 10 Microhenry to 5 Millihenry
1 Millihenry to 500 Millihenry
.1 Henry to 50 Henry

\$28.95
NET

The Model 734 comes housed in a round cornered bakelite cabinet with attractive modern hand engraved gray panel. Complete with test leads and operating instructions.

**General Electronic's
New Model 340**

**AUDIO
OSCILLATOR**

The New Model 340 uses a Cathode follower output stage to reduce load variations. A stabilized voltage is maintained with the use of a Wein Bridge Circuit. The oscillator will produce frequencies from 20 CPS to 20 KC in 3 ranges, with a flat response of ±1 DB on all ranges. The output voltage being relatively constant makes the Model 340 ideal for running frequency response curves in audio circuits.

SPECIFICATIONS:

- 20 cycles to 200 cycles
- 200 cycles to 2,000 cycles
- 2,000 cycles to 20 KC

The New lightweight Model 340 comes complete with test leads and operating instructions. Housed in a round cornered black bakelite box with attractive hand engraved gray panel, it becomes a credit to any serviceman's bench.

\$27.50
NET

MEASURES: 5 1/4" x 6 7/8" x 2 1/4"

**General Electronic's
New Model 940**

**FLYBACK-YOKE-
CRT TESTER**

Provisions for Testing All Types of Inductance and Linearity Coils. Voltage and Resistance Measurements Included

FEATURES:

- Standard ohmmeter scale for accurate measurements of circuit resistances.
- D.C. voltages up to 600 volts can be read directly on scale.
- Detects even 1 shorted turn in a flyback.
- Separate scale for air coils.
- A large 4 1/2" meter is used.
- Will check all magnetically deflected CRT tubes from 7 to 30 inch in the set with the well established emission principle.
- A truly compact unit measuring 5 1/4" x 6 7/8" x 2 1/4"
- Built rugged for field use.

The New lightweight Model 340 comes complete with test leads and operating instructions. Housed in a round cornered black bakelite box with attractive hand engraved gray panel it becomes a credit to any serviceman's bench.

\$33.50
NET



**General Electronic's
New Model 920**

AC VOLTMETER

Sensitivity has been the keynote in the design of the new Model 920. Frequency is practically flat from 10 CPS to 100 KC. With fixed input impedance of 1 Megohm at all ranges. A large face 4 1/2"—100 Microamp meter is used. This unit utilizes 4 crystal diodes in a bridge circuit to assure maximum scale linearity. Can be used as a better voltage indicator than most scopes for measurements as a bridge detector, null indicator and for compilation of frequency response data.

SPECIFICATIONS:

- RMS VOLTAGES:** 0-.01, .03, .1, .3, 1.0, 3.0, 10, 30, 100, 300, 1,000
- PEAK TO PEAK:** 0-.028, .0849, .283, .849, 2.83, 8.49, 28.3, 84.9, 283.0, 849, 2830.
- DECIBELS:** —10, —20, —30, —40, —50, +10, +20, +30, +40, +50, +60 DB

The Model 920 comes housed in an attractive round cornered black bakelite case with a hand engraved gray easy to read panel. Black designations. Factory calibrated. Test leads and operating instructions included.

\$29.95
NET

MEASURES: 5 1/4" x 6 7/8" x 2 1/4"

Guarantee

All of our units are sold on a money-back-if-not-satisfied basis. If, after trying these units for 15 days at your convenience, you are not completely satisfied, return the testers for full immediate refund, without any obligation on your part. A 10% deposit is required on all C.O.D. orders.

GENERAL ELECTRONIC DISTRIBUTING COMPANY

98 Park Place, Dept. RN-1,
New York 7, N. Y.

Please send the units checked below. If I am not fully satisfied within 15 days, I may return them for immediate refund.

- MODEL 137 MODEL 340 MODEL 920
- MODEL 734 MODEL 940 Free Catalog

Enclosed \$..... Send C.O.D. Deposit \$.....

NAME

ADDRESS

CITY..... ZONE..... STATE.....

1955 ELECTRONICS PREMIERE

1st Annual
Industrial - Amateur

ELECTRONICS SHOW

- ★ Door Prizes!
- ★ Free Drawings for Valuable Equipment!
- ★ Free Refreshments!

Sunday,
January 23rd
1 P.M. - 9 P.M.

Grand Ballroom
Park Sheraton Hotel
56th St. and 7th Ave.,
New York City

Over 100 exhibits by the country's
leading electronics manufacturers.

Be the first to see what's
NEW for 1955!
Admission free.
No ticket
necessary.

Sponsored
by

ARROW ELECTRONICS INC.

65 Cortlandt St., N. Y. C.
DI 9-4714

The antenna comes pre-assembled with snap-out design for fast, easy installation. High directivity is assured with a "monolobe" pattern.

Constructed of aluminum with rust-resistant or plated hardware, the u.h.f. portion and the v.h.f. reflectors are secured to the boom and need only to be unfolded and the wing nuts tightened to be in operating condition. The antenna is weatherized and requires no tying or special securing of elements in windy areas.

NEW TV TESTER

Seco Manufacturing Co., 5015 Penn Avenue South, Minneapolis, Minnesota is now offering a simple flyback interval and inductance checker to the service trade.

By merely connecting two test leads from the instrument, it is possible to tell at a glance on the eye indicator



if the coil components are OK. No disconnection of parts is necessary. The FB-4 quickly checks flyback intervals to reveal horizontal circuit troubles. It also reveals the condition of coil components as a connected group, namely from the standpoint of the self-resonant frequency established with the distributed capacity in the coils and circuits.

LINEARITY GENERATOR

A new test instrument designed to produce white dot and bar patterns for use with color or monochrome television receivers has been announced by

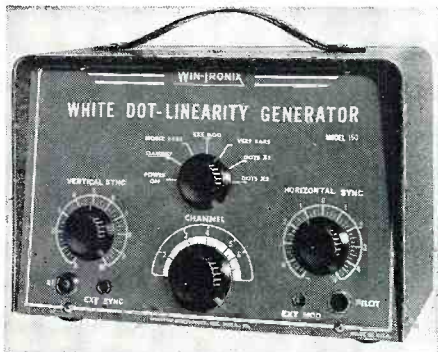

Winston Electronics, Inc. of 4312 Main Street, Philadelphia 27, Pa.

Known as the Model 160 white-dot linearity generator, the instrument provides both large and small white dots for ease of tri-color kinescope receiver convergence adjustments plus

RADIO & TELEVISION NEWS

NEW! EICO FLYBACK & YOKE TESTER KIT



MODEL
944

Checks all flybacks & yokes
instantly—in or out of set!

- Detects even 1 shorted turn!
- Exclusive separate calibration for air & iron-core flybacks for accurate testing of all types.
- Tests continuity of coils, speakers, switches, etc.
- Large 4½" meter, 3 colored scales.
- Complete with easy instructions.
- Compact, rugged, smartly styled.

See it at your jobber today. Write for FREE Catalog RF-1 describing EICO's 36 Kits and 42 Wired Instruments. Prices 5% higher on West Coast.

EICO ELECTRONIC INSTRUMENT CO., Inc.
34 Withers Street, Brooklyn, N. Y.

© 54

New York's Radio Exchange

AT PRICES AS NEVER BEFORE
WHOLESALE AND EXPORT ONLY
STANDARD BRANDS FIRST QUALITY

FULLY GUARANTEED
JAN and NON-JAN

5000	1A7GT	Each	15000	6J5GT	Each
10000	1C6	.49	10000	6G6G	.38
3000	1D86T	.60	5000	6K6GT	.48
2000	1H5GT	.39	5000	6K7G	.25
1000	1LA6	.45	5000	6L7G	.35
2000	1N22	.45	1000	6N7G	.60
5000	1N4YA	.55	5000	6S7G	.35
5000	1S4	.38	2000	6X5GT	.50
1000	2A7	.25	2000	6S67	.45
10000	3B7	.35	2000	6S17	.45
3000	3D6	.35	3000	6SK7	.42
6000	6AB7	.50	2000	6SK7GT	.45
6000	6AC7	.69	8000	6SH7	.45
3000	6AG5	.45	1000	6U5	.55
2000	6AK5	.70	5000	6X5GT	.38
5000	6B7	.70	5000	6Y7G	.24
5000	6BA6	.42	1000	7C5	.57
2000	6BE6	.42	1000	7C7	.57
5000	6B8G	.29	2000	7Z4	.49
5000	6C8G	.42	1000	12J5GT	.38
5000	6C6	.38	1000	12K8	.43
5000	6D6	.45	5000	12SC7	.46
2000	6E5	.50	15000	12SK7	.46
5000	6F5	.27	5000	12SR7	.46
5000	6F7	.35	1000	12SJ7	.42
5000	6F86	.38	1000	12Z3	.19
5000	6C6	.38	2000	19	.19
5000	6H6	.33	5000	78	.49
5000	6H6GT	.27	10000	89	.06
10000	6J5	.39			

IN WHOLESALE QUANTITY ONLY
HUNDREDS OF OTHER TYPES

Receiving, Transmitting, Radar, Kly-
stons, Magnetrons, also Micro-Wave
Test Equipment

MINIMUM ORDER OF EACH TYPE, 100



This month's special: 5000V.
power supply for 1225 infra red
image converter, \$9.90 each.

LIBERTY ELECTRONICS, INC.

135 LIBERTY STREET NEW YORK 6, N. Y.
PHONE WORTH 4-8262

CABLES: TELSERUP

For Exclusive Information: New Developments on the AIR-COUPLER AND THE VAN-AMP

The New
Air-Coupler Series in
Be Sure to Read

"At the New York and Chicago shows last fall, more than 240 audio enthusiasts came to the MUSIC at HOME Magazine exhibits to tell me of the remarkable results they had obtained from Air-Coupler systems, or from adding on Air-Coupler to their other speakers to reinforce bass reproduction. Most enthusiastic of all were those who must, for one reason or another, operate their equipment on moderate or low volume level, at which full bass reproduction is most difficult to obtain."—Milton B. Sleeper

Now, as a part of its series of articles on the construction, installation, and operation of the Air-Coupler, MUSIC at HOME presents the details of the VAN-AMP, which advances the art of high-quality reproduction another step toward perfection. The VAN-AMP performs three distinct functions:

1. Replacing conventional fixed networks, it permits the crossover frequency to be varied continuously from 90 to 1,100 cycles, or from 900 to 11,000 cycles. With the VAN-AMP you can select the exact crossover for optimum tone. This assumes precise balance of bass, middle, and treble ranges with any combination of speakers according to the acoustics of your home, after you have completed your installation. This eliminates guesswork.

2. The VAN-AMP provides added power, by giving a voltage gain of approximately 6 over the output of your preamplifier. Or you get the same performance with your preamp set at reduced output. More important, however, is the fact that the VAN-AMP eliminates the power loss introduced by the use of a fixed network. This gives you increased reserve output power.

3. The VAN-AMP has a low-impedance output, essential when long leads are required, to prevent attenuation of the high frequencies. This affords greater flexibility.

You will like the compact design and appearance of the VAN-AMP. It is contained in a small, flat case, matching the new preamps and amplifiers. Rigorous laboratory tests show that it does not introduce distortion, even at the high-frequency end. Complete details are given in the January-February issue of MUSIC at HOME.

AIR-COUPLER SERIES: Construction details of the latest Dual Air-Coupler, with dimension drawings, were published in the September-October issue. Network data for 2 and 3-speaker systems and various speaker impedance values appeared in the November-December issue, with details of the VAN-AMP in January-February. March-April will show many different ways to install the Air-Coupler, including special furniture pieces in which it can be built and hidden. (The Special Offers below explain how you can get the back copies and future issues.)

MUSIC at HOME is a complete guide and reference source for everyone interested in fine music, and equipment for records, tape and FM. It is a magazine of practical information for beginners as well as audio enthusiasts who are seeking the finest reproduction quality. Every article is written by a specialist in his particular field. That's why MUSIC at HOME has so quickly become the leading hi-fi magazine in the United States.

Here is a Money-Saving Opportunity for You If You Act Now!

You'll be proud to have this beautiful, large-size magazine in your home. It is elaborately illustrated with dozens of exclusive photographs and show-you-how drawings, handsomely printed on fine paper. Your copies will constitute a valuable reference library of practical ideas and essential information.

SPECIAL OFFER No. 1: While copies are available, we will enter a 1-year subscription for you (6 issues) starting with September-October 1954, so that you will have the new series on the Air-Coupler and speaker networks RIGHT FROM THE START. As a bonus, you will receive WITHOUT CHARGE the issue containing "Origin of the Air-Coupler", the most extraordinary article you have ever read about an invention no one ever saw! (Save 50¢)

SPECIAL OFFER No. 2: While copies are available, we will enter a 3-year subscription for you (18 issues) starting with January-February 1955. In addition, you will receive WITHOUT CHARGE the September-October and November-December issues, containing the first of the series on the Air-Coupler and speaker networks, PLUS the issue containing the article "Origin of the Air-Coupler". (Save \$4.50).



Published by Milton B. Sleeper

Milton B. Sleeper, Publisher
MUSIC at HOME MAGAZINE
207-G East 37th St., New York 16, N. Y.

Enclosed is my remittance for

- \$3.00 for Special Offer No. 1, including a full year's subscription
 \$6.00 for Special Offer No. 2, including a three-year subscription

Name _____

Address _____

Add \$1.00 per year for foreign postage

NEW! All Channel
SUPER POWERFUL VHF-UHF TV RECEPTION
IN ALL DIRECTIONS

Only **\$23.50**

Model AX-524
**ROCKET DIRECTRONIC
MOTORLESS TV ANTENNA
360° ELECTRONICALLY
SWITCHED BEAM**

In the fringe or ultra fringe, the NEW 1955 Motorless Directronic will outperform any ordinary antennas. This sensational new 360° UHF-VHF TV antenna offers "around the compass" reception WITH-OUT Rotors. Provides superb ghost-free picture clarity. Model AX-524 "Serviceman's Array" contains Hi-Pac Molded Insulator of Extreme tensile strength, 2 hi-tensile aluminum elements, including 6 Multi-purpose Reflector-directors, 1 set matched tie rods, Universal Mast Clamps, 6-position Beam Selector Switch, 75' Low-loss UHF-VHF Tubular TR-X Cable.

Our **Greatest BARGAIN**

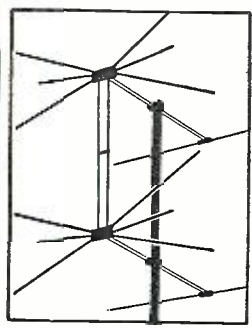

**2-BAY
16-ELEMENT
CONICAL ARRAY
With Hi-Band
Adapters**
Sturdy 3/8" Elements

\$4.99 EACH
IN LOTS
OF THREE
SINGLE LOTS \$5.30

type aluminum elements, including hi-band adapters for greater gain on the high channels and is complete with one pair of stacking bars to each array. These are packed in cartons of three 16-element arrays per carton, with tie rods, at \$14.95 per carton. When purchased in single 16-element arrays, separately boxed—your cost is..... \$5.30 each 3 Two-Bay Arrays per carton without Tie Rods..... \$13.50 carton 4 Bay Ultra-Fringe Stacking Assembly for Above—Model 48..... \$1.95 set

**Super UHF RECEPTION
HI-GAIN
YAGI**



Provides guaranteed sensational UHF fringe reception. Amazing sensitivity provides up to 30 db gain, using 2, 4, or 6 bay stacked arrays. Ghosts, interference minimized or eliminated. Each serviceman's array provides 4 directors, 2 folded dipoles, 2 reflectors. And our low price insures a low cost installation. Select the model required in your area.

\$195
Ea.

Model Covering
F-7A Channels 14-48
F-7B Channels 27-62
F-7C Channels 47-83
Matched stacking bars \$0.30 pr.

100 ft. UHF Tubular Lo-Loss Lead..... \$4.95
PAT-9 Chimney Mount with Strapping..... 1.49
TWA Lightning Arrestor..... .69
BO Barkhausen Eliminator..... .69

UHF CORNER REFLECTOR



**ONLY 2.99 EACH IN
LOTS OF 6**
SINGLE LOTS \$3.50 EACH

This hi-gain UHF Corner Reflector can only be offered you at this low price for a short time, 8 to 11 db gain across UHF band. Order Model P-6.



**NEW LOW PRICE!
RADIART TELERTOR**

Radiart's famous TR-2 at new money-saving price. Powerful, rugged, weather-proof — handles installations up to 150 lbs. Control box light indicates orientation of antenna. Factory lubricated for life. Truly a good buy at our new price. Uses 8-cond. wire. 8-cond. wire... \$0.08 ft.

\$26.97

MODEL TR-2

**National Electronics
OF CLEVELAND
THE HOUSE OF TV VALUES**
6608 Euclid Ave., Dept. N-1, Cleveland 3, O.

**Editors and Engineers
PUBLICATIONS**

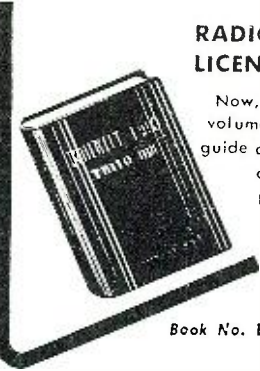

**RADIOTELEPHONE
LICENSE MANUAL**

Now, in one convenient volume, complete study-guide questions with clear, concise answers for preparation for all U.S.A. commercial radio-telephone operator's license examinations

Book No. E&E-RL1

\$3.75*

WORLD'S EQUIVALENT TUBES (Equivalent's Vade Mecum) NEW 10TH EDITION A guide for substitutions of radio tubes, indicating direct or near equivalents.
Book No. E&E-VM10..... \$5.00*

WORLD'S RADIO TUBES (Brans' Vade Mecum) 9TH EDITION. Lists over 15,000 tubes from every tube making country. Printed in 16 languages.
Book No. E&E-VM9..... \$5.00*

ANTENNA MANUAL. A practical, comprehensive book on antennas, for everyone interested in transmission and reception. Over 300 pages.
Book No. E&E-AM1..... \$3.50*

SURPLUS RADIO CONVERSION MANUAL VOL. 1. Practical conversions. Write for list of contents. Book No. E&E-SM1..... \$2.50*

SURPLUS RADIO CONVERSION MANUAL VOL. 2. Companion to Volume 1.
Book No. E&E-SM2..... \$2.50*

*Plus any tax.

BUY FROM YOUR DISTRIBUTOR
ADD 10% ON DIRECT MAIL ORDERS TO
EDITORS AND ENGINEERS, Ltd.
BOX 689A, SANTA BARBARA, CALIF.
Specialize order from BAKER & TAYLOR, HILLSIDE, N. J.

CAMERA OWNERS!

10c

**brings you a digest of
SUCCESSFUL COLOR PHOTOGRAPHY**

the new \$4.95 book by
Andreas Feininger

Here is the authoritative, yet easy-to-follow work on color photography you've been waiting for. Written by Andreas Feininger—one of the world's foremost photographers—it's the simplest, yet most complete discussion of color photography ever to appear.

This book digest from the pages of Popular PHOTOGRAPHY Magazine is going to save you time, money and temper... and improve your pictures in the bargain. And—while supply lasts—it's yours for only 10c.

But don't delay. Fill out the coupon below and mail it today!

**POPULAR PHOTOGRAPHY, Box RTV
366 Madison Avenue
New York 17, New York**

Here's my 10c. Please send me a copy of **SUCCESSFUL COLOR PHOTOGRAPHY**, a digest of the \$4.95 book by Andreas Feininger.

Name.....
Address.....
City..... Zone..... State.....

vertical and horizontal bars for sweep circuit alignment. Internally generated vertical sync pulses, locked to line frequency, insure stable operation.

Additional features are r.f. carrier outputs and external modulation provisions. Further information on this instrument is available from the company on request.

TRANSISTOR COMPONENTS

Electrical Industries, 44 Summer Avenue, Newark 4, New Jersey has introduced a new series of standard components for transistors and other assemblies requiring hermetic sealing.

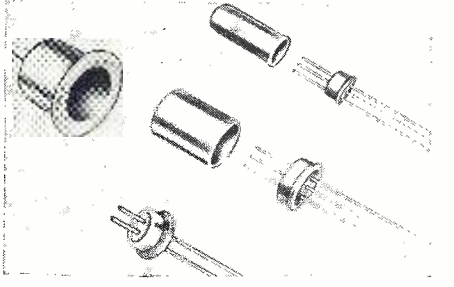

The new miniature components are available in standard types with three, two, or single wires. All outside leads are approximately 1 1/4" in length. Both Kovar and compression types are included in the line and shapes include square, round, and rectangular.

The company will supply literature and samples upon request.

"SUPER POWER" TRANSISTOR

Minneapolis - Honeywell Regulator Company, Wayne & Widrim Aves., Philadelphia 44, Pa. has developed a "super power" transistor capable of delivering up to 5 amps of electrical current to a motor.

The new germanium unit has approximately five times greater capac-

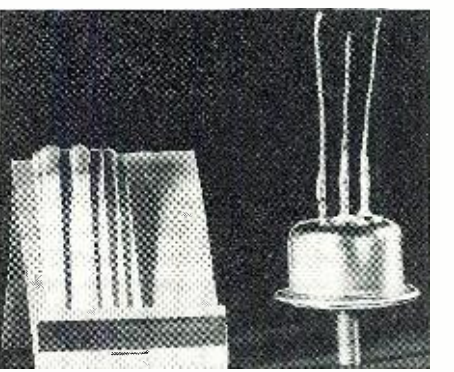

ity than the company's present production models. The power handling capabilities of the new unit are made possible by a unique structure which permits rapid flow of heat to the outside of the unit, from which it can be conducted by a wide variety of means, depending on the application.

Current gain is approximately 30, even at collector currents up to 1 amp. The transistor can operate with a maximum collector voltage up to 30 volts in a common emitter circuit or up to 60 volts in a common base circuit. It is designed for a variety of ap-

lications, including the operation of electric motors and the output sections of high-power audio systems.

COMMUNICATIONS RECEIVERS

The Hallicrafters Company, 4401 West 5th Avenue, Chicago 24, Illinois has added three new models to its line of communications equipment.

The new units are the FM civic patrol receiver, model S-94 and S-95; a new short-wave receiver, the S-85 and S-86; and a second short-wave receiver, the Model S-38D.

The Models S-94 and S-95 retail in the moderate price class with the former covering 30 to 50 mc. and the latter from 152-173 mc. They are designed to cover police, fire, taxicab, bus, railroad, private telephone mobile, and other industrial and emergency communications.

The S-85 is for a.c. and the S-86 for a.c.-d.c. operation, covers the standard broadcast band and three short-wave bands from 1680 kc. to 34 mc. It has the 10, 11, 15, 20, 40, and 80 meter bands calibrated bandsread for better selectivity on ham bands.

The Model S-38D replaces the older Model S-38C and is designed for the s.w. listener or new radio amateur.

PORTABLE COLOR BAR UNIT

The Hickok Electrical Instrument Co., 10534 DuPont Avenue, Cleveland 8, Ohio has introduced a portable TV color bar generator which is in the technician's price range.

Known as the Model 655XC, the instrument produces a NTSC standard, 100% fully saturated color bar pattern on the picture tube of any color-TV receiver. The signal generated by this equipment is identical to the signal transmitted over the air. It creates color bars on the TV screen in the following order from left to right: green, yellow, red, magenta, white, cyan, blue, and black.

A Star Is Born...

Only EICO #232 Peak-to-Peak VTVM has all these Advanced Features *

★ FOR THE FIRST TIME ALL CALIBRATION IS DONE WITH INSTRUMENT IN CABINET.

★ 7 non-skip ranges on every function — DC/RMS sine volts: 0-1.5, 5, 15, 50, 150, 500, 1500. (To 30 kv with HYP probe.) Res.: 0.2 ohms to 1000 mega.—Uniform 3 to 1 scale ratio assures extreme wide-range accuracy.

★ Flat freq. response 30 cps to 3 mc.

★ Measures directly peak-to-peak voltage of complex & sine waves: 0-4, 14, 42, 140, 420, 1400, 4200. Vital for TV servicing. Saves the cost of separate Peak-to-Peak Probe.

★ Modern styling, etched panel; compact, easily portable. Size: 8 1/2" x 5" x 5".

★ Terrific time and resolution—One probe for all functions—in a "twist of the wrist" it selects DC or AC (Peak-to-Peak & RMS) OHMS.

★ No annoying lead tangle, no back-and-forth prod changing. Positive action, super-rugged!



NEW PEAK-TO-PEAK VTVM AT LOWEST COST

With Exclusive **Uni-Probe**

KIT \$29.95 **Factory Wired \$49.95**

Complete with UNI-PROBE at no extra cost

Excellent for your bench
Model 249 Peak-to-Peak VTVM with Giant 7 1/2" Meter
KIT \$39.95 **Wired \$59.95**
Complete with UNI-PROBE

See this amazing engineering achievement at your jobber today. Write now for FREE latest catalog RV-1



ELECTRONIC INSTRUMENT CO. INC.
84 Withers Street
Brooklyn 11, N. Y.

Price 2% higher in West Coast. © 34

BUILD 5 RADIOS AT HOME ONLY \$19.95 Complete

With the New Improved 1955 Progressive Radio "EDU-KIT"

NOW INCLUDES High Fidelity, Signal Tracer, Code Oscillator



- ATTRACTIVELY GIFT PACKED
- FREE SOLDERING IRON
- NO ADDITIONAL PARTS NEEDED
- EXCELLENT BACKGROUND FOR TV
- 10 DAY MONEY-BACK GUARANTEE
- SCHOOL INQUIRIES INVITED
- ABSOLUTELY NO KNOWLEDGE OF RADIO NECESSARY

WHAT THE PROGRESSIVE RADIO "EDU-KIT" OFFERS YOU

The Progressive Radio "Edu-Kit" offers you a home study course at a rock bottom price. Our Kit is designed to train Radio Technicians, with the basic facts of Radio Theory and Construction Practice expressed simply and clearly. You will gain a knowledge of basic Radio Principles involved in Radio Reception, Radio Transmission and Audio Amplification.

You will learn how to identify Radio Symbols and Diagrams; how to build radios, using regular radio circuit schematics; how to mount various radio parts; how to wire and solder in a professional manner. You will learn how to operate Receivers, Transmitters, and Audio Amplifiers. You will learn how to service and trouble-shoot radios. You will learn code. You will receive training for F.C.C. license.

In brief, you will receive a practical basic education in Radio, worth many times the small price you pay.

THE KIT FOR EVERYONE

The Progressive Radio "Edu-Kit" was specifically prepared for any person who has a desire to learn Radio. The Kit has been used successfully by young and old in all parts of the world. It is not necessary that you have even the slightest background in science or radio.

The Progressive Radio "Edu-Kit" is used by many Radio Schools and Clubs in this country and abroad. It is used for training and rehabilitation of Armed Forces Personnel and Veterans throughout the world.

The Progressive Radio "Edu-Kit" requires no instructor. All instructions and diagram. All parts are individually boxed, and identified by name, photograph and diagram. Every step involved in building these sets is carefully explained. You cannot make a mistake.

PROGRESSIVE TEACHING METHOD

The Progressive Radio "Edu-Kit" comes complete with instructions. These instructions are arranged in a clear, simple and progressive manner. The theory of Radio Transmission, Radio Reception, Audio Amplification and servicing by Signal Tracing is clearly explained. Every part is identified by photograph and diagram. You will learn the function and theory of every part used.

The Progressive Radio "Edu-Kit" uses the principle of "Learn by Doing." Therefore you will build radios, perform jobs, and conduct experiments to illustrate the principles which you learn. These radios are designed in a modern manner, according to the best principles of present-day educational practice. You begin by building a simple radio. The next set that you build is slightly more advanced. Gradually, in a progressive manner, you will find yourself constructing still more advanced multi-tube radio sets, and doing work like a professional Radio Technician. Altogether you will build fifteen radios, including Receivers, Transmitters, Amplifiers, Code Oscillator and Signal Tracer. These sets operate on 105-125 V. AC/DC. An Adaptor for 210-250 V. AC/DC operation is available.

THE PROGRESSIVE RADIO "EDU-KIT" IS COMPLETE

You will receive every part necessary to build 15 different radio sets. Our kits contain tubes, tube sockets, chassis, variator condensers, electrolytic condensers, mica condensers, paper condensers, resistors, line cords, selenium rectifiers, tie strips, coils, hardware, tubing, etc.

Every part that you need is included. These parts are individually packaged, so that you can easily identify every item. A soldering iron is included, as well as an Electrical and Radio Tester. Complete, easy-to-follow instructions are provided. All parts are guaranteed, brand new, carefully selected and matched.

In addition, the "Edu-Kit" now contains lessons for servicing with the Progressive Signal Tracer, F.C.C. instructions, quizzes, High Fidelity instructions. The "Edu-Kit" is a complete radio course, down to the smallest detail.

TROUBLE-SHOOTING LESSONS

Trouble-shooting and servicing are included. You will be taught to recognize and repair troubles. You will build and learn to operate a professional Signal Tracer. You receive an Electrical and Radio Tester, and learn to use it for radio repairs. While you are learning in this practical way, you will be able to do far more than a repair job for your neighbors and friends, and charge fees which will help you quickly and easily, and have others pay for it. Our Consultation Service will help you with any technical problems which you may have.

FREE EXTRAS

- ELECTRICAL & RADIO TESTER
- ELECTRIC SOLDERING IRON
- TV BOOK
- RADIO TROUBLE-SHOOTING GUIDE
- CONSULTATION SERVICE
- QUIZZES
- F.C.C. TRAINING

Progressive "Edu-Kits" Inc., 497 Union Ave., Dept. RN-37, Brooklyn 11, N. Y.

MAIL TODAY—Order shipped same day received.
10-Day Money-Back Guarantee. Include ALL FREE EXTRAS

Send "Edu-Kit" Postpaid. I enclose full payment of \$19.95 (U.S.A. only).

Send "Edu-Kit" Postpaid. I enclose full payment of \$20.95 (Outside U.S.A.).

210-250 V. Adapter for "Edu-Kit"—\$2.50.

Send "Edu-Kit" C.O.D. I will pay \$19.95 plus postage (U.S.A. only).

I wish additional information describing "Edu-Kit". No Obligation.

Send me FREE Radio-TV Servicing Literature. No Obligation.

Name

Address

PROGRESSIVE "EDU-KITS" INC.

497 UNION AVE., Dept. RN-37, Brooklyn 11, N. Y.

January, 1955

131

www.americanradiohistory.com

Build Your Own Interior - Styled Cabinets

KITS

by **Cabinart**

presenting the

paul klipsch-designed REBEL IV . . .



Now you can build your own Klipsch Corner Horn Enclosure and save money — identical in acoustic design to assembled units and easily put together with a minimum of tools. Priced for the home-builder in unfinished birch.

\$36.00* Net for 12" model
\$42.00* Net for 15" model

BASS REFLEX and EQUIPMENT CABINETS

Ideal housing for hi-fi components. Removable panels make future changes easier. Loudspeaker cabinet acoustically designed for either 12" or 15" speaker.

Overall dimensions:
33 1/2" x 23"
16" Tuner
Compartment:
20" H., 21 3/4"
W. (inside dimensions),
15 1/4" Deep.
Baffle volume:
5 cubic feet.

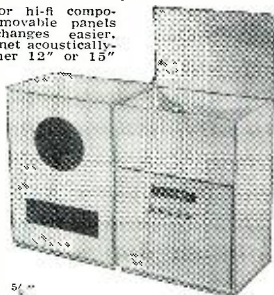

All kits include 5/8" white pine plywood cut to size, baffle pre-cut for 12" or 15" speaker, Saran Plastic Acousti-cloth, Kim-sul Acoustic Insulation, Assembly and finishing instructions, hardware, plastic wood, sandpaper and glue.

No. 80 . . . \$27.00*
(Equipment Kit)

No. 8112 . \$18.00*
(12" speaker)

No. 8115 . \$18.00*
(15" speaker)

CORNER FOLDED HORN ENCLOSURES

Reproduces a quality of bass heretofore only possible through the use of far more expensive designs.

No. 61 (12" speaker) . . \$19.95*
No. 63 (15" speaker) . . \$23.95*

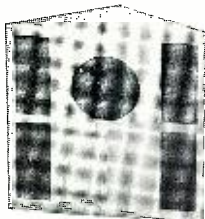

* Prices higher West and South.
Write for free catalog and nearest distributor
Pioneers in radio furniture for high fidelity equipment

G & H WOOD PRODUCTS COMPANY
75 NORTH 11th STREET
BROOKLYN 11, N. Y.

Output of the equipment is either r.f. or video. Video output is 0-2 volts, peak-to-peak open circuit; 0-1 volt, peak-to-peak across 100 ohms, either positive or negative output. The r.f. output modulated with color bar pattern is available through channels 4, 5, and 6. A sound carrier is also provided for accurate setting of local oscillator in TV receiver.

PORTABLE R-C BRIDGE

Deltron, Inc., 2905 N. Leithgow Street, Philadelphia, Pa. has introduced a new, low-cost, completely self-contained, portable resistance-capacitance bridge that measures capacitors from 10 μ fd. to 50 μ fd. and resistors

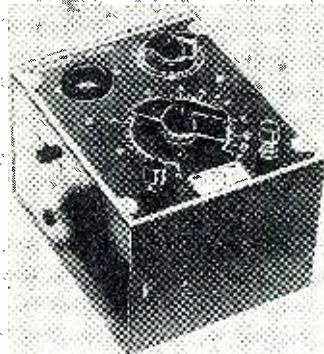

from 10 ohms to 50 megohms. It can also be used for making continuity measurements on circuits, coils, etc.

The bridge is constructed with 1% precision resistors and 2% precision capacitors. The unit detects paper, mica, electrolytic, and air capacitor faults including open and short circuits, high and low capacity, and high power factor.

DECADE RESISTORS

Cornell-Dubilier Electric Corporation, South Plainfield, N. J. is now offering a series of three decade resistors for a wide variety of electrical and electronic applications.

Each unit has two direct-reading panel switch scales in series, permitting 110 different resistance values. The decade resistors may be used individually or may be connected in series to provide a range of values from 1 ohm to more than 1 megohm in steps of one ohm.

Three models are presently available; the RDA with a resistance range of 1 to 110 ohms in steps of one ohm; the RDB with a resistance range of 100 to 11,000 ohm in steps of 100 ohms; and the RDC with a resistance range of 10,000 to 1,010,000 ohms in steps of 10,000 ohms.

Bulletin RD is available from the company's distributors or from C-D.

NEW SUPEREX COMPONENTS

Superelex Electronics Corp., 23 Ather-ton Street, Yonkers, N. Y. has introduced two new components.

The firm has announced the addition of two units to its "Vari-Choke" line, the V-80 with an inductance range of .25 to .5 henry and the V-70 in the range from 100 mhy. to 260 mhy.

These additions now increase the line to a total of seven "Vari-Chokes" covering the ranges of 40 μ hy. to .5 henry inclusive.

The second product is a high-pass interference eliminator combined with a 2-set coupler as the "Filita-Coupler." The unit provides for two-set operation from one antenna and eliminates outside interference from both sets.

Information on either of these new items is available from the firm.

3-WATT WIREWOUNDS

A new subminiature 3-watt wire-wound resistor which is the same size as conventional 1/2 watt molded carbon resistors is now available from the *Sprague Electric Co.*, 237 Marshall Street, North Adams, Mass.

Developed especially for use in military and industrial electronic equipment, this tiny unit, hardly bigger than a match head, is expected to find wide application in point-to-point and terminal board wiring as well as on printed wiring boards. The unit is only 13/64" in diameter by 17/32" in length and has a maximum resistance value of 10,000 ohms.

A complete description of this new resistor is given in the company's Bulletin 111-B, available on request.

PRINTED CIRCUIT COUPLER

Javez, P. O. Box 646, Redlands, California has just released its new TV antenna coupler to the trade.

The new unit is 1" wide by 2" long and 1/4" high and is said to be the only midget coupler on the market featuring printed circuitry. Molded of polystyrene, it features solderless construction and comes complete with screws for mounting anywhere.

"PATTERNTEST"

Hy-Lite Antennae Inc., 242 E. 137th Street, New York 51, N. Y. has developed a unique TV servicing aid which has been tradenamed the "Pattern-test."

The unit simplifies the adjustment of the test pattern on any TV set. It provides control settings for correct definition in line resolution and bandwidth. The "Pattern-test" is affixed to

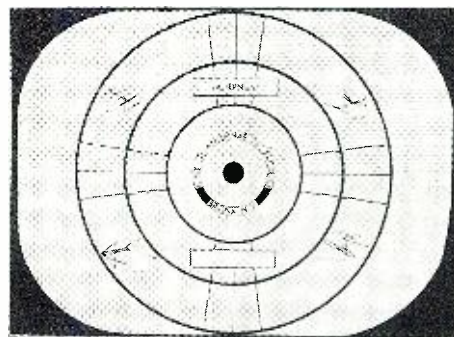

the screen of the TV set with patented pressure-sensitive tape. The service technician then compares the transmitted test pattern with the superimposed "Pattern-test."

For complete information on this light, easily-carried test pattern device, write the company direct. -30-

Spot Radio News
(Continued from page 18)

circuit, driving the grid voltage far beyond the plate-current cut-off value. With the plate current thus cut off, almost as soon as it has started, the grid capacitor discharges through the grid resistor until the grid voltage has recovered sufficiently to again permit a plate-current pulse to flow. The circuit keeps oscillating in this fashion, at a frequency determined largely by the time constant (product of resistance and capacitance) of the grid circuit. Blocking oscillators can be readily synchronized at submultiples of stable signals inserted in their grid circuits; as the grid recovers after being blocked, the tube will fire at or near a positive peak of the synchronizing voltage.

In the crystal-controlled blocking oscillator used in the new system, the required sync signal is obtained simply by coupling a quartz crystal to an ordinary blocking oscillator, by means of a third transformer winding. Alternatively, the crystal can be connected across either the grid or plate winding of the transformer, or connected directly between the grid and plate. Coupling by means of a third transformer winding seems preferable, however, since it has been found to stop d.c. voltage on the crystal and permits grounding of the rotor of a trimmer placed across the crystal.

The division ratios, as high as 10,000 to 1, have been obtained only with a few crystals. However, such extreme ratios would probably seldom be of practical value. A small change in circuit constants might cause the fundamental frequency to change from 1/10,000 to 1/10,001 of the crystal frequency, for instance, and such a small frequency change could easily go undetected with ordinary equipment. Division ratios of several hundred can be readily obtained, however, and maintained with high stability if the supply voltages are held reasonably constant.

A ROARING ATTACK against the intercity networking TV transmission control held by the telephone company appeared in a flurry of briefs filed with the Commission some weeks ago by telecasters, associations, and manufacturers.

Accusing the telephone operators of a "benevolent monopoly," *DuMont* reported that it has continually opposed the discriminatory rates charged for network lines and could find no justification for the government-approved practice of issuing lists of such charges. The FCC was urged by *DuMont* to permit private industry to install microwave relay systems in small towns distant from program service points on existing common carrier routes, and also to supplement existing common carrier facilities.

According to NARTB, private facilities can be installed and operated at

**AUTHENTIC KLIPSCH
DESIGNS...**



From the drawing boards of Paul KLIPSCH, world-famous designer of high fidelity speaker enclosures, come revolutionary new designs which are produced for you by CABINART. Mr. Klipsch is renowned as the developer of the Klipsch corner horn design... an innovation which effectively extends and enhances the bass range of all program material by utilizing the walls of the room in which the unit is placed. Complete freedom from boom and distortion, crispness and clarity of sound reproduction, and smartly styled appearance are some of the qualities which have combined to make Klipsch designs by Cabinart the most truly desired speaker enclosures in the high fidelity sphere.

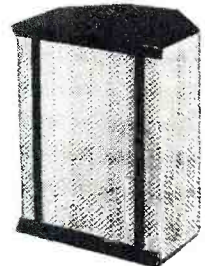

← **KR-5**

Only 20" high, this compact speaker enclosure embodies all of the Klipsch-Quality performance within its miniature size. It can be wall-mounted, corner-hung, placed on a table, a bench, a shelf, anywhere in the home! For versatility... plus performance... plus price... there's nothing like it in the world.

Finished **\$48.00** net
Utility (unfinished) **\$33.00** net

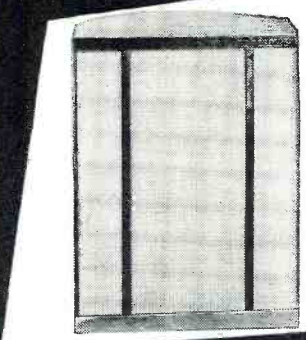

→ **KR-4**

Approved by popular acceptance. Introduced in the Fall of 1953, the KR-4 received the immediate acclaim of critics and music lovers alike. Here is system performance in a Klipsch corner horn speaker enclosure so flexible in design as to provide the widest latitudes in determining your listening requirements.

12" model	{	Finished \$69.00 net
		Kit form \$36.00 net
15" model	{	Finished \$87.00 net
		Kit form \$42.00 net

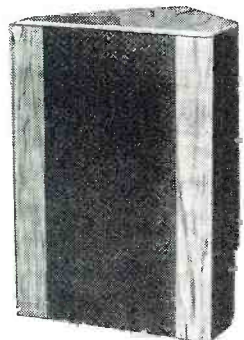

← **KR-3**

Surpassed in performance only by the Klipschorn, the KR-3, based upon the same proven principles, is engineered for loudspeakers up to and including 15" in diameter, coaxial or separate, 2 or 3 way systems. Outstanding versatility unmatched at such low cost.

Finished **\$126.00** net
Utility (unfinished) **\$84.00** net

All three of the Klipsch models are available in a variety of beautiful finishes: Honey Walnut on Walnut, French Mahogany on Mahogany, Korina (Blonde Mahogany), and Ebony (black Lacquer). The KR-5 is also available in a portable leatherette model.

See the Klipsch Models at your local jobber, or write for complete information to Dept. **15-A**
G & H WOOD PRODUCTS CO., 75 North 11th St., Brooklyn 11, N. Y.

New TUBE TESTER

Exclusive

HICKOK

Dynamic

Mutual Conductance

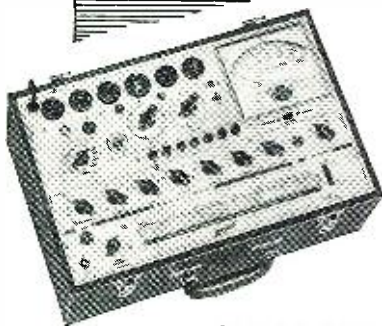

MODEL 600A

This fine tube tester is a lightweight portable. Popularly priced, the 600A is the Radio-TV serviceman and Industrial Technician's favorite. Backed by the HICKOK guarantee and built to the high HICKOK standard, this equipment will provide the necessary completeness and accuracy of tube testing required in the professional maintenance of radio-TV and industrial electronic equipment. HICKOK Dynamic Mutual Conductance circuits permit accurate tube evaluation. AC signal 2.5 volts; 0-3000, 6000, 15000 micromhos. Large, easy-to-read 5" HICKOK-built internal pivot meter. Tests all tubes including Color TV under simulated operating conditions. Includes the HICKOK bias potentiometer. Contains all the latest tube sockets and complete built-in tube reference chart.

This instrument is the lowest priced dependable quality tube tester available. Through increased accuracy and time saving completeness, the 600A will pay for itself in the shortest possible time.

Write today . . . for full details on the world's most complete line of quality vacuum tube testers.

THE HICKOK ELECTRICAL INSTRUMENT CO.
10524 Dupont Avenue • Cleveland 8, Ohio

NEW TV GRANTS SINCE FREEZE LIFT

Continuing the listing of construction permits granted by FCC since lifting of freeze. Additional stations will be carried next month.

STATE	CITY	CALL	CHANNEL	FREQUENCY	POWER*
D. C.	Washington	20	506-512	188
N. Carolina	Washington	7	174-180	251
Ohio	Toledo	79	860-866	166
W. Virginia	Bluefield	6	82-88	50
Washington	Pasco	(Satellite)	19	500-506	10.2

NEW CALL LETTER ASSIGNMENTS

STATE	CITY	CALL	CHANNEL	FREQUENCY
California	Sacramento	KBET-TV	10	192-198
California	Visalia	KAKI	43	644-650
Florida	Tampa	WTVT	13	210-216
Georgia	N. Augusta	WJBF	6	82-88
Indiana	Ft. Wayne	WANE-TV	69	800-806
Indiana	Notre Dame	WNDU-TV	46	662-668
Michigan	Detroit	WJLB-TV	50	686-692
Michigan	Grand Rapids	WMCN	23	524-530
Michigan	Lansing	WTOM-TV	54	710-716
Nebraska	Scottsbluff	KSTF	10	192-198
New York	Binghamton	WINR-TV	40	626-632
Texas	El Paso	KOKE	13	210-216
Texas	Ft. Worth	KFJZ-TV	11	198-204
Texas	Houston	KRTK-TV	13	210-216
Washington	Tacoma	KTVW	13	210-216
W. Virginia	Huntington	WHTN-TV	13	210-216

*ERP = (effective radiated power, kw.) . . . = Call letters to be announced

one-fourth to one-half of the common carrier cost.

A typical comparative cost illustration was introduced by the operators of channel 22, KFSA. They pointed out that with their closest connection to the telephone cable 150 miles away, use of the carrier hookup would cost them about \$5200 a month; but if they installed and operated their own relay, the cost would be trimmed down to about \$2000.

At present the FCC rules permit only temporary private relay systems, KSFSA said that accordingly it has no practical hookup and cannot carry live network shows. The proposed revision to the rules would solve their particular problem.

Manufacturers declared that the relay approval would not only provide better programming for more people and thus prove to be an economic boon to many TV broadcasters, but it would

also lead to the development of improved routing gear, which in the long run would help television industry expansion.

THE MULTIPLE TV STANDARDS now in use in Europe, with six now on the books, were cited recently as the most serious problem which confronts the television industries on the European continent.

In a strongly worded report appearing in the *EBU* journal, the director of the broadcast union's technical center, Angles d'Auriac, declared that the plurality of standards will doubtless continue to hinder seriously the expansion of television in all Europe. No country, he said, can now point to clear, important, and undisputed advantages in its chosen standards, compared with those of the other countries, which are sufficient to outweigh the evident disadvantages caused by the

NEW TV STATIONS ON THE AIR

(As of December 25, 1954)

The following new stations bring the lists published in previous issues up to date.

STATE, CITY	STATION	CHANNEL	FREQUENCY RANGE (IN MC.)	VIDEO WAVELENGTH (IN FT.)	VIDEO POWER (IN KW.)
Kansas					
Great Bend	KCKT	2	54-60	17.8	100
Kentucky					
Lexington	WLEX-TV	18	494-500	1.99	171
Missouri					
St. Louis	KETC†	9	186-192	5.25	29.5
New York					
Bloomingtondale	WIRI	5	76-82	12.8	20
Oklahoma					
Tulsa	KVOO-TV	2	54-60	17.8	100
Pennsylvania					
Allentown	WFMZ-TV	67	788-794	1.25	80
Texas					
Houston	KTRK-TV	13	210-216	4.65	316
WLBR-TV, channel 15, Lebanon, Pennsylvania, has gone off the air.					

The frequency of the video carrier = 1.25 + channel lower freq. limit. Total number of TV stations now on the air in U.S.: 416 (123 of which are u. h. f.). †Educational.

number of television standards which prevail.

Outlining the problems which too many standards have created, the *EBU* expert listed curtailed direct program exchange and international relays. It was also noted that direct reception of foreign TV programs was difficult under the present plan. Converters were not effective, the analyst said, and multi-standard receivers must be used. This requirement was described as a taxing one, since involved circuitry must be built into the sets and costs soar. The variables have made it difficult for receiver manufacturers to establish any standards of design and production, or mass techniques of manufacture.

The report also revealed that the number of standards, which has necessitated overlapping of channels and asymmetrically disposed carrier frequencies, has complicated the solution of the protection problem and increased its seriousness. When one studies the selection of the i.f.'s and more generally the susceptibility of sets to interference of all kinds, the *EBU* statement added, one realizes how valuable standardization would be. It was noted, it would not only be possible to protect the i.f. channel, but the problem of spurious responses would be much easier to solve in a regularly-divided spectrum, with the carrier frequencies uniformly arranged, than in a "higgledy-piggledy" spectrum, such as will exist soon when

a sufficient percentage of transmitters go on the air in Europe.

THE SATELLITE program, catalogued as a remote possibility only a few months ago, broke out of the crystal ball in the early winter months and became a practical fact, when the Commission told KIMA-TV in Yakima, Washington, that it could repeat its channel-29 programs on channel 19 via a station in Pasco, 74 air miles from the mother station. The slave will transmit on an e.r.p. of 10.2 kw. using an antenna on Badger Mountain.

The Commission has also been able to clear its v.h.f.-u.h.f. decks a bit and issue several more grants, plus a number of new calls as listed on page 134, this issue.

PRACTICAL ELECTRONIC LIGHT amplification, thanks to intensive TV research, is not too distant, according to *RCA's* board chairman, Brig. Gen. David Sarnoff.

At a luncheon meeting in St. Louis, in observance of Light's Diamond Jubilee, he said that light amplification has already been produced in ratios of more than 20, and further progress is certain to be made. Praising the scientists who have propelled this advancement, Sarnoff said that he has always proceeded on the theory that whatever the mind of man can imagine, the mind of man can ultimately produce. And here was a striking illustration. . . . L.W.



Investigate

TERMINAL'S Sensational "5-STAR" Hi-Fi BUY!

Complete FM-AM-Phono Radio System
All brand new. Fully guaranteed. Ready to plug together and play. Consisting of famous name components as follows:

- CRAFTSMEN C800A De Luxe FM-AM Tuner...Net \$159.50
- CRAFTSMEN C500A Ultra Fidelity Amplifier...Net \$99.50
- GARRARD RC80 3 Speed Record Changer...Net \$49.50
Special "45" Spindle...Net \$3.50
- ELECTRO-VOICE 12 TRXB Triaxial Speaker...Net \$59.70
- GENERAL ELECTRIC RPX-050
Triple Play Magnetic Pickup...Net \$8.20

Total regular...Net \$379.90

This Complete System NOW at TERMINAL

Only \$259.
f.o.b. our store

Never before such fine Hi-Fi at such low cost. See and hear it at our Sound Studios or send for Bulletin RN-1. Write today.

Terminal Radio CORP.
85 CORTLANDT ST., NEW YORK 7, N. Y. • WOrth 4-3311

COYNE offers LOW COST TELEVISION RADIO-ELECTRONICS Training in Spare Time AT HOME



The future is **YOURS** in TV-RADIO!
A fabulous field—good pay—fascinating work—a prosperous future! Good jobs galore, or independence in your own business!

Coyne brings you the first **truly lower cost**, MODERN—QUALITY Television Home Training; training designed to meet Coyne standards. Not an old Radio Course with Television "tacked on". Here is MODERN TELEVISION TRAINING including working knowledge of Radio. Includes **UHF AND COLOR TV**. No Radio background or previous experience needed. Personal guidance by Coyne Staff. **Practical Job Guides** to show you how to do actual servicing jobs—**make money early in course**.

With Coyne Television Home Training you pay only for your training, **No Costly "Put together kits"**.

COYNE ELECTRICAL SCHOOL
A TECHNICAL TRADE INSTITUTE OPERATED NOT FOR PROFIT
500 S. Paulina Street, Chicago 12, Dept. 15-TR5

B. W. COOKE,
President



Coyne—the Institution behind this training... the largest, oldest, best equipped residential school of its kind. Established 1899. Send coupon for details.

MAIL COUPON FOR FREE DETAILS

including information about easy Payment Plan. **No obligation, no salesman will call.**



COYNE ELECTRICAL SCHOOL
Television Home Training Div.
500 S. Paulina St., Chicago 12, Ill., Dept. 15-TR5

Send Free Picture Folder and details on Television Home Training. This does not obligate me and no salesman will call.

Name _____
Address _____
City _____ State _____

Check here if interested in Resident School Training in Chicago.

TERADO



Trav-Electric CONVERTERS

Provide

House Current Anywhere

—from battery in car, truck, boat. At the beach—picnic grounds—at cabin—on trips—anywhere!

Easy! No installation! Just plug Trav-Electric into cigar lighter on dash.

Trav-Electric Operates:

- Tape Recorders
- Electric Shavers
- Radios
- Soldering Irons
- Dictating Machines
- Small Electric Drills
- Portable Phonographs
- Etc., etc., etc.

6 Models—10 to 100 Watts

—a size for every need

"MIDGET"

Model 6-11160
10-15 Watts
About as small as a
pack of cigarettes
\$11.95 LIST

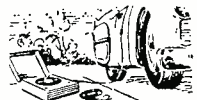

PORTABLE PHONOGRAPH



Dictating Machine



ELECTRIC SHAVES

"JUNIOR"

Model 6-1110
115 Cycle—30-40 Watts
\$12.95 LIST

"SENIOR"

Models 6-11160
Size 2 1/2" x 2 1/2" x 4 1/2"
35-40 Watts
\$15.95 LIST

"MASTER"

Model 6-51160
40-50 Watts
Size 4" x 5" x 6"
\$27.50 LIST

"SUPER"

Model 6-71160
(Shown at top of ad)
60-75 Watts
Size 4" x 5" x 6"
\$37.95 LIST

—and now, the "CHIEF"

New—just out—Model 6-81160—75-100
Watts—automatic on-off switch—
\$49.95 LIST

See your Electronic, Hardware,
or Automotive Jobber or Dealer

Terado Company

Designers and Mfrs. of Electronic Equipment
1058 Raymond Ave., St. Paul 14, Minn.

In Canada Write: Atlas Radio Corp., Ltd.
560 King St. West, Toronto 28, Ont.
Export Sales Division: Scheel International, Inc.
4237 N. Lincoln Ave., Chicago 18, Ill., U.S.A.
Cable Address—Harsheel

Certified Record Revue

(Continued from page 70)

this speed. I venture to say that 7 1/2 inch speed with extended range will become the "standard" of the consumer tape machine market.

Well, that's about it for the 1954 New York Audio Fair. There were many other pieces of equipment and gadgets and "gizmos" which I cannot mention here because of space limitations. To those who were omitted, my apologies.

With all this Fair yak, I will have to cut the length of the reviews in order to bring to your attention as many of the new records as possible. Equipment used this month: *Components Corporation* turntable, *Fairchild* arm and *ElectroSonic* cartridge, *National* pre-amp and 20 watt amplifier, *Electro-Voice* "Georgian" speaker, *Ampex* 600 tape equipment.

RICHARD STRAUSS DER ROSENKAVALIER

Maria Reining, Hilde Gueden, Sena Jurinac, Ludwig Weber, Alfred Poell, Anton Dermota, and other soloists, Chorus of the Vienna Staatsoper, Vienna Philharmonic Orchestra conducted by Erich Kleiber, London LLA-22. RIAA curve. Price \$23.80.

One is inclined to take advertising claims with more than a grain of salt. When London touted this album and the previous *Salome*, as "the dawn of a new era in operatic recording," you couldn't help thinking in spite of London's great reputation in opera, this was a pretty strong statement. But by golly, they weren't kidding! Their magnificent *Salome* soon dispelled any notion that their "new era" was just a copywriter's pipe dream. And if London's subsequent opera releases are even remotely as good as this *Der Rosenkavalier*, truly, the "new era" has arrived! I cannot recommend this recording too highly. From every conceivable aspect; of casting, of performance, of technical excellence, this is the greatest opera recording since the advent of the long play record, and surely one of the best of all time! Maria Reining's Marschallin is a thing of exquisite charm, warm and mellow, and properly—just a little wistful. Even the most fanatic follower of Lotte Lehmann must admire this superb artistry. Sena Jurinac as Octavian is priceless. A more supple voice for this role is hard to imagine. Sheer magic is her vocal imagery and her phrasing and coloration must take the larger bow for this. Hilde Gueden is the perfect Sophie. The lustre and patina of her superb voice guide her through the pitfalls of her ingenue role, and make for an altogether delightful portrayal. Ludwig Weber is well known for his performance as the Baron Ochs and in this recording he is as effective as always. His darkly resonant voice is perfectly suited to the role of a gross boor, who withal, is still an aristocrat. Weber neither overplays nor underplays these several aspects of his role, and his singing, especially in his lower registers, is magnificent. Throughout the recording, even unto the smallest role, the singing is of the highest order.

Much of the success of this recording must be credited to conductor Erich Kleiber. His is the strong guiding hand that holds this huge production together, yet is light enough on the reins, to maintain the flow and beauty of the score. You realize that he knows this is an opera he is conducting, and he wants the singers to sing—not to act as a captive audience for conductorial bombast. The Vienna Philharmonic plays for him with that bright sheen of perfection which is always there for the knowing conductor. Soundwise, this is

positively the best ever afforded any opera. Strings are silky smooth, yet have the bite and authority when needed. Warmth and superb intonation are a feature of the woodwinds. Brass is bright and clean, and percussion is sharp and accurate without being obtrusive. All this is extremely wide range and remarkably distortion-free. Splendid balance and just enough reverb keep the vocalizing completely articulate. A German-English libretto is furnished so you can follow the action. If you have to beg, borrow, or steal, don't miss this recording!

RAVEL LA VALSE FAURE PAVANNE (OPUS 50) FRANCK PSYCHE

Detroit Symphony Orchestra conducted by Paul Paray. Mercury MG50029. RIAA curve. Price \$5.95.

Another champion is crowned! Yessir, it's going to take some doing to beat this *La Valse* of Paul Paray. Certainly in the most propulsive and exciting version of this score on records, Paray shows once again his proclivity for Ravel. His tempi are fairly straightforward, but at that point any similarity to other recordings ends. To the exuberance of the work he adds just the right amount of earthy burlesque. From his first class orchestra, Paray elicits a performance that blazes with color and his dynamic shadings are simply incredible, in fact, they are such that without the fabulous recording he is afforded, they wouldn't come off very well. Yes, the dynamic range on this disc is truly startling when you play it for the first time. Throughout *La Valse* the sound is extraordinary, with clean edgeless strings, super-bright brass and woodwinds, and some tremendous bass drum and tympani sounds. In the finale, this heavy battery is augmented with huge crashing cymbals and a great gong and the climax is literally shattering! The Faure *Pavanne* is in violent contrast to *La Valse*, being a quietly beautiful and melodious little work, enjoying its debut on LP. The Franck is a quasi-mystical sort of thing, quite unlike the Franck most of us know. Both the Faure and Franck are well played and recorded, if less spectacular than *La Valse*. The RIAA curve did not require adjustment. Quiet surfaces.

ANTHEIL CAPITAL OF THE WORLD BANFIELD THE COMBAT

Ballet Theatre Orchestra conducted by Joseph Levine. Capitol P8278. RIAA curve. Price \$5.95.

Joseph Levine has so far made a perfect score in the quality of his recordings for Capitol. These two bright and colorful modern ballets are no exception. Levine knows the ballet idiom and this is revealed in his sure beat and tempi, the smooth line and flow of the music. I find the *Capital of the World* the more interesting musically of the two works herein recorded. Based on Hemingway's story about a boy and his dreams of becoming a bullfighter, the music is of course Spanish in flavor and is extremely colorful. Two unusual aspects of the work are that it had its premiere on the "Omnibus" television program (Dec. '53) and a flamenco dance section is actually danced by the star of the ballet, Roy Fitzell. The flamenco hand clapping, foot stomping, finger snapping, and thigh slapping, make for exciting transients, which are perfectly reproduced.

The Combat is the story of Tancred and Clorinda, which has been utilized before, notably by Monteverdi. More somber in its orchestral hues than the Antheil score, it is nonetheless a highly listenable and cleverly

NOW!

ARROW SALES OFFICES!



**FASTER SERVICE!
LOWER SHIPPING COSTS!
BIGGER SELECTION OF ELECTRONIC EQUIPMENT**

3 LOCATIONS FOR EVERYTHING IN ELECTRONICS!

- ★ 7460 VARNA AVE., NORTH HOLLYWOOD, CALIFORNIA (Mailing address: Box 3878, N. Hollywood, Cal.)
- ★ 2441 SOUTH MICHIGAN AVENUE, CHICAGO 16, ILLINOIS
- ★ 2005 EMPIRE AVENUE, BURBANK, CALIFORNIA

Mail order buyers: direct your mail to either the North Hollywood or Chicago mailing address—whichever is closer. Buyers wishing to inspect or purchase equipment: please visit our sales-showrooms in Burbank, California, and Chicago, Illinois. (Addresses above).

INDICATOR SCOPE ID6A/APN4



Made to operate in conjunction with Radio Receiver 1B9/APN-4. Unit includes one 5" scope tube, crystal controlled standard oscillator, sweep circuits, marker pulses. Good cond. Weight 40 lbs.

WITH TUBES & CRYSTAL..... **\$19.95**

MICA CAPACITOR

.00005 MFD. 300V. Made by Cornell-Dubilier Co. Ideal cap. for lab. and experimental use. Wt. 3 lbs. New..... **\$2.95**

BC-191 TRANSMITTER

100 W. With tubes, modulation section, speech amplifier for T-32 mike, RF meter, 0-500 MA meter, 0-15 DC filament meter. Plus schematic for converting this transmitter for AC operation. FREE: ONE TUNING UNIT with each transmitter! Excellent cond. **\$24.95**
T-32 CARBON MIKE. Used, good cond. **\$2.95**
ONE SET PLUGS: For BC-191. New..... **\$1.95**

SOULD POWERED HANDSET. Ex. cond. Ea. **\$ 5.50**
2 for **10.00**
T-26 CHEST MIKE. New..... **1.45**

FL-8 RANGE FILTER. **1.95**
FL-5 RANGE FILTER, NEW, 79c; 5 for..... **3.00**

ARC-4 MOBILE TRANSCEIVER

1-10-144 MC. Complete with control box, tubes, 12/24 VDC dynamotor with schematic. Excel. cond. Wt. 38 lbs..... **\$32.50**

HORSIE TALKIE BC-745

Low powered, portable, amplitude-modulated voice communication sets. Powered by either wet or dry battery. Freq. range: 2,000-6,000 Kc. Operating range: about 5 miles. Set is turned on by fully extending telescopic antenna rod; when retracted, set is turned off. With one tuning unit. Weight: 19 lbs. SPECIAL..... **\$7.95**

A HAM'S DREAM!

APX-2 IFF EQUIPMENT. This transceiver is a treasure-house of tube sockets, coaxial fittings, resistors, condensers, microswitches, amphenol connectors and a raft of other parts. Less tubes and motor. Wt. approx. 30 lbs. F.O.B. North Hollywood ONLY. SPECIAL..... **\$4.95**



234-258 MC RECEIVER

11-tube UHF tunable receiver with schematic. Like new. **\$14.95** Wt. 10 lbs.
Rack **\$3.50**
Control Box..... **1.50**

UHF TRANSMITTER-RECEIVER APS-13

\$3.95

Freq. range 415-420 MC. 5 stages of 30 MC. 1P amplifier. Complete with R.P. and I.F. sections. Less dynamotor, tubes, and tube shields, with schematic. Excel. cond. Weight 14 lbs.

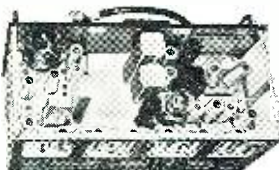

COMMAND EQUIPMENT

TRANSMITTERS	USED
BC-437 4 to 5.3 MC.....	\$ 6.95
BC-438 5.3 to 7 MC with tubes.....	5.95
The above pair.....	11.90

RECEIVERS	
190 to 550 KC Famous Lazy 5 Q'er.....	10.95
BC-454 3 to 6 MC.....	7.95
BC-455 6 to 9.1 MC.....	7.95

MN-28C CONTROL BOX. New..... **\$12.50**
MR-9B CONTROL BOX. New..... **14.95**

WIRE-WOUND POWER RESISTORS

2500 Ohms 75 W. Ohmite. Adj.	
Ea.	85c 10 for \$7.50
25 Ohms 75 W. Ohmite. Adj. Ea.	85c 10 for 7.50
100 Ohms 100 W. I.R.C. Adj. Ea.	85c 10 for 7.50
25 Ohms 50 W. Ohmite. Adj. Ea.	85c 10 for 7.50
300 Ohms 50 W. Ohmite. Adj. Ea.	85c 10 for 7.50
100 Ohms 25 W. 9 taps. Ea.	69c 10 for 5.95
1500 Ohms 40 W. 9 taps. Ea.	69c 10 for 5.95

BC-610 TUNING UNITS

TU-49: 3.2-4.0 MC. Wt. 4 lbs..... **\$2.95**
TU-50: 4.0-5.0 MC. Wt. 4 lbs..... **2.95**

RG-7/U CO-AXIAL CABLE

Co-axial RF transmission line for military laboratory, police, broadcast and other industrial purposes. 97.5 ohms imp. dia. .370 new cable, special in 100 ft. rolls or 500 ft. reels. **\$3.95** Ea.
100 ft. Roll..... **14.95** Ea.

5BP1 5" SCOPE TUBE. Ea. **\$1.95**
3 for **\$4.95**

ARB NAVY RECEIVER

105 to 9050 KC. Four Bands, Calibrated Dial, LF Ship-BC-80 & 40 Meter—Complete with Tubes and Dynamotor. For 24 Volt operation; easily converted to 110 V—12 or 6 Volt. Size 8 1/4" x 7 1/4" x 15 1/4". Excellent cond. With schematic. Weight 30 lbs..... **\$19.95**



C.A.P. SPECIAL BC-625 VHF TRANSMITTER
Freq. range 100-156 MC. With modulation section and speech amplifier. Less tubes & crystals, with conversion dope. Used, good condition. (See Nov/53 CQ.) Wt. 17 lbs..... **\$9.95**

UHF TRANSMITTER

1 tube. Frequency range: 397 MC. For remote control of model boats, planes, etc. With tube, antenna. Less battery. Size of transmitter: 4 1/4 x 2 1/4 x 6". New..... **\$2.95**

NEW! CD-508 CORD SPECIAL!
Has PL-68 plug and 7 ft. 3-wire mike cord, hand switch and JK-48 jack. New..... **\$1.49**

TG-10 CODE KEY

Self-Contained Automatic unit for code practice signals from an inked type recording. Complete with 7 tubes and electric eye. Audio freq. output of 800 CPS. Size: 11 x 24 x 18 1/2" —110-250 VAC 60 cy.—78 RPM motor can be used for a turntable—Power unit can be used for a P.A. system—wt. 85 lbs. Used, clean cond..... **\$14.95**

BC-604 35 W. FM TRANSMITTER

For 20-27 MC. band. Ideal for 10-11 meters. Complete with tubes, temperature controlled crystal oven with schematic. Less dynamotor and crystals. Excel cond. Wt. 60 lbs..... **\$11.95**



SPECIAL PURPOSE TYPE NO. SC-M CURRENT RELAY

Relay adjustable from 0.2 to 1.0 amps. External push-button reset. Enclosed in glass case. Hand calibrated adjustments. Wt. 4 lbs. NEW. Ea. **\$4.95**
2 for **\$8.00**

ECHO BOX

A hand tuned ring box with an associated dipole which picks up the RF energy from the radar set. Frequency range of 3140-3640 MC. Ideal unit for experimental lab. Wt. 7 lbs. New Condition..... **\$4.95**

RT-7/APN-1

Transmitter-receiver unit with a frequency range of 420-460 mc FM. Ideal set for getting started in frequency-modulation theory. This set uses 14 tubes including a voltage regulator circuit, counter circuit. Many precision resistors, relays and tube sockets. Real buy for experimental use. LESS TUBES, DYNAMOTOR AND WOBBULATOR. With schematic. Wt. 18 lbs. Excellent condition..... **\$4.95**

COMMAND TRANSMITTER

NEW TUBE KIT
Consists of: 2-1625, 1-1626, 1-1629. Wt. 2 lbs. SPECIAL PER KIT..... **\$1.19**

TRANSMITTER-RECEIVER

Complete unit with 9 v DC input dynamotor to supply the necessary 450 v DC @ 75 ma. Frequency range 160-211 MC. Set has 13 tubes, high voltage power supply. In like new condition. Wt. 43 lbs. A real buy..... **\$14.95**

NEW HAM CIRCULAR!

Ask for your FREE copy!
Drastic reductions on selected hot items!

All shpts. F.O.B. where, N. Hollywood or Chicago, Calif. or Illinois residents add sales tax. 25% deposit required. Specify shipping instructions and ADD SHIPPING COSTS TO EACH ORDER. All items subject to prior sale and change of price without notice. Direct all mail to N. Hollywood or Chicago mailing address.

ARROW SALES, INCORPORATED

Western Mailing Address

P. O. BOX 3878, NORTH HOLLYWOOD, CAL.
Office-Warehouse: 7460 Varna Ave., N. Hollywood, Cal.
Phones: STanley 7-6005, POplar 5-1810

Central Mailing Address

2441 S. MICHIGAN AVE., CHICAGO 16, ILL.
Phone: CALumet 5-9313
(CABLE ADDRESS: ARROWSALES, N. HOLLYWOOD
TELEGRAPH ADDRESS: WUX, N. HOLLYWOOD, CAL.)

Visit our sales-showroom at 2005 EMPIRE AVE., BURBANK, CAL. Phone: Victoria 9-2834

In the Chicago area, visit sales showroom at 2441 S. Michigan Ave., Chicago, Illinois.

JOHN F. RIDER PERSONALLY GUARANTEES THIS BOOK!

He wrote it . . . he knows how good it is . . . and here's the amazing guarantee he makes:

"I'm SURE you'll find my new book worth many, many times the price you pay! While it's customary in the book field to give a 10 day examination period—I'LL GIVE YOU 60 DAYS! If, at the end of that time, you want to return the book for any reason whatsoever, send it back to me and I'll refund your full purchase price, regardless of where you bought it!"

JOHN F. RIDER

OBTAINING & INTERPRETING TEST SCOPE TRACES only \$2.40

WHY WE'RE SO SURE YOU'LL WANT TO KEEP THIS BOOK:

John Rider has written more books on the oscilloscope than any other author in America—he's an expert on scopes! His newest book, "Obtaining & Interpreting Test Scope Traces", actually gives you a technical background—an education in waveform analysis in non-mathematical terms! Over 800 illustrations show you the ideal version, practical version, and distorted version of the most-commonly-encountered scope traces! This book explains the causes of distorted waveforms—tells you how to distinguish good waveforms from bad—covers scope traces of all types: AM radio receivers, FM radio receivers, TV receivers, audio amplifiers, power supplies, test equipment! Here is a completely practical book that tells and shows you how to apply the scope!

CHAPTERS: Sine & complex waveforms—Square waveforms—Rectangular waveforms—Sawtooth & trapezoidal waveforms—Differentiated and integrated waveforms—Amplitude-modulated waveforms—Response & S curves—Interpretation of test scope traces—Phase & frequency scope traces—Test set-ups.

HOW YOU CAN TAKE ADVANTAGE OF THIS SENSATIONAL OFFER:

1. Buy a copy of "Test Scope Traces". You can get it at your jobber's store . . . your book store . . . or, if your dealer doesn't have it, you can get it by mailing the coupon below to us.
2. Examine this important new book in your own home or shop, at your leisure. This guarantee offer is good until midnight, Feb. 28, 1955. After you've seen the wealth of information on scope traces that this book gives you—decide if it's worth keeping. If you're not completely satisfied, for any reason whatsoever, return the book to us before midnight, Feb. 28, 1955 and we'll gladly refund your complete purchase price! This offer is limited to the continental United States. Canadian price approximately 5% higher.

ORDER TODAY!

JOHN F. RIDER PUBLISHER, INC.
480 Canal Street, N. Y. C.

Please RUSH me . . . copies of "Test Scope Traces" @ \$2.40 each. If not completely satisfied, I may return these books before Feb. 28, 1955, and receive a complete refund.

Name
Address
City & State

wrought work. Both works are splendidly recorded, with fine clean strings, good brass and percussion. Nice acoustic perspective. The RIAA curve was OK as is.

SCHUMANN

PIANO CONCERTO IN A MINOR
SCENES FROM CHILDHOOD
Guiomar Novaes, Piano; Pro Musica Orchestra conducted by Hans Swarowsky. Vienna Vox PL8540. NARTB curve. Price \$5.95.

This concerto has always been the particular forte of Madame Novaes. Her earlier recording on this same label was greatly admired and it is a pleasure to hear this more up-to-date recording and note that time has not dimmed the lustre of her performance. Her interpretation of Schumann still sings, an expressive lyrical loveliness. Yet her reading has strength and vigor. Her only competition is the Lipatti-von Karajan on Columbia. His was a sensitive performance, but I still prefer the Novaes. She has the advantage of a great deal more sonic splendor in the recording. The recording contains some of the finest piano bass I have heard. The over-all sound is wide range in frequency and dynamics and an exceptional balance is maintained by conductor Swarowsky and his men. Madame Novaes' *Kinderscenen* is played with finesse, but I believe Gieseking and Curzon have a little edge in expressiveness. If you're looking for a new Schumann piano concerto, you won't go wrong on this one. NARTB curve was adequate and surfaces were quiet.

HORN CONCERTOS

Dennis Brain, French horn; Philharmonia Orchestra conducted by Herbert von Karajan. Angel 35092. RIAA curve. Price \$5.95.

Few virtuosi have ever earned the admiration and respect that is universally accorded Dennis Brain. His name has become almost synonymous with the French horn. If you would like to find out why, I direct your attention to these four horn concertos of Mozart. You will be treated to one of the most incredible sounds in music—the rich, noble, and mellow tones of a French horn playing in difficult rapid scales, leaping from low to high register and vice versa; in short, a master of the horn performing seemingly impossible tonal gymnastics. A more wonderful vehicle for Mr. Brain's talents than these Mozart concertos would be hard to imagine. Superbly constructed, they are gay and colorful works, filled with typical Mozartian light-heartedness. Von Karajan and the splendid Philharmonia furnish a perfectly balanced accompaniment to Mr. Brain. The fine engineering has captured the soaring beauty of the horn and given a bright sheen to the orchestra. The wide frequency and dynamic range, and low transient distortion of this disc are responsible for the newly revealed riches of these concertos. The RIAA curve was better with a few db of bass boost. Very quiet surfaces.

A CELLO RECITAL

Paul Olefsky, cello; George Silfies, piano. McIntosh MM103. Price \$5.95.

AN EXPRESSION OF MUSIC FOR VIOLIN AND CELLO

Gordon Staples, violin; George Silfies, piano. McIntosh MM101. Price \$5.95.

A PIANO RECITAL

James MacInnes. McIntosh MM104. Price \$5.95.

No, you're not seeing things. The name of this recording company is *McIntosh*, and it is the same company who makes those high quality amplifiers. Don't ask me how they got into the music business; I wouldn't know! As you can see the initial endeavor is mainly in the direction of solo and chamber works.

They were not recorded haphazardly, however. *McIntosh* has an idea that a really high quality recording of solo instruments, recorded with the *proper acoustic perspective*, will sound "at home" in the average living room. They contend (and I believe rightly so) that solo instruments which are recorded in a large hall with the *acoustical properties of that hall included* are out of place in a living room. Sure, there is plenty of room for argument here. You are saying that if this is true, then a symphony orchestra with large hall reverb, certainly doesn't belong in the living room. Well, remember this; reverb is given to a symphony orchestra to *enhance* the "presence" effects and give the *illusion* of depth or spaciousness. In a sense the music is "tailored" to your living room, or you are "brought" to the concert hall! You can't cram a symphony orchestra into the average living room; but you can have a cellist playing in your room. Why not then record the cellist to sound as if he were "on hand" rather than in a mammoth hall? This *McIntosh* has done, and most successfully. The sound here has indeed, a "living presence" effect, a "close to" type of recording which reveals the instruments with startling clarity. These are the "you can hear the rosin" sort of recordings, but without the usual penalty of screech or edginess to the strings or overload on the pianos. Musically, these are pot-pourris of works in the standard repertoire and are well played by better than average artists. Of the three discs, I like the cello best. The rich dark sound of the cello is amazingly "live" and is an excellent disc for demonstration. That's about it, except to point out one glaring and rather funny "boo-boo." No curve information—and this from a preamp manufacturer! However, the discs sounded all right with the AES curve.

BERLIOZ

TE DEUM (OPUS 22 FOR TRIPLE CHORUS, SOLO TENOR AND ORCHESTRA)

Royal Philharmonic Orchestra conducted by Sir Thomas Beecham with Alexander Young, tenor; London Philharmonic Choir; Dulwich College Boys Choir; Dennis Vaughan, organist. Columbia ML4897. NARTB curve. Price \$5.95.

The use of the word "monumental" may smack of cliché, but what else can you say about a work like this? Proportioned on the same heroic scale as his *Requiem*, this is a long awaited Berlioz work. How fortunate we are to have the redoubtable Sir Thomas in charge of proceedings! Long experience with oratorios and other massive works has given him a sense of "rightness" and balance that few other conductors can approach. Along with the enormous difficulties the recording engineers must surmount, his is the job of keeping a great work like this articulate and of careful handling of tonal masses so that the vocal textures never blur or "muddy-up." That he has succeeded as well as he has within the framework of this mighty score, is high tribute indeed. True, there are more than a few moments when the power of the *Te Deum* is beyond the ministrations of Sir Thomas, the recording engineers, or anyone else! Along with the *Requiem*, certainly it is one of the most thrilling and exciting large scale choral works ever written. If you want to hear something overwhelming, listen to the "Christe, Rex Gloriae" and the finale "Judex Crederis." The massed voices, the brilliant blare of the trumpets, and the thunder of bass drum, tympani, and organ is stunning in its impact. The Royal Philharmonic plays magnificently and the choirs cope with the score in assured and confident voices. Mr. Young is more than adequate for the demands of his role. Soundwise, this is generally quite wide

ELECTRICAL ENGINEERS

or

PHYSICS GRADUATES

with experience in

RADAR or ELECTRONICS

or those desiring to enter these areas...

*The time was never more opportune than now
for becoming associated with the field of advanced electronics.*

*Because of military emphasis this is the most
rapidly growing and promising sphere of endeavor for the young
electrical engineer or physicist.*

range, with terrific dynamics. In spots the transient response could be better and some distortion creeps in now and then, which might be expected in a work like this. The organ is properly sonorous and in the "Judex" the huge bass drum blasts are quite clean. The splendid acoustic treatment has much to do with the effectiveness of the recording. The NARTB curve was better with a couple of db bass boost, to my ears. Good surfaces.

BIZET **L'ARLESIENNE SUITES** **#1 AND #2**

L'Orchestre De La Radiodiffusion Nationale Belge conducted by Franz Andre. Telefunken LGX66021. RIAA curve. Price \$5.95.

Of the many versions of these colorful suites, this is one of the best sounding and well performed of recent memory. Andre has shown a particular facility for this work and others of similar genre. If his reading is not inspired, it is at very least, honest. And this honesty is good for the work which has suffered at the hands of more pretentious conductors. Andre's is a good linear performance with emphasis on the rhythmic aspects without slighting its lyric qualities. His orchestra is far better than the usual radio group and is very responsive to his demands. The sound is what we have come to expect from Telefunken. Not spectacular, but a fine, clean "big hall sound," very transparent in character. Frequency response and dynamic range are more than acceptable. Good transients throughout the disc. The RIAA curve was better with a little bass boost.

VAUGHAN WILLIAMS **SINFONIA ANTARCTICA**

London Philharmonic Choir and Orchestra conducted by Sir Adrian Boult with Margaret Ritchie, soprano; superscriptions spoken by Sir John Gielgud. London LL-977. RIAA curve. Price \$5.95.

If ever a piece of music called for sitting in front of a roaring fire and a noggin' o' good hot buttered rum, this is it! The music makes no pretense. It is frankly programmatic and makes no bones about it. However, it would be very wrong to label this as merely background music for the British film, "Scott of the Antarctic." It is far, far, more than that. Vaughan Williams has expanded the original movie score and has made of it a very personal utterance, depicting in essence, the interminable struggle of man against nature and the seemingly insurmountable. Given the proper atmosphere, this music weaves a powerful spell. The orchestration is unique, to say the least. Among other things are the poetic "superscriptions" beautifully spoken by Sir John Gielgud and the wordless female chorus that appears in the first and the last sections of the work. Couple this with an eerie wind machine that sounds like desolation itself, and the wailing of a solo female voice (Margaret Ritchie) and you have a gripping and compelling picture of icy wastes. There are sections in this work that really will send cold chills up and down your spine! Before the "ice fall" scene a great organ speaks out in thunderous splendor. Throughout the score you meet the unexpected. The last few bars, with the wailing voice and the howl of the wind gradually dying away, is one of the loneliest sounds on God's earth. The wide range sound on this disc, the great dynamics, the cleanness of transients, make this a hi-fi showpiece and I most highly recommend this to you for an unusual and thrilling experience.

BERLIOZ **THE DAMNATION OF FAUST** **Boston Symphony Orchestra conducted**

January, 1955

Since 1948 Hughes Research and Development Laboratories have been engaged in an expanding program for design, development and manufacture of highly complex radar fire control systems for fighter and interceptor aircraft. This requires Hughes technical advisors in the field to serve companies and military agencies employing the equipment.

As one of these field engineers you will become familiar with the entire systems in-

cluded, including the most advanced electronic computers. With this advantage you will be ideally situated to broaden your experience and learning more quickly for future application to advanced electronics activity in either the military or the commercial field.

Positions are available in the continental United States for married and single men under 35 years of age. Overseas assignments are open to single men only.



Hughes Field Engineer H. Heaton Barker (right) discusses operation of fire control system with Royal Canadian Air Force technicians. Avro Canada CF-100 shown at right.

Relocation of applicant must not cause disruption of an urgent military project.



Scientific
and
Engineering
Staff

HUGHES

RESEARCH
AND
DEVELOPMENT
LABORATORIES

Culver City,
Los Angeles
County,
California

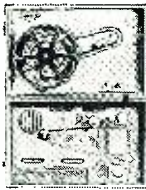

TG-34A CODE KEYS

Self-contained automatic unit, reproduces code practice signals recorded on paper tape. By use of built-in speaker, provides code-practice signals to one or more persons at speeds from 5 to 25 WPM. **BRAND NEW, in original carton... \$18.95**

Used. Excellent Cond. \$12.95

TG-10 CODE KEYS, complete with 7 tubes and electric eye. 65 lbs. **BRAND NEW... \$17.50**

FL8-A RADIO FILTER... **\$1.59**

HEADPHONES

Model	Description	Excellent Used	BRAND NEW
H5-23	High Impedance	\$2.25	\$4.35
H5-33	Low Impedance	1.79	4.65
H5-30	Low Imp. (leatherwt.)	1.49	1.85
H-16/U	High Imp. (2 units)	2.75	7.95
CP-307A	cords with PL55 plug and JK26 Jack		.88

MICROPHONES

Model	Description	Excellent Used	BRAND NEW
T-17	Carbon Hand Mike	\$5.45	\$7.95
T-30	Carbon Throat Mike	.33	.69
T-45	Navy Lip Mike		1.25
RS-38	Navy Type	1.95	5.95
T-24	Carbon Mike		3.95

SCR-274 COMMAND EQUIPMENT

Type	USED	Excellent Used	BRAND NEW
BC-453 Revr. 190-550 Kc.	\$48.50	\$21.50	\$37.50
BC-454 Revr. 3-6 Mc.	8.25	11.25	19.50
BC-455 Revr. 6-9 Mc.	7.95	10.95	15.45
BC-456 Modulator		2.75	15.65
BC-457 Xmtr. 4-5.3 Mc.	11.95	14.50	22.95
BC-458 Xmtr. 5-3 Mc.	7.95	9.75	21.95
BC-459 Xmtr. 7-9 Mc.	11.95	12.95	21.25
BC-696 Xmtr. 3-4 Mc.	18.95	27.95	
BC-450 3-Rev Control Box		1.49	1.95
BC-451 Xmtr. Control Box		1.25	1.45
3-Receiver Rack		1.79	2.95
2-Transmitter Rack		1.59	3.25
Single Transmitter Rack			3.25

FAMOUS BC-645 XMITTER-RECEIVER



Makes wonderful mobile rig for 420-500 Mc. Easy to convert for phone or CW 2-way communication. **CONVERSION DIAGRAM INCLUDED.** This swell rig originally cost over \$1000—yours for practically a song! You get it all in original factory carton. **BRAND NEW**

NiW, complete with 17 tubes, less power supply. Shpg. wt. 25 lbs. **\$29.50**

PE-101C DYNAMOTOR for BC-645, has 12-24V in/out (easy to convert for 6V Battery operation) **\$4.85**

UHF ANTENNA ASSEMBLY, for BC-645 **\$2.45**

CONVERSION BOOKLET, Instructions for most useful surplus rigs. **\$2.50**

DYNAMOTORS

Type	Input	Output	Excellent Used	BRAND NEW
DM-40	14V 3.4A	172V .138A	1.95	3.95
DM-42A	14V 46A	515/1030/2/8 MA 215/260	12.95	16.95
DM-43A	28V 23A	515/1030/2/8 MA 215/260	29.50	
DM-32A	28V 1.1A	250V .05A	2.95	7.50
DM-34D	12V 2.8A	220V .080A	11.95	
DM-35D	12.5V 18.7A	625V .225A	9.95	
DM-36	28V 1.4A	220V .080A	9.95	
DM-37	25.5V 9.2A	625V .225A	12.95	
DM-28	28V	224V .07A	1.95	4.95
DM-53A	28V 1.4A	220V .080A	2.95	6.95
DM-33A	28V 5A	575V .16A	1.95	3.95
	28V 7A	540V .25A		

GOULD 6-VOLT STORAGE BATTERY

15 Amp. Hour Rating. Navy Standard. Black Rubber Case. **BRAND NEW... \$5.95**



WILLARD 6-VOLT MIDGET STORAGE BATTERY

3 Amp. Hour. **BRAND NEW, 35% x 1 13/16" x 2 3/8"**. Uses Standard Electrolyte. **Only \$1.85**

WILLARD 2-VOLT STORAGE BATTERY

20 Amp. Hour. **BRAND NEW, Transparent Plastic Case**. **\$1.95**

1-QUART ELECTROLYTE, enough for two cells. Bottle **\$1.45**

Please include 25% Deposit with order—Balance C.O.D. **MINIMUM ORDER \$3.00.** All Shipments F.O.B. Our Warehouse N.Y.C.

G & G Radio Supply Co.

Dept. N-1

51 Vesey St., New York 7, N. Y., CO 7-4605

by Charles Munch with the Harvard Glee Club and Radcliffe Choral Society; Suzanne Danco, Marguerite; David Poleri, Faust; Martial Singher, Mephistopheles; Donald Gramm, Brander. **RCA Victor LM6114. RIAA curve. Price \$17.85.**

The long awaited modern recording of this great Berlioz score, this is another one of those rarities—a near perfect performance. Munch, having survived the critical attacks that were leveled against him at the beginning of his tenure with the Boston Symphony, has come into his own with his performances of the music of Berlioz. He follows his magnificent achievement in *Romeo and Juliet* with this present recording. He is the guiding spirit who makes possible a unified and cohesive recording of this huge work. His is the sure and knowing hand that holds a tight but firm rein on his soloists and chorus, saving them from the confusion which this work usually engenders. No critical darts can be thrown at the soloists. Danco, Poleri, Singher—each is superb in his role. The chorus of Harvard and Radcliffe are old hands at this sort of thing and their fine singing and assurance contributes greatly to the success of the recording. Soundwise the recording is generally clean and wide range with some great dynamics and tremendous power, especially in the scene where the Demons and Mephistopheles are dancing around Faust. Unreservedly recommended to you. The RIAA curve needed several db bass boost for proper balance. Quiet surfaces.

VIVALDI

FOUR CONCERTI FOR CHAMBER ORCHESTRA

I Musici Chamber Orchestra. Angel 35087. **Price \$5.95.**

The twelve members of the I Musici chamber orchestra are a select group from the Academia Santa Cecilia in Rome. They must have been together a long time to achieve the superb balance and homogeneity of the sound they make in these Vivaldi concerti. Impeccable musicianship seems to be the watchword and their powerful and spirited readings of these works bears this out. Delightful music is enveloped in the richness of ultra-clean wide range sound. A "must" recording for string enthusiasts.

HAROLD SHAPERO

SYMPHONY FOR CLASSICAL ORCHESTRA

Columbia Symphony Orchestra conducted by Leonard Bernstein. Columbia ML4889. **NARTB curve. Price \$5.95.**

This recording has one of my favorite conductors, Leonard Bernstein, performing the kind of music in which he has no peer. His sympathy for the modern idiom is not an accident. It stems from his own writing for this field. As long as we are on the subject of Bernstein, won't somebody please record his very interesting *Jeremiah* symphony? The Shapero work is an odd one, combining as it does, modern form and structure with derivations from the classic writings of Beethoven and others. Don't be afraid of dissonance in this score. It's there all right, but in easy to assimilate doses. All in all, an interesting "off-beat" item which you might like. Good clean sound throughout the disc. **NARTB curve did not need adjustment.**

HOLST

THE PLANETS

London Symphony Orchestra conducted by Sir Malcolm Sargent. London LL1019. **RIAA curve. Price \$5.95.**

This is the third of recent recordings of this work, and I dare say, the final word on the subject. The Boulton-Westminster was a good recording, no doubt about that, but this is generally better in most departments. Between conductors there is little to choose.

Sir Malcolm takes the work at a slightly faster tempo than Boulton and shows more of a tendency to treat the score as a whole rather than as an episodic thing. As good as the sound in the Boulton recording was, this is where this recording really shines. As a hi-fi *tour de force*, it would be hard to beat. Tremendous dynamics are the most striking feature along with silky strings, huge brass sonorities, and percussion which is super-sharp and of impact. Some of the transients in this will floor you! Listen to the conclusion of the "Mars" section. Gadzooks! What a sound!

MOUSSORGSKY

PICTURES AT AN EXHIBITION (PIANO)

LISZT

RHAPSODIE ESPAGNOLE, THREE PAGANINI STUDIES (PIANO)

Alexander Uninsky, piano. Epic LC3066. **NARTB curve. Price \$5.95.**

Uninsky has been making quite a name for himself in this country. When you listen to this disc you begin to understand why. Possessed of a fantastic technical skill, he also knows now to project life and feeling into his work. A perfect example of this is the *Pictures at an Exhibition*. Not since Horowitz have I heard as forceful and vigorous a reading. Add to this excellence of performance a much cleaner, wider range sound than the old Horowitz and you have the record of choice for this work. I can't get too worked up about the Liszt. Interesting as a curiosity and little else. If you want *Pictures* in the original piano version with the best of sound, this is for you.

Jazz Corner

In response to many requests, we will review a few jazz records each month if their quality warrants it. I do not profess to be a jazz expert, so most of the recordings will be reviewed mostly from the standpoint of sound quality.

DYNAMIC DIXIE

Muggsy Spanier and his band. Weathers W5401. **RIAA curve. Price \$5.95.**

This is another one of those special records that Paul Weathers (of pickup fame) puts out. Even a "square" like me knows that Muggsy Spanier is one of the all time greats on the trumpet. Here, with the equally famous George Wettling on drums, and his crew of hand-picked sidemen, Muggsy exhibits his fabulous skill. He doesn't blow into the stratosphere like some of his contemporaries, being mostly a middle register man. But the *power* of this man in that register is unbelievable! When he teams with Wettling and the other boys on something like "When the Saints Come Marchin' In," you know you're hearing Dixie. The sound on this disc is worth the price of admission alone. Recorded with a flock of new techniques developed by Weathers, this is just about the cleanest, most distortion free sound you can imagine. Extremely wide range, with some of the most incredible dynamics and transient response I have ever heard. The staccato blasts of trumpet and trombone, the machine-gun snares and rim shots of Wettling, all are reproduced with the utmost accuracy. As a demonstration disc, this has few equals. **END**

DEMAGNETIZING TIP

By H. L. HENDRICKSON, JR.

A RAPID and efficient method for demagnetizing screw drivers, pliers, or other tools used by the radio and TV service technician around ion traps and loudspeaker magnets is to place the item between the loops of the tip of an energized *Weller* or similar electric soldering gun.

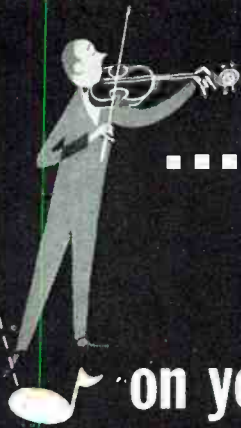

...Get all the "highs"
—and all the "lows"...

on your "hi-fi" equipment!



Check it with an RCA WA-44A AUDIO SIGNAL GENERATOR

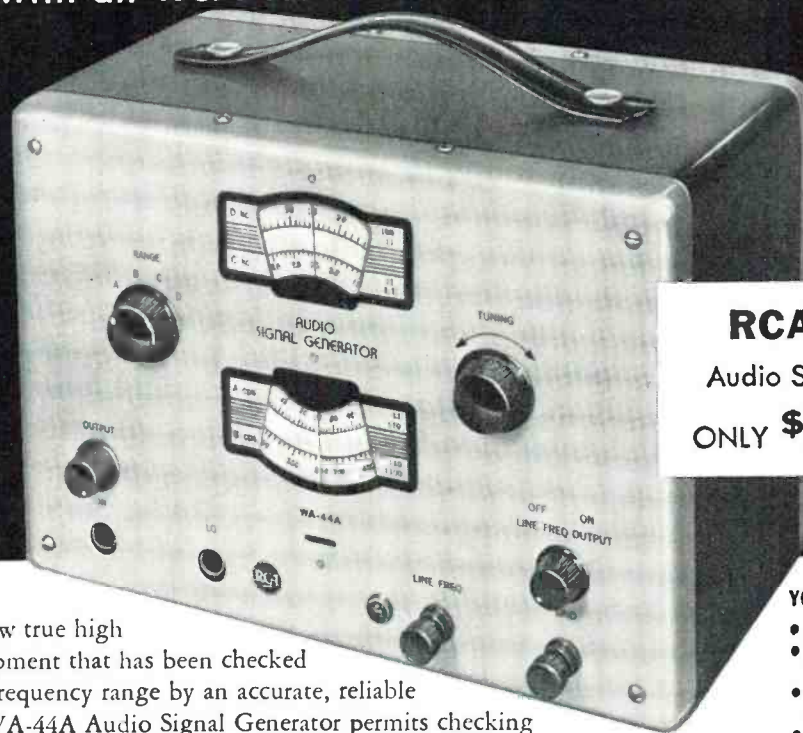

RCA WA-44A

Audio Signal Generator

ONLY **\$87⁵⁰** (SUGGESTED USER PRICE)

Hi-fi enthusiasts know true high fidelity requires equipment that has been checked beyond the audible frequency range by an accurate, reliable instrument. RCA's WA-44A Audio Signal Generator permits checking response of hi-fi amplifiers over the range from 11 cps to 100 kc. Highly stable output flat within ± 1 db over wide ranges of ambient temperature and ac line voltage is insured by a unique delayed agc circuit which controls oscillator output.

A cathode-follower output stage—usually found in more expensive instruments—isolates the sine-wave oscillator from effects of reflected load reactance and resistance. This feature provides excellent output wave-form, a high degree of frequency stability, and good voltage regulation. Two *separate* audio signals are available from the WA-44A: a tuneable audio signal and a 60-cps signal—an essential feature for intermodulation testing.

Small, compact, lightweight and easy-to-use, the WA-44A Audio Signal Generator has many more design and construction features you'll like! Ask your local RCA Distributor for a demonstration and complete details.

YOU NEED THE WA-44A TO MEASURE:

- amplifier frequency response
- intermodulation distortion in amplifiers
- frequency response of tone-control circuits
- frequency response of phonograph equalizers
- input and output impedances of amplifiers
- resonant frequencies of loudspeakers

AND FOR:

- tuning bass-reflex enclosures
- determining unknown audio frequencies
- determining inductance and capacitance
- tracing audio signals
- determining the resonant frequencies of LC circuits
- locating cabinet resonances and rattles



RADIO CORPORATION of AMERICA

TEST EQUIPMENT

HARRISON, N. J.

1930
THE FIRST 4...

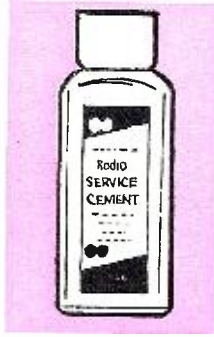

RADIO SERVICE CEMENT

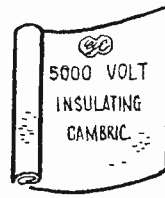

VARNISH CAMBRIC



RADIO SERVICE SOLVENT

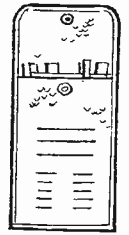

STEEL SPEAKER SHIMS

How 4 Radio Service Products



Radio—
Television

SERVICE AIDS

Just 25 years ago this month, General Cement was little more than a hopeful gleam in its two founders' eyes. Yet such was their determination to bring quality, imagination and utility to the then infant radio service industry that today G-C is one of the best known names in radio—

television—electronics. For this great acceptance, we of G-C are truly grateful and promise to maintain our reputation for manufacturing economically priced, top quality service aids . . . chemicals . . . tools . . . hardware . . . whether it's one item or several thousand!

1930 Production Facilities 850 sq. ft.



1955 Five plants, 150,000 sq. ft.



FOR BETTER TV SERVICE!

Remember the TELCO name for all your television service needs—antennas, antenna mounts, accessories and hardware. Television Hardware Mfg. Co., is a separate G-C division to make sure you get *what you want when you want it!*

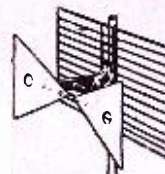

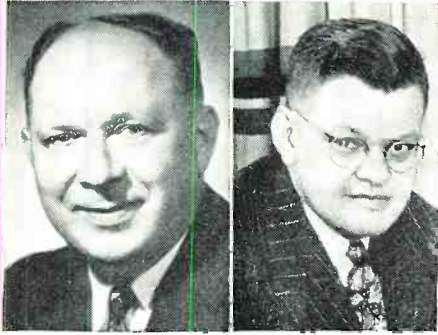

FOUNDERS . . . S. B. Valiulis, President, and R. G. Ellis, Secretary, Treasurer and General Sales Manager, founded G-C (General Cement Mfg. Co.) on January 6, 1930.

Became 4000!



1955
OVER 4,000
G-C SERVICE AIDS

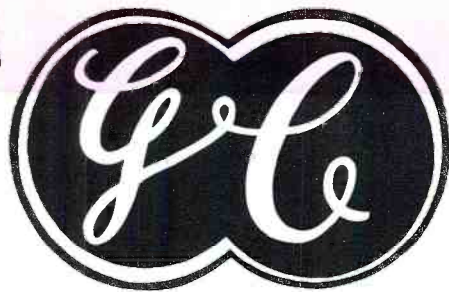

General Cement Mfg. Co.

904 TAYLOR AVENUE • ROCKFORD, ILLINOIS

Plan Now
for the **4** biggest
days
in radio-electronics!

I R E National Convention
and
RADIO ENGINEERING SHOW

March 21-24
New York City

Once again, you'll soon have the opportunity of appraising all of the important new developments of the past year in radio and electronics. In 4 days, from March 21 through 24, the I R E National Convention and Radio Engineering Show will give you the complete picture of significant developments in the industry achieved during the past year.

You'll hear the presentation of scientific and engineering papers of vital interest to you, carefully arranged into related groups of technical sessions.

You'll see more than 700 exhibits in a 4-acre panorama of all that's new in the radio and electronics field, at Kingsbridge Armory and at Kingsbridge Palace.



The Institute
of Radio Engineers
1 East 79th Street,
New York City

RADIO-TV Service Industry News

AS REPORTED BY THE
TELEVISION TECHNICIANS LECTURE BUREAU

AN ALMOST universal weakness in the management of small businesses is the failure to anticipate the known periods of poor business and to make plans to compensate for the serious loss of income that occurs during those periods. This is especially true of businesses that cater to the varying whims of the general public and, in particular, the small shops that specialize in television service.

When television service is good, shop owners are usually hard pressed to find time to handle all of the calls they get. During those periods there is a tendency to let down on sales promotional efforts, to overbuy tubes, parts, and supplies, and to forget about the days sure to come when business will be bad. The normal pattern of television service seems to be a gradual decline in the volume of service calls starting in midspring with a sharp dip occurring with the arrival of hot weather and continuing throughout the summer months.

Broadcasters seem to be resigned to the fact that televiewing will be at a low ebb during the summer months. The quality of summertime programs has not been good so they do not inspire set owners to keep their sets in good operating condition.

The best and most logical time to make both long and short range plans is at the very beginning of the year. The normal local pattern of business should be well known to every service businessman. He should be able to determine from his records when his main line of business usually starts to taper off, and when it hits rock bottom and the length of time it stays there. This is always a critical period for every service business, regardless of size, and it is also the period when the rate of failure among service shops reaches its highest point.

The managers of prewar service businesses cushioned the summertime drop in home set servicing by promoting battery portable and auto radio service during the late spring and summer months. Also, in those days, new cars did not come equipped with radio sets from the factory. Alert radio technicians did well by handling radio installations for new car dealers. Those activities provided the summer-

time cushion in service volume, for this type of work peaked up to maximum when home radio service was at a minimum.

Technicians who have come into the business since the advent of TV are inclined to look disdainfully on servicing radio sets. This same attitude applies to automatic record players largely because electronic technicians do not like to repair mechanical devices. As a result of the neglect in widely promoting service on these two important consumer products, there is a tremendous volume of dormant service work available "just for the asking." To prove this, make a house-to-house canvass of any residential area in a community and inquire at each home whether they have either radio sets or record players that need repairs. The canvasser will find at least one radio set per home that the owner would like to have serviced and an average of one record player every third home. It will add up to an amazing volume of service work in any average residential section.

In planning for the year ahead carefully consider these three important factors:

1. When does the winter volume of service calls start to taper off?
2. When does the summertime slump normally start?
3. When does the fall upswing usually begin?

Also, there are two elements that could greatly influence the seasonal volume of service work in the year ahead. One is the number of long-range events scheduled for the summer that could inspire more televiewing than usual. Interest in the 1952 presidential campaign, for instance, stimulated a summertime boom in service that started early in July and continued through the inauguration in January.

The second unknown is color television sales. They may progress far enough to need a large number of independent service businesses to handle installation and maintenance.

There are no long-range programs of national interest in sight for the summertime ahead, and it is expected that color television will make steady but slow progress during the year.

RADIO & TELEVISION NEWS

Current estimates are that anywhere from 150,000 to 400,000 color television sets will be produced during 1955 with list prices holding at \$800 or above for large screen sets.

Manufacturers and set distributors will hold a close rein on the placement of installation and servicing contracts. Color TV circuitry and components will be constantly changed as field service reports indicate faults and as experience indicates the weaknesses of the sets in consumers' hands and under all climatic conditions.

It is extremely doubtful whether color TV will add any appreciable volume for independent service businesses during the year. Such added business may materialize when volume production and sales are achieved. It is now expected that this will occur in 1956, particularly under the stimulus of re-reporting a presidential campaign in color.

In the light of these facts about the business potentials in the year ahead it is evident that television service businesses should plan now to add and promote some type of seasonal activity that will take up the slack when TV service calls start falling off in the spring and through the three months of normal summertime slump.

Radio Servicing

There is always a sharp upswing in auto radio service when warm weather sends families on picnics and sightseeing jaunts. However, highly efficient servicing companies have been built to handle auto radio servicing and it is hard to break into the business as a purely seasonal activity.

This type of electronic servicing requires specialized skills, facilities, and sales "know how" to be really successful. The shops that specialize in it have a plant and service layout that permits the handling of cars and the removal and re-installation of radios in a minimum of time. They use promotional plans geared to the needs of their areas to maintain a consistent volume of c.o.d. business. The owner maintains contact with auto dealers to get their warranty referrals and out-of-warranty radio work. Shops that do not have special facilities for handling auto radio service and do only an occasional job usually lose money in trying to handle this business.

Auto radio service should be added to a TV service business only after a careful study of the local situation indicates that such a service is needed in the section where the TV shop is located. If a survey indicates that, with proper promotion, sufficient business of this kind to support a department could be obtained, drive ins, benches, booths, and servicing gear should be set up to handle the work with maximum efficiency. It should be conducted as a distinct business in itself with advertising, sales promotion, and service solicitation programs carefully planned to keep a consistent volume of business moving into the shop.

NEW SURPLUS AT NEW LOW PRICES

THOUSANDS! CRYSTALS THOUSANDS!

FT-241 54th Harmonic Type. Fundamentals Frequencies listed below in KC

370	390	410	430	449	469	486	508	
372	392	412	432	451	470	488	510	
374	394	414	434	453	471	490	512	
376	396	416	436	454	472	491	513	
378	398	418	438	456	475	494	516	
380	399	420	440	458	477	496	518	
382	400	422	442	459	478	497	519	
384	402	424	444	462	480	502	520	
386	404	426	446	464	482	504	522	
388	406	428	447	466	484	506	524	
Each Frequency.....							25c; 6 For \$1.00	
500 KC.....								1.25

HEAD SETS
High Impedance R.P. Phones 8000 Ohm. For all standard Radio Output Circuits.....\$2.50 Ea.
All New.....

MICA CAPACITORS FIG. A UPRIGHT MOUNTINGS

MFD.	MFD.	MFD.
1000 V. 75c Ea.	2500 v. \$1.00 Ea.	.00006 \$1.50 Ea.
.1.....	.025.....	.00005.....
.07.....	.00075.....	.00004.....
.05.....	.00025.....	.00015.....
1500 V. 3000 V.	3000 V.	3000 V.
.075.....	.006.....	.001.....
.05.....	.003.....	.0008.....
.03.....	.002.....	.00075.....
2000 V.	3000 V.	.0005.....
.03.....	.000625.....	.00045.....
.01.....	.0005.....	.0002.....
.006.....	.0005.....	.0009.....
.005.....	.0004.....	.0005.....
.003.....	.0003.....	.0004.....
.00275.....	.0001.....	.01.....
.0025.....	.00009.....	.0006.....
.00125.....	.00008.....	.0005.....
.00003.....	.000075.....	.00025.....

LOW PRICE SPECIAL 50¢ Ea.

FIELD TELEPHONES
EE-8 Type, Uses 2 1 1/2 V. Flashlight Batteries for Power. Operates from 10 miles. with Magneto Ringer. In Leather Case. In excellent Condition.....\$27.50 Per Pair

12 V. DC. POWER SUPPLY
This unit operates from 110 V. AC to provide 12 V. DC. @ 4 Amp. Uses Selenium Rectifier and Transformer. Has 4 Amp. overload Circuit Breaker. Excc. Condition.....\$9.95 Ea.

6 V. DC. DYNAMOTOR
For Mobile Use. Operates from 110 V. AC. To provide 250 V. @ 50 M.A. Dynamotor enclosed in metal case. Used. Good Cond.....\$7.95 Ea.

ARMY AMMUNITION CANS
Type M-3 50 Cal. Cans 12" Long x 6" Wide x 7 1/2" Deep.
Type M-4 Cans 16 1/2" Long x 3 1/2" Wide x 6 1/2" Deep.
All aluminum with Leather Handle and Hinged Top with hasp. Use for all your small parts or tools. O.D. Color, clean inside and buff or paint.....Each \$1.50

RADIO DIRECTION FINDER
BC-1003 Receiver. Frequency Range 100 KC-1000 KC in 3 bands. Has Loops mounted on top with Sense and Balance Circuits, Less power supply. In Excc. Cond. with Tubes.....\$49.95 Ea.
12 V. Input Dyn. for above Receiver \$6.95 Ea.

SPECIAL A.C. MOTORS
1/40 Horse Power. Bodine Synch. Motor. 1800 R.P.M. Operates on 110 V., 60 Cy. Has 2 shafts and fan type flange mount. Uses 5 Mfd. capacitor for starting. Used for Fan, or small Grinder, Buffer or Hobby work. All in excellent condition.....\$7.95 Ea.
Capacitor.....Ea. \$1.00

MIDGET SELSYNS
AY6 type operates from 6-12 Volt 60 Cycle. Use as both transmitter and receiver. These compact little units draw almost no current and work fine for all remote position indicating applications. OD 2 1/2 x 3 1/4 x 2 1/2". Has spring return shaft. All New (Apr. wt. 1 lb.).....Each \$1.95

SELSYN MOTORS
Type 5F Synchro Motors. used in pairs for remote tuning or remote position indicators. 115 V., 60 Cy. operation. Size 3 1/4" Diam. x 2 1/2" long. Like New.....\$35.00 Pair

BC 375 TUNING UNITS
TU-3 (200-500 KC), TU-10 (10,000-12,500 KC), TU-8 (6200-7700 KC), TU-9 (7700-10000 KC), All with Vernier Dials, and Many useful parts. All used.....Low Price @ \$1.50 Ea.

POLE CLIMBERS AND BELTS
Telephone Type Climbers with Leather Leg Straps. Used, Excellent Cond.....Pair \$2.95 Ea.
Safety Tool Belts, Leather, to use with pole climbers. Used, Excellent Cond.....\$3.50 Ea.

12 or 24 VOLT VIBRATOR INVERTER
Use for Mobile Radio, Trucks, Buses, etc., where 110 Volt, 60 Cycle is desired. Can be used on 12 Volts or 24 Volts D.C. input, 110 V., 60 cycle, 240 watt maximum output. Uses separate vibrator for each input voltage. In enclosed case.....\$27.50 Ea.
12 Volt 68 Amp. Hour Battery—New.....\$14.95

PARTS BOXES
Durable, Strong Wood Boxes with 2 drawers. Corners are iron bound. Will make an ideal box for storing small resistors, capacitors, fuses, or any small parts or tools. Box dimensions 10 1/2" W. x 17 1/2" L. x 9" H. Drawers are 9 1/2" W. x 16 1/4" L. x 2 3/4" H. Hinged cover and carrying handle. All New.....\$2.95 Ea.

LOW VOLTAGE CIRCUIT TESTERS
These Testers made for checking complete ignition systems in 6 or 12 Volt cars or trucks. Generator, Regulator, Battery, etc. Can be checked individually or together while engine is running or still. These units are all in excellent condition. Low Priced.....\$17.95 Ea.

WILLARD 2 VOLT RADIO BATTERY
NEW. Dry Charged (Apr. wt. 4 lbs.) TYPE 20-2 20 Amp. Hour Ea. \$2.95
2 VOLT VIBRATORS. VBSA Synchronous Type. Used in all portable receiving 2 volt wet cell supply. All new Ea. \$4.00

All Mail Orders Promptly Filled, F.O.B., San Francisco. All California Orders—Add 3% Sales Tax. Do not send postage stamps. 20% Dep. on all C.O.D. orders. All items subject to prior sale and prices subject to change without notice. On purchases under \$5.00 send full amount.

STANDARD SURPLUS 1230 Market St., San Francisco 3, Cal. Telephone HEmlock 1-3106

now you can really understand **COLOR TV!**

get the new SAMS book

"Fundamentals of Color Television" by **BOYCE**

written so you can UNDERSTAND it

ONLY \$2.00

all you want to know in five great chapters:

CHAPT. 1: "What You Need to Know About Color." A simple description of color, its relationship to the eye, its application in Color TV; explains terms: hue, saturation, mixtures, purity, chromatic, achromatic, luminosity, etc.

CHAPT. 2: "Color Picture Reproduction." Covers physical aspect of color reproduction in the picture tube; tube structures and exact physical functioning in all major color tube types.

CHAPT. 3: "Principles of NTSC Color System." Complete description of Color TV signal; compatibility requirements; integration of color and sound; methods of transmission and reception.

CHAPT. 4: "Color Receivers." Covers theory of operation of various receiver systems using any of the color picture tubes, in block diagram analysis form.

CHAPT. 5: "Circuit Analysis of Color Receivers." Covers every circuit in detail; gives practical information on special components associated with color; all text supported by photos, block diagrams and schematics.

Prepare for Color TV with the help of this complete, easy-to-understand up-to-date book. 224 pages. 5 1/2 x 8 1/2".

ORDER BA-1 \$2.00 Only

ORDER TODAY

HOWARD W. SAMS & CO., INC.

Order from your Parts Jobber today, or write to Howard W. Sams & Co., Inc. 2203 East 46th St., Indianapolis 5, Ind.

My (check) (money order) for \$..... enclosed. Send.....copy(ies) of "Fundamentals of Color Television" (BA-1, \$2.00)

Name.....

Address.....

City.....Zone.....State..... (outside U.S.A. priced slightly higher)

AM radio is still the universal contact for spot news of current events and the "old reliable" that permits the listener to do other work while enjoying a story or a musical program. Most homes have at least two operating radio sets and many have a set in every room. Practically every radio over two years old needs some type of maintenance even though the set is used constantly. Badly worn volume controls that make proper adjustment of volume difficult and leaky capacitors are common in a high percentage of the sets in daily use.

Any service shop operator can give his business a good shot in the arm at any time with a special promotion of AM radio service. This type of promotion is neither expensive nor difficult to do and yet, if properly planned and handled, will keep a shop well supplied with business any season of the year.

As an illustration of what can be accomplished, take a community service shop located in an area where five to ten thousand homes could be easily reached with handbills. A special offer is developed to service any 5-tube table model AM radio for \$1.75 plus the cost of tubes and parts necessary to service it. Copy for the handbill should be prepared which will feature this special, limited time offer for \$1.75, and include a list of the free services that will be included, such as cleaning the cabinet, exhausting all dust, examination of the speaker and all circuits, estimate of the total cost before the set is serviced, and the return of all replaced parts and tubes with the set.

The handbills should be distributed house-to-house at the rate of five hundred or so per day. A high school student can be employed to make this house-to-house distribution. It is a good idea to plan a series of handbills about this special offer. After the selected area is covered at the rate of about 500 per day, a second handbill should be delivered on the pattern of distribution followed in putting out the first one. Distribution of the third handbill in the series should be started as soon as the circulation of number two is completed.

An alternative to distributing handbills house-to-house is to use the new "Postal Patron" delivery service that the post office department now provides. To use this service, the special offer should be made up on a suitable mailing card. No name or address is necessary for the person who is to get the mailing piece. The designation "Postal Patron" printed as the addressee plus whatever local designation your local post office requires, will insure the delivery of one of these cards in the mailbox at every home in the area you select for coverage. Complete information about how this service can be used in your city can be obtained from your local postmaster.

This is dynamic service selling because it makes the home owner think about service of his radios. People

QUARTZ CRYSTALS

FT-243-.093" PIN DIA.—.486" PIN SPC

FOR HAM AND GENERAL USE • GUARANTEED

4035 5675 5940 6673 7473 7675 7925	1015 6473 7100 8075 8525
4080 5700 5950 6675 7475 7700 7940	3735 6475 7125 8100 8550
4165 5706 5973 6700 7500 7706 7950	3940 6500 7150 8125 8575
4190 5725 6240 6706 7506 7725 7973	3990 6506 7173 8150 8600
4280 5740 6250 6725 7525 7740 7975	6000 6550 7250 8173 8625
4300 5750 6273 6750 7540 7750 8225	6025 6573 7300 8175 8650
4397 5773 6275 6775 7550 7773 8250	6050 6575 7306 8200 8700
4490 5806 6300 6800 7573 7775 8273	6075 6600 7325 8340 8733
4495 5840 6325 6825 7575 7800 8275	6100 6606 7340 8350
4930 5850 6340 6850 7600 7825 8300	6125 6625 7350 8375
5030 5852 6350 6875 7606 7840 8325	6140 6640 7375 8380
5205 5873 6373 6900 7625 7850 8630	6150 6650 7400 8400
5300 5875 6375 6925 7640 7873	6175 7000 7425 8425
5385 5880 6400 6950 7641 7875	6200 7025 7440 8450
5485 5906 6406 6975 7650 7900	6440 7050 8025 8475
5500 5925 6425 7450 7673 7906	6450 7075 8050 8500

49c each—10 for \$4.00

99c ea. 10 for \$8.00

Low Frequency—FT-241A for SSB, Lattice Filter etc., .093" Pins, .486" SPC, marked in Channel Nos. 0 to 79, 54th Harmonic and 270 to 389, 72nd Harmonic. Listed below by Fundamental Frequencies, fractions omitted.	CR 14-1	FT1718 BC-610 2 Banana Plugs 3/4" SPC
370 393 414 437 501 522 400 461 5910	14-1	2030 2220 2360 3202 2945
372 394 415 438 502 523 440 462 6370	14-1	2045 2258 2390 3215 3955
374 395 416 481 503 525 441 463 6450	14-1	2065 2260 2415 3237 3995
375 396 418 483 504 526 442 464 6470	14-1	2082 2282 2435 3250
376 397 419 484 505 527 444 465 6497	14-1	2105 2290 2442 3262
377 398 420 485 506 529 445 466 6522	14-1	2125 2300 2532 3510
379 401 422 486 507 530 446 468 6547	14-1	2145 2305 2545 3520
380 402 423 487 508 531 447 469 6610	14-1	2155 2320 2557 3550
381 403 424 488 509 533 448 470 7380	14-1	99c each — 10 for \$8.00
383 404 425 490 511 534 450 472 7380	14-1	
384 405 426 491 512 536 451 473 7390	14-1	
385 406 427 492 513 537 452 474 7480	14-1	
386 407 429 493 514 538 453 475 7580	14-1	
387 408 430 494 515 454 476 7810	14-1	
388 409 431 495 516 455 477 7930	14-1	
390 411 433 496 518 457 479	14-1	
391 412 435 497 519 458 480	14-1	
392 413 436 498 520 459	14-1	

49c each—10 for \$4.00

99c ea. 10 for \$8

TG 34A Code Keyer

Automatic Code Practice Sending and Keying Oscillator, 1.5 or 230 V. @ 50-60 cycles. Portable. Built-in speaker-amp. Variable speed from 5 to 25 w.p.m. Uses inked tapes. Brand New. \$19.95 Set of 3 different tapes \$3.75

Spec.—200 KC or 500 KC in FT241A Holder. \$1.79 ea.

- Add 20¢ postage for every 10 crystals or less.
- Indicate second choice; subst. may be necessary.



520 TENTH ST. N. W.—WASH. D. C., DEPT. N



ACRO TO-300 Ultra Linear Williamson Transformer

The FINEST Audio Output Transformer in the World! 40 Watts undistorted power: 30 cps to 30 kc. Frequency Response: +1 db. 10 cps to 100 kc. For use with 5881's, KT 66's or 807's. Shipping weight: 7 lbs. NET \$24.75

ACRO TO-330: For push-pull parallel ultra-linear operation using 4 5881's, KT 66's or 807's to deliver a peak output of 60 watts. Shipping weight: 17 lbs. NET \$39.75

ACRO TO-310: Used when remodeling 6V6 amplifier to ultra-linear operation. Shipping weight: 6 lbs. NET \$18.75



FREE! 160 page High Fidelity catalog.

Contains over 500 items related to High Fidelity . . . plus . . . construction plans for constructing your own baffle. Write for your copy today.

MAIL ORDERS ACCEPTED 25% deposit, balance C.O.D. 24 hour service

LEONARD RADIO, INC. AUDIO MART 69 Castlere St., New York 7, N.Y. COrlford 7.0315

RADIO & TELEVISION NEWS

are inclined to procrastinate in buying service. This is especially true about radio sets where there are several in use in the home. A radio set quits playing. The owner sets it back in a closet with the best intentions of looking up a service shop to have it repaired. It is apt to stay there unless some service technician jogs his memory and makes it easy for him to have it fixed. This type of promotion sells service because it makes it easy for the customer to buy it.

Other Business Sources

A competent record changer technician with a flair for selling can always have a field day for business when he solicits service work of this kind. Most people are proud of their record players but neglect the normal maintenance that these instruments should have. Take needles, for instance. There are many needle kits and demonstrating aids to let a customer hear the difference in reproduction of a new, modern needle over the old one in his record changer. There is a nice profit in needle sales and in associated player service work.

Countless thousands of automatic record changers are not used because the cycling mechanism is out of adjustment. When this type of service work is aggressively promoted it adds appreciable volume to the shop's service income. It can be promoted just as effectively in the summer as during other seasons of the year.

A good source of seasonal business, particularly to fill in during the period when TV service calls are gradually tapering off, is that of battery portables and the sale of the "A" and "B" batteries they need.

Battery portables are usually stored away in the winter and forgotten until the warm spring days make picnics inviting. One way to promote this type of business is to have a good sized card made up to publicize the service you can give on these types of radios. Leave one with each TV service customer. You could offer to pick up the portable, check and clean it, refit it with batteries, and keep it for them until they are ready for it. Where no immediate time element is involved to have the set fixed, portables can be handled in the shop when time permits.

Another badly neglected category of electronic products widely used in homes and small businesses are tape and wire recorders. Most owners do not know where to go to have them repaired except back to the dealer from whom they were purchased. Since most dealers do not have the personnel or facilities to service recorders, customers get bounced around in having the work done.

While many television service companies have the know how and facilities for repairing recorders, owners normally do not associate electronic recorders with television sets. Consequently they are inclined to call on some other type of service business for recorder repairs.

PROGRESSIVE SPEAKER EXPANSION

a new approach to personalized listening ...

by *University*

A modest budget need no longer limit the quality and caliber of your hi-fi aspirations. University offers, for the first time in audio history, a tremendous selection of uniquely designed speaker and network components so brilliantly conceived and executed that it is now possible to develop your loudspeaker system in successive, relatively inexpensive stages ... until what you have meets your listening requirements.

Progressive Speaker Expansion by University makes it possible for you to buy a speaker today in terms of the system you want tomorrow! You are thus able to devote your present budget primarily in the initial selection of quality amplifying and program source equipment which cannot be economically altered or substituted at a later date. P-S-E makes your speaker choice an easy one. Depending upon your goal and space limitations, there are numerous University speaker systems that can be started at minimum cost with immediate listening satisfaction.

start planning today ...
the *University* way!

- Buy good amplifier and program source equipment which will do justice to your eventual University speaker system ... and start with one of the versatile top quality speakers or combinations recommended in the P-S-E chart.*
- Build up to a deluxe speaker system with University components so designed that speaker and network can be easily integrated for better and better sound reproduction—without fear of obsolescence.
- Own a P-S-E speaker system which meets hi-fi quality standards from the very beginning—and reach the highest standard of all—YOUR OWN.

Do it with University P-S-E! Only University products can meet such flexibility of application and demanding performance requirements.

University Loudspeakers

INC.

80 SOUTH KENSICO AVENUE, WHITE PLAINS, NEW YORK

*For the complete illustrated Progressive Speaker Expansion charts, write Desk No. 40, University Loudspeakers, Inc., White Plains, New York

RECEIVING TUBES

EXTRA SPECIAL!!
C.B.S. HYTRON

10BP4 11.95
12LP4 12.95

OTHER TUBES AVAILABLE AT SAME LOW, LOW PRICES

Send for FREE catalog of additional tubes and parts

STUART ELECTRONICS DISTRIBUTORS

Dept. R-1 Minimum Order \$10.00
TERMS: 25% Check or Money Order, Balance C.O.D., F.O.B. New York. Satisfaction Guaranteed or money back in 10 days.

THREE TOP BRANDS ONLY!

AT TREMENDOUS SAVINGS OVER REGULAR WHOLESALE

Check These BIG BARGAIN Prices
Brand New Pix Tubes Full One Year Guarantee
DU MONT AND R.C.A. LICENSED

	With Old Tube	With New Tube
10BP4	11.50	11.20
12LP4	12.95	11.95
12LP4A	14.50	11.95
12CP4	12.95	11.95
14CP4	14.95	13.95
15AP4	15.95	14.95
16AP4	20.95	17.95
16CP4A	19.45	15.95
16DP4A	17.95	15.95
16EP4A	20.95	17.95
16FP4	17.45	15.95
16GP4	20.95	17.95
16RP4	18.95	15.95
17BP4	19.95	16.95
17CP4	20.95	18.95
19AP4A	23.95	20.95
20CP4	25.95	19.95
20HP4	26.95	20.95
21EP4	26.95	20.95
21AP4	28.95	23.95
21FP4	27.95	21.95
24P4	59.95	44.95

149-09 Union Turnpike Flushing 67, N. Y. Olympia 8-3553, 4352

Color's bigger than ever! AND THE NEW 2ND EDITION OF

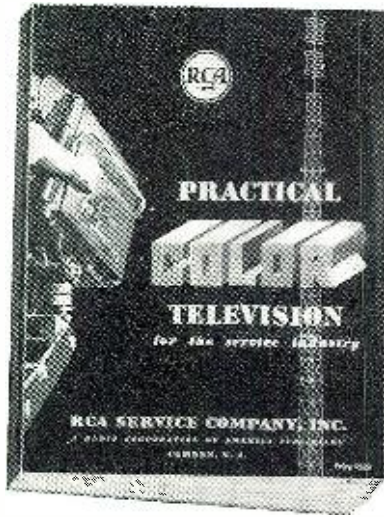

IS MORE THAN EVER A MUST

Color television receivers at much better prices are due to hit dealers' floors any time now. And when color television starts moving in volume . . . every technician must be ready for this new, different, profitable field. There's not a day to lose. Get your copy of the brand new 2nd edition of *PRACTICAL COLOR TELEVISION* . . . and get it right away!

Here is the latest *practical* color service information you can get from any source. Included in its 86 pages are: Principles of Color Television . . . Detailed Circuit Diagrams . . . Operating Instructions . . . Antenna Requirements . . . Test Recommendations . . . and much, much more. Time-tested information . . . brought up to the minute by RCA, pioneer in compatible color television.

\$2.00 a copy . . . and worth far more in future color television profits for you! See your RCA Parts and Tube Distributor, or mail the coupon . . . today.

RCA SERVICE COMPANY, INC.

A Radio Corporation of America Subsidiary
CAMDEN, NEW JERSEY

RCA Service Co., Inc.
Commercial Service Section
Camden, N. J.



Please send me _____ copies of "Practical Color Television" at \$2.00 each.

Check or Money Order for \$_____ enclosed.

NAME _____

COMPANY _____

STREET _____

CITY _____

ZONE _____

STATE _____

The growing number of electronic devices that are being sold for use in the home will some day bring about the development of one-stop electronic service companies to provide maintenance and service on all of these electronic devices in the home.

In some areas, distributors are already carrying this idea one step further by having their authorized television service shops provide installation and maintenance on room air conditioners and major appliances.

Major television service companies have the same problem of maintaining seasonal service volume as the small, one-man shops—and on a much bigger scale. The serious drop in TV service calls during the summer months poses a very serious problem to the large service company in maintaining its staff of technicians and other trained personnel.

The booming sales of room air conditioners thrust an opportunity into the laps of the large service organizations which many of them seized immediately. Sales of these units peak during the season when TV service volume is at its lowest point. The requirement for efficient handling of the installation and servicing of conditioners is the same as that for TV servicing: trucks, personnel, "know how," and an effective service control system.

The installation of room air conditioners is not a type of business that can be handled profitably or efficiently by a small service business. It is a fast-moving business and the installation organization must be prepared to move swiftly when a sudden heat wave brings a surge of sales. It will, however, become an increasingly important element in the activities of major TV service companies.

Many operators of small and medium sized shops have solved their basic overhead problem by providing needed nonelectronic services in the communities where they are located. As an example, several shops located on streets that have good pedestrian traffic have turned the front sections of their shops into attractive greeting card centers. The systems used by several of the large greeting card manufacturers to keep their regular outlets supplied with an adequate stock of seasonal and nonseasonal cards makes it easy to operate that kind of a center without giving a lot of time to buying and seeking out sources of supply. In other sections service shops pay their basic overhead expenses with key making machines or as flashlight and traffic appliance service centers.

Every city and town offers some sort of an opportunity for the service technician to couple with his TV or radio service work to level off his monthly income. There is always a tremendous dormant market for electronic service of some kind at every season of the year that the alert, business-minded technician can promote for the benefit of his own business.

REPEAT SALE BY POPULAR DEMAND

WORLD-FAMOUS HI-FI 3-SPEED AUTOMATIC PHONO 3 SPEAKERS

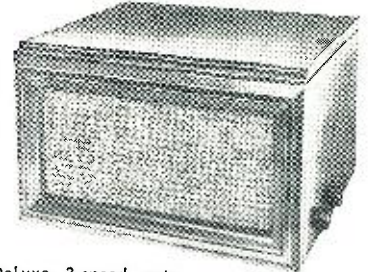

Deluxe 3-speed automatic record player with speaker cross over network for true high-fidelity. 4 tube amplifier scientifically designed to reproduce from 20 to 20,000 cycles. Automatic shut-off for amplifier when last record has played. Beautiful mahogany cabinet with luxurious woven grill. Dimensions: 17³/₈" x 15⁷/₈" x 11". Weight 30 lbs.

Nationally
Advertised
for \$139.95

CLOSE OUT
PRICE!

\$72⁵⁰

Write Dept. RN-1 for FREE catalog.

STEVE-EL Electronics Corp.
61 Reade St. New York 7, N. Y.

New Guaranteed **TUBES** Standard Brands

PRICES SLASHED FAR BELOW WHOLESALE!

Standard brands only! One of largest stocks in U.S. We sell—buy—trade. WRITE FOR PRICES ON ANY TUBES NOT LISTED.

1A7GT60	6J8G90	12SR750
1LC680	6K750	25L6GT50
1LN580	6L6	1.00	25Z550
1N5GT60	6L785	1N21B	1.90
1R560	6N785	1N23B	1.90
1X2A90	6S450	1N26	4.95
3A470	6SF785	1N34A69
3D650	6S6765	1N6959
3Q450	6SH750	2D21	1.00
3Q5GT70	6SJ750	2E26	3.00
3S450	6SK755	3FP7	1.25
5U4G70	6SL7GT65	3GP1	1.25
5V4G80	6SN7GT85	4-125A	19.00
5Y3GT40	6T880	4-400A	39.50
6AB750	6V6GT60	4X150A	27.50
6AC780			5AP1	2.25
6AG560			813	9.50
6AG7	1.00			829	6.50
6AK550			832A	6.50
6AL570			86595
6AQ550			872A	1.75
6AL7GT	1.25			92275
6AT640	6W4GT55	923	1.30
6AU660	7C775	927	1.50
6AV5GT85	12A665	931A	3.75
6AG7	1.00	12AH790	95430
6B4G60	12AT785	95540
6B4G60	12AU785	95540
6B6GG	1.60	12AX465	95740
6C450	12AY7	1.20	959	1.30
6CD6G	1.60	12C865	162529
6F680	12H650	2050	1.10
6F7	1.00	12J5GT50	205185
6F8G60	12SC780	9001	1.00
6G6G85	12SH775	900275
6H650	12SL7GT85	9003	1.10

Klystrons
Magnetrons
All Types

SPECIALS!		STANDARD BRANDS ONLY	
3B24	3.25	814	2.75
5BP4	2.00	866A	1.00
701A	2.25	958A40

Ask for items not listed—we have them. Prices subject to change without notice. Californians add sales tax. Add postage to order. Minim. order \$5.00.



ELECTRONICS
Dept. R-L
7552 Melrose Ave.
Los Angeles 46,
California

Low-Pass Filter

(Continued from page 61)

monly used for grid swamping in TV transmitter service. These resistors have excellent characteristics, and with suitable series-parallel connection, our tests were run.

From these measurements, we would conservatively estimate that the filter should handle the r.f. output from a half kilowatt transmitter. On test we ran our push-pull 24G final on 14 mc., with 250 watts input, and measured power output of 165 to 170 watts through the filter, with key-down conditions for an hour. At the end of this time, the filter was opened and the coils were felt for any temperature rise; they were found to be barely warm to the touch, indicating rather low losses. It thus appears that the filter should be able to handle all but the largest of rigs.

Those interested in running a California kilowatt to their ham transmitters are directed to an excellent article by Mack Seybold, W2RYI, in the January-March 1953 issue of "RCA Ham Tips," wherein instructions may be found for heavy-duty coils. —30—

RADIO SERVICE HINT

By L. H. WILSON

ALWAYS carry a 6-inch stainless steel ruler in my pocket for use in measuring mounting hole centers, etc. It is very handy also for another use which may not have occurred to many service technicians who habitually carry a similar ruler with them.

This ruler is about twenty thousandths of an inch thick which is just about the spacing between rotor and stator plates on AM radio receiver tuning capacitors. When I am aligning one of these sets, I simply stick the ruler between the leaves of the oscillator section of the tuning capacitor and kill the oscillator to prevent the whistles and station noises which otherwise would be coming through to interfere with my alignment of the i.f. stages. —30—

LOW-COST SHOCK MOUNTS

You can use ordinary rubber vacuum cups, available at hardware, dime, and automotive supply stores, as shock mounts for your mobile radio gear.

Use the larger sizes for transmitters, power supplies, and heavier equipment, and the small sizes for receivers, pre-amplifiers, and sub-assemblies. —30—

Vacuum cups used as shock mounts for gear.

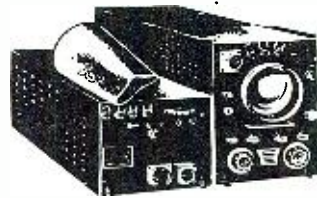
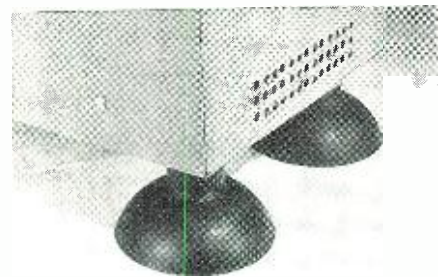

Marine or Airborne Long Range Navigational equipment! Determine the exact geographic position of your boat or airplane!
AN/APN4 Loran set. Frequency range 1700-2000 KC. complete with 1MB/APN4 indicator, R9B/APN4 receiver, crystal and plugs.
Complete.....Brand New **\$129.50**

R-65/APN-9 LORAN Indicator. LATEST MODEL UNIT. Complete in one light weight case. Accurate on a maximum range of up to 1600 statute miles, within 1% of the distance from the ground transmitter. The finest unit available at any price!
BRAND NEW. Only..... **\$295.00**

ID-6A/APN-4 LORAN Indicator. Uses 5CP1 Cathode Ray Tube. Easily converted to test oscilloscope, pan-adaptor, analyzer, visual counter, etc. Contains extremely accurate 100 KC crystal to time sweeps and marker pips at 2, 20, and 100 KC or 50, 500, and 2500 microseconds. Two parallel sweeps, time differences between signals, between half power points on passband curves, and numerous other scope uses. Use the counter circuits for FM demodulation, or to time camera shutters, etc. Double deck chassis, 5CP1 mounted in full tube shield, lots of detail sockets (used 25 tubes). Less small tubes. COMPLETE with 5CP1 Crystal and schematic in cabinet 19 1/2"x9"x11 1/4". BRAND NEW!
While they last..... **\$18.95**

160 METER RECEIVER
High Voltage Power Supply; can be easily converted for 110 VAC. 60 cycle operation, complete with instructions, brand new, less tubes...ea. **\$9.95**
100 KC crystal NEW..... **\$4.95 Ea.**
AT4 ARN-1 ANTENNA—Brand New. Exc..... **\$9.95**
MOTOROLA REC., XMTR., and POWER SUPPLY. Type T-69-20, 30 to 40 Mc, AM, 6VDC. Used, good, less tubes..... **\$29.50**

RL-42 BEAM ROTATOR—Used, good.....ea. **\$1.95** ea. 3 for **\$4.25**
3" DUAL SCALE PANEL METER—0-1 KV **\$2.95** and 0-10MA **\$2.95**
CORDS FOR BC669 CD-513 and 513.....ea. **\$2.50**

SURPRISE PACKAGE
20 lbs. of MISCELLANEOUS ELECTRONIC EQUIPMENT—WORTH MUCH MORE THAN this low price of ONLY..... **\$1.95**

RELAY
Time delay: SPST, supply: 0 (normally open) oil dash pot type; coil 110V—50-60 cps, operates from 0-20. Sec. cont. 3 amp, 550 V continuous. Impregnated for high humidity.
New..... **\$1.95**

OIL CONDENSERS—8 mfd @ 600 VDC.....ea. **\$0.98**
2 @ 4000.....ea. **.98**
2 @ 4000 V.....ea. **.98**
10 for..... **8.95**

TUBES—10 ASSORTED FOR \$3.00

6H6	957	1F5	6H6
7193	955	1625	1632
125J7	9006	1626	1633
154	9002	1629	9001
12A6	6AG5	6FB	6C4
801	211	801A	9004
954	1F4		

SPECIAL TUBES

5R4GY.....	95c	371B.....	95c
6L6 (1614).....	95c	720BY.....	\$9.95
VR150.....	95c	307A.....	95c

6AC7..... **69c**

TUBE BARGAIN

5AP1	4AP10	} \$1.95 each
5BP1	5FP7	
3FP7	3CP1	} 4 for \$7.00
5CP1, New		

.....ea. **\$4.95**

VHF RECEIVER
6 tubes: 3-6SL7, 1-6SN7, 1-6SG7, 1-6X3. Dynamotor, plug-in coils and sensitive relays. This was one of the Army's "Secret" V.H.F. remote control receivers, operating at about 110 MC. A thousand and one uses. New in a metal case. **\$5.95**
Each..... **\$1.59**
WIRE—Cotton covered, No. 22, solid enameled 1000 ft. **\$9.95**
12 V. DYNAMOTOR—Output 440 V, 400 MA, EXCELLENT **\$9.95**
BC-347 INTER-PHONE—Amp, used, 95c; less tubes.....3 for **\$2.00**

1-70 "65" METER—New..... **89c**
BC 1267 Transmitter & Receiver—154-186 mcs. 1 kw pulse oscillator superhet circuit. Can be easily converted to 2 meter converter and outboard amplifier. Used, exc. cond.ea. **\$14.95**
RA-105—POWER SUPPLY—115 V, 60 cyc. input. Output ranges from 110 V, to 2400 V. Consists of 4 transformers, 2 chokes, 7 oil-filled filter condensers & \$75.00. BRAND NEW. **\$14.95**
Special at only..... **\$14.95**
BC 1267 & RA 105 both for only..... **\$25.00**

AN/APRS—An Airborne superhet radar search rec. Freq. range 1000 to 3000 MC. Rec. has a 10 MC IF band width operating from 80/115 VAC, single phase 60 to 2600 cps, and one amp at 26 VDC. Complete with tubes..... **\$250.00**

COMMAND EQUIPMENT (274N-ARC5, ATA)

	As Is	Excellent
190-550 KC.....	\$7.95	\$10.95
3-6 mc.....	5.95	7.95
6-9 mc.....	2.95	6.95
2-Rec. Radar.....	4.95	6.50
BC 45B Transmitter.....	4.95	6.95
45B Transmitter.....	7.95	9.95
45B Modulator.....	3.95	5.95
Remote Control box and shaft for above, per set.	\$2.50	

ARC-5/R-28 2 MTR RCVR—2 meter superhet, absolutely one of the BEST available today! Times from 100 to 156 mcs. in four crystal channels, easily converted to conventional tuning. Complete with 4..... **\$15.95**
10 tubes. Excellent.....
T-23/ARC-5 Transmitter, 100-156 MC, complete with tubes, Used, Exc..... **\$22.95**
115 or 230 V; 50 to 60 cycle, complete with tubes, photeccel and carrying case. **\$14.95**
As is..... **\$7.95**

DYNAMOTORS

	Input	Output	Price
D-2	11V	375 @ 15 MA.....	\$7.95
DM-32A	28V @ 1.1	250 @ 60 MA.....used	2.95
D-101	27V @ 1.75	285VC-075 amps.....	1.95

Carlson Stromberg Chest Mike—New..... **\$1.29 ea.**

BC 654 TRANSMITTER-RECEIVER

This medium power transmitter and the accompanying 7-tube very sensitive receiver are natural for 80 or 40 meter operation (phone or CW), on either fixed stations or mobile applications. These units are used exc. and come complete with 17 tubes, key, microphone, 200 KC calibrating crystal and instructions and diagrams for use with up to 100 watts input to the final stage on 40 or 80 meters for either phone or CW, using vehicle or 110 Volt power supply..... **\$29.50**
PE103 Excellent..... **22.50**
PE104 Vibrator Supply..... **9.95**
UHF RECEIVER—234-258 MC, used exc..... **\$7.95**
LESS TUBES.....ea.

ASB RECEIVER: Freq. range: 510-555 MC. With tubes New. Reduced.....	\$ 9.95
ASB TRANSMITTER: Freq. Range: 510-555 MC. Complete with tubes. Only.....	4.95
ASB POWER SUPPLY New.....	4.95
ASB ANTENNA SWITCHING UNIT. New Hot Buy!.....	2.95
ASB INDICATOR.....	15.95
ASB CONTROL BOX.....	2.95
All SIX ASB Items—complete.....	34.50

4 for \$10.00

2 Meter Converter—Easily converted to two meters —Used—Excellent, complete with conversion instructions..... **\$3.95**
2 METER OUTBOARD AMPLIFIER—Easily converted to 2 meters—Used—Excellent, complete with conversion instructions..... **\$3.95**
RT/34 APN-13 TRANSCEIVER..... **\$7.50**
Wang radar on 415 MC. Containing a 30 MC IF strip. RF section and various other parts. An excellent buy if only for parts and IF strip. Used..... **\$3.95**
R-1 ARR-1-220 MC converted with minor alterations becomes a high gain converter with two stages of RF amplification (complete with diagram). New..... **\$3.95**
BC 1033, 75 Mc RECEIVER, less tubes, ea. **\$3.95**
BC-655, Rec., 6-9MC—As is..... **\$10.00**
4 for

MOBILE HEAVY DUTY DYNAMOTOR: 14 V. INPUT-output: 1030 VDC 260 MA. Tapped 515 V, 215 MA. use @ 6 V DC INPUT—500 V, 175 MA. While they last—DM-42—Excel. Condition..... **\$8.45**

NAVY ARF RECEIVER

195 KC thru 9 MC. Includes broadcast band. Excellent..... **\$19.95**
Complete with tubes and dynamotor

MN-26-C Remote Controlled Navigational Direction finder and communications receiver. Manual DF in any one of three freq. bands, 150 to 1500 KC. 24 V. Self contained dynamotor supply, complete installation, including receiver, control box, loop, azimuth control. Left-Right Indicator, plugs, loop transmission line and flex. shafts, oper. & main, manual. Ideal for use in boats, etc.

BRAND NEW
MN-20-E Loop, Brand New..... **6.95**
MN-52 Crank drive, New..... **7.50**
MN-261B Receiver exc. freq. 150-1250 KC. 2.9-6mc. **\$39.50**
RM-29. For field phone use includes talk, listen and ringing crkts. Wonderful sub. for EEE less handsets —new..... **\$9.95**

MIKES, HEADSETS & MICROPHONES

T-26 Telephone chest unit with F-1 Western Electric Transmitter..... **\$2.39**
HS-39 Low Impedance Headset..... **\$2.95**
exc. **\$2.95**, new **\$5.45**
HS-23 Headset, used **\$1.89**, new **4.50**
CD-307 Ext. cord for HS-23-33 Like new **\$ 7.95**, new **1.29**
Throat Mike—T-30..... new **.98**
Lip Mike—Navy Type..... new **.98**
CW-49505 High Impedance Headset, Complete with headband..... Used **98c**
T-45 Lip Mike, New..... **\$1.75**
HS-30. Miniature headset. Used **\$1.49**, new **\$2.49**
RS-38 Navy type carbon mike—exc..... **2.95**
Receiver—85 to 1000 MC—Used, Good..... **\$6.50**
Radar Indicator and Shield—Complete with 3BP1, 7-6SN7, 1-2X2, 1-6X3, Brand New..... **\$9.95**
Tuning Units—TU 26 and TU 10. Used, Exc. **\$2.25 ea.**
BC-906 Absorption type Freq. Meter 130-22.5 Mc. Used, Exc..... **\$14.95**

BROADCAST BAND RECEIVER

Navy ADP Receiver DZ-1, made by RCA. Continuous 15 to 1750 kc in 6 bands, gear-train tuning with vernier and coarse scales, broad or sharp band-pass, CW or MCW. All controls on front panel. No headphones or electrical or mechanical interconnections. Beautifully built with 5-gang tuning capacitor, shielded tubes and coils, 8 tubes: 2-6D6, 2-6E6, 2-6C6, 1-1. Complete with tubes..... **\$24.95**
power supply.....

DZ-1 direction finder, complete with all connection, cables & loop, Brand New **\$44.95**

ALL ITEMS F.O.B. CHICAGO

25% Deposit required with orders

R W ELECTRONICS

Dept. N, 2430 S. Michigan Ave., Chicago 16, Ill. PHONE: CAIumet 5-1281-2-3

WRITE FOR NEW BULLETIN AND PRICES.



Its Use in TV (Channels 14 to 83)
Convertors, Tuning Strips, Overall Sets
(Channels 2 to 83)

Its Amateur Applications
Convertors and All Other Equipment

Its Commercial Applications
Microwave Relays—Intercity Relays—
Two-Way Microwave Communication Systems

INTRODUCTION TO UHF CIRCUITS AND COMPONENTS

By Milton S. Kiver

• More clearly than ever before, this book explains all about present-day UHF; its principles; and their application to receivers, convertors and all other equipment. The treatment is exceptionally clear—the operation of every component begins with the most simple statement of how the electrons or waves act, and progresses to a full account of the actual apparatus. Every page shows this author's ability to explain even the most complex topics in plain English, an ability that has brought all his books on television, FM, etc., into the widest use. By the use of vivid descriptions, backed by hundreds of specially chosen and prepared photographs and diagrams, he brings right before your eyes the actual operating principles of every element in the UHF equipment of today, from transmission lines, waveguides and cavity resonators to the various oscillators, antennas and complete receivers. The chapter on measurements alone is worth many times the price of the book to everyone in UHF and television.

Chapter Headings

Introduction to the Higher Frequencies; Transmission Lines at the UHF's; Waveguides; Cavity Resonators; High-Frequency Oscillators; The Magnetron Oscillator; The Klystron Oscillator; The Resnatron. Traveling-Wave Tubes, and others; UHF Antennas; UHF Measurements; UHF Receivers.

Just Published

415 pages, illustrated, \$7.50

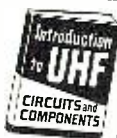

FREE EXAMINATION COUPON

D. Van Nostrand Company, Inc.
250 Fourth Avenue, New York 3

Please send me a copy of "Introduction to UHF Circuits and Components" to examine for 10 days. After 10 days I will either return the book and owe nothing, or send you \$3.50 within ten days, and \$2.00 per month for 2 months until the price of \$7.50 plus a few cents postage, has been paid.

Name

Address

City..... Zone... State.....

(If you enclose check or money order for \$7.50 with this coupon we will pay postage. Return privilege and refund guaranteed.)

RTN-1-55

MANUFACTURERS' LITERATURE

The various listings presented in this section are for your convenience. The bulletins, unless otherwise indicated, are available to all our readers. For prompt attention write directly to the manufacturer for this literature.

1955 ALLIED CATALOGUE

Allied Radio Corporation, 100 N. Western Ave., Chicago 80, Ill., has just released copies of its 1955 general catalogue, listing over 25,000 items and running 308 pages.

The catalogue contains 112 pages of rotogravure, featuring the latest hi-fi components, including 31 complete systems; TV chassis, boosters, rotators, and u.h.f. convertors; table model and portable radio sets; professional and home recording equipment; p.a. amplifiers and complete systems; ham receivers, transmitters and other gear; industrial v.h.f. and radiotelephone equipment, etc. Other listings cover a wide selection of kits and supplies, books, manuals, diagrams, tools and hardware plus thousands of other radio, TV, and industrial electronic items.

Copies of this new catalogue are available from the company without charge.

CBS-HYTRON TUBE GUIDE

CBS-Hytron of Danvers, Mass., has released the seventh edition of its "Reference Guide for Miniature Electron Tubes."

The guide is complete, accurate, and lists all miniature tubes, irrespective of make. Twelve pages of data include 329 miniature tubes of which 79 are new, and 134 basing diagrams of which 27 are new. Larger prototypes are also listed.

The new miniature tube guide is available without charge from the company's distributors.

REPLACEMENT TRANSFORMERS

A new *Stancor* bulletin, No. 469, "TV Replacement Transformer Popularity Tables," has been released by the *Standard Division of Chicago Standard Transformer Corporation*, Addison and Elston, Chicago 18, Ill.

The new publication lists the number of TV models that use each *Stancor* replacement transformer. There are separate tables for each of 100 major set manufacturers. These manufacturers cover over 90% of the sets listed in the guide.

It is designed as an inventory aid for both the TV technician and parts distributor. The user can thus plan a replacement transformer stock based on the sets most popular in his area.

LAMP CHART

United Catalog Publishers, Inc., 106 Lafayette Street, New York 13, N. Y., has compiled a special industry-wide chart on panel and flashlight lamps which it is offering without charge.

The new chart is a composite listing, arranged numerically, of all panel and flashlight lamps manufactured by *General Electric, Eveready, RCA, Raytheon, Sylvania, Tung-Sol*, and *Westinghouse*.

Simply by checking the lamp number the user can determine at a glance the respective manufacturer, bulb type, base, volts, amps, and bead color. To further increase the usefulness of the chart, all bulb types are illustrated with physical dimensions.

TOROIDAL INDUCTORS

Two types of precision-wound toroidal inductors are listed in the new bulletin just issued by *Lenkurt Electric Sales Co.*, 1115 County Road, San Carlos, California.

Bulletin TL2-P4 includes "Q" curves, dimensions, and other data on the company's coil type wound on Carbonyl-Iron cores for high-frequency applications and on its Molybdenum-Permalloy cores for low-frequency applications.

KARLSON ENCLOSURE

Karlson Associates, Inc., 1483 Coney Island Avenue, Brooklyn 30, New York has published a 32-page brochure describing its "Ultra-Fidelity" enclosure.

The booklet starts with the basic problem of what speaker baffle should be used for best results and describes the development of the company's speaker principle. Information is given on the various applications best suited to the cabinet and a discussion of recommended loudspeakers is included.

When writing for a copy of this brochure, please specify Booklet P-49.

SPEAKER CATALOGUE

Oxford Electric Corporation, 3921 S. Michigan Ave., Chicago, Ill. has issued a comprehensive catalogue covering its complete line of speakers for original equipment and replacements uses.

The new multi-colored catalogue illustrates the various speakers and includes complete data on each type.

REPLACEMENT DATA

Chicago Standard Transformer Corporation has issued data sheets on four new exact replacement flyback transformers for *Crosley, Hallicrafters*, and *Du Mont* TV sets.

The units are exact duplicates, electrically and physically, and require no chassis or circuit alterations. The *Stancor* replacement A-8248 for the *Crosley* and *Hallicrafters* models is listed in Bulletin 497 while Bulletin

498 lists flybacks A-8249, A-8250, and A-8251 with their applications in *Du Mont* models.

Write the company at Addison and Elston Avenues in Chicago or contact the local *Stancor* distributor for copies of these publications.

PYRAMID CATALOGUE

The *Pyramid Electric Co.*, 1445 Hudson Blvd., North Bergen, N. J. has issued a new general catalogue, J-8.

The catalogue provides a complete and comprehensive list of all the company's capacitor products normally sold through distributors. The catalogue number, list price, capacity, and physical specifications are included for each component. This 2-color, 24-page booklet is available from the company's representatives or from the company direct.

MERIT REPLACEMENTS

The *Merit Coil & Transformer Co.*, 4427 N. Clark Street, Chicago 40, Ill., is now offering copies of its new replacement guide, #407.

The guide includes about 7000 television models and chassis and lists the replacements for transformers, yokes, flybacks, and i.f. and r.f. transformers.

Copies are available from the company's distributors.

"VERNISTAT" BROCHURE

A new 6-page, 2-color brochure describing the "*Vernistat*" is now available from the *Vernistat* Division, *The Perkin-Elmer Corporation*, Norwalk, Conn.

The brochure fully explains the construction and operation of the component, a new type of precision variable-ratio transformer. The "*Vernistat*" combines the resolution and linearity associated with multi-turn potentiometers with low output impedance characteristics of variable auto-transformers.

HIGH-FIDELITY LINE

An attractive 4-page, 2-color brochure describing and illustrating its new high-fidelity equipment for the home has been issued by *Langevin Manufacturing Corporation*, 37 West 65th Street, New York 23, N. Y.

Pictured and described in the new publication are the company's Model LH-21 equalizer-preamplifier and the Model LH-20 amplifier with mechanical specifications and performance characteristics on each.

A copy of this booklet is available on request.

REPLACEMENT CAPACITORS

A new, seventh edition of its "TV Replacement Capacitor Manual" is now being distributed by *Sprague Products Company*, Marshall Street, North Adams, Massachusetts.

This handy, pocket-sized booklet contains up-to-date capacitor replacement information on 4664 models by 85 set manufacturers. The 65-page manual can be carried in the pocket or tool kit or it may be hung from a

WHILE THEY LAST.....

TG-34A KEYSER: New - \$16.95

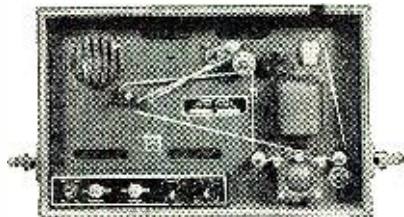

TG-10 KEYSER—Same function as TG-34A, only larger—using 2/6N7-2/6L6-2/6S17-1/5U4G Tubes and 1/923 Photo Cell. Housed in standard Metal Cabinet, can be removed for 19" rack mtg. Size: 11" H x 24" W x 18 1/2" D—USED, \$19.95
TESTED

TG-34A KEYSER—(Pictured) Portable—115 or 230 V. @ 50 to 60 cycles—an automatic unit for reproducing audible code practice signals previously recorded in ink on paper tape. By use of the self contained speaker, the unit will provide code practice signals to one or more people or provide a keying oscillator for use with a hand key. Unit is compact, in portable carrying case, and complete with tubes, photo cell, and operating manual. Size: 10 9/16" x 10 1/2" x 15 13/16". Shipping weight: 45 lbs. NEW—While They \$16.95
Last, only

PRACTICE CODE TAPES:

For use with either TG-34A or TG-10 Keyers—Code training and practice Inked Paper Tapes on 16 MM 400 Ft. Reels, for Telegraph and radio operation:
SEPARATE TAPES for Following Lessons:
Tape #11—Traffic Tape #8—Code Groups
Tape #12—Traffic Tape #2—Receiving
Each on 16 MM Reel, in metal container Ea. \$1.25

BLOWERS:

BLOWER AND HEATING ELEMENT

110 Volt 60 cycle; Blower 100 CFM; Heating Element can be turned on & off separately from blower. Used to pre-heat Transmitter Tubes. Gov't Surplus, #2570 \$10.95



SINGLE TYPE—100 CFM; 2 1/4" intake; 2" outlet, Complete size: 5" x 6"—#1C939..... \$8.95
Dis. Each Side, Complete size: 8" x 6"—#1C880
DUAL TYPE—100 CFM; 4" intake; 2" Dis. Each Side, Complete size: 8" x 6"—#1C880 \$13.95
COMPACT TYPE—108 CFM; Motor built inside squirrel cage; 4 1/2" intake; 3 3/4" x 3" Dis.; Complete size: 4 1/4" W x 8 3/4" H x 8 3/4" D—#2C067 \$14.50
FLANGE TYPE—140 CFM; 3 1/2" intake; 2 1/2" Dis.; Complete size: 7 1/2" W x 7 1/4" H x 6 3/4" D—#1C807 \$13.95
FLANGE TWIN—275 CFM; 4 1/2" intake; 3 1/4" x 3" Dis. Complete size: 11 1/4" W x 8 3/4" H x 9 1/2" D—#2C069..... \$21.95
SINGLE—100 CFM—6 VDC—#6100..... \$7.50
FLANGE—150 CFM—6 VDC—#6150..... 9.95
SINGLE—10 CFM—Min.—24 VDC—#2410..... 5.95
DUAL—20 CFM—Min.—24 VDC—#2420..... 7.95

TRANSFORMERS—115 V. 60 CYCLE PRI.:

600 VCT/100 MA—6.3 V/5 A; 5 V/3 A..... \$4.95
650 VCT/50 MA—6.3 V/2.5 A; 6.3 V/1.6 (Rect. 6x5) 1.95
350 VCT/40 MA—6.3 V/2 A; 6.3 V/1.6 (Rect. 6x5) 1.75
2500 V/0.015 A; 2.5 V/175 A; 6.3 V/6A..... 5.95
1890 V/12.6 MA Tapped 2.5 V. 2 A..... 5.95
1100 V/80 MA; 7.5 VCT/3.25 A..... \$7.95
5 Volt CT-25 A; 10,000 V. Ins. Open Frame..... 7.95
9 Volt CT—35 Amp, Tapped 4.5 Volt..... 5.95
12 Volt—Two separate windings—4 Amp each..... 5.95
28 Volt 8 Amp Tapped 4 Volt..... 2.95
5 V/2 A; 5 V/2 A; 5 V/2 A; 5 V/6 A..... 2.95
600-0-600 VAC—200 MA, 12.5 V. 2 A.; 12.5 V. @ 2 A.; 5 V. @ 3 A.; 115 Volt Primary, H-108, Price..... \$8.95
250-0-250 VAC—50 MA, 24 V. 1 A., & 6.3 V. 1 A.; 115 Volt Primary, H 100—Price..... \$3.95
Current Transformer: Ratio 150 to 5; 25 to 60 cycle, West. Style 81R691..... \$8.95
Choke 12.5 Hy/100 MA..... \$1.95
Choke 12Hy/250 MA, 180 Ohm..... 4.95
Choke 15 Hy/165 MA, 125 Ohm..... 1.95
Choke 5 Hy/150 MA, 85 Ohm..... 1.50

DYNAMOTORS:

HEAVY DUTY MOBILE DYNAMOTOR:

DM-42—14 V. input; output 1030 VDC—260 MA. & 515 V. 215 MA. @ 6 VDC. Approx. half of Voltage..... NEW: \$12.95—USED: \$8.95

INPUT VOLTS:	OUTPUT VOLTS:	MA.	STOCK No.	PRICES:
14 VDC	230	90	DM-21	\$6.95
14	330	150	BD-87	3.95
14	250	50	DM-25	6.95
14	1000	350	BD-77	14.95
12 or 24	500	50	USA/0515	4.95
12 or 24	275	110	USA/0516	4.95
6 or 12	500	160	PE-103	20.95
12	230	90	PE-133	4.95
6 or 12	625/325	150/125	PE-101	4.95
14 VDC	300/160	90/110	BD-83	3.95
14 VDC	350	175	PE-101	4.95

POWER SUPPLY—24 VDC—3 Amp output; 115 Volt 60 cycle input. Completely filtered with 0-75 VDC Output Meter & 2 Tungar Bulbs—Used, Tested..\$12.95

CORDS—CABLES—PLUGS:

CD-605 W/C-410 Trans. & PL-55 F/HS-30..... \$7.79
CD-604 W/C-410 Trans. & PL-54..... .79
CD-874 W/IB-47 Box & PL-55..... .79
CD-265 W/PL-68 Ea. End..... .79
CD-501 BC-654 to PE-103 Dynamotor..... 2.75
CD-280 15 Ft. Single #8 Shielded—15 Ft..... 1.50
CABLE—F/BC-375-191—PL-59-64 or 61 Ea. End Each 2.75
CABLE—TCS—Rec. to P.S. or Trans. to PS. Each 3.00

METERS:

WESTON AC AMMETER:

(Pictured) In portable leather case, with Test Leads, 2 1/2", 0-15 AC and 0-3 AC Scale..... \$5.95



DC AMMETER HOYT: In portable metal case, with Test Leads, 4 1/2", Fan, Mirrored Scale 0-15 ADC..... \$4.95
0-3 RF AMMETER IS-128; 2 1/2" Rd. 0-15 Mtg. Calibrated F/Non Mag. Panel. P/O BC-223 Trans. New: \$2.95
0-500 MICROAMMETER: TRIPLET, 2 1/2" Sq..... 4.95
0-5 MA DC WESTINGHOUSE: 2 1/2" Sq..... 3.95
DB METER: 10 to Plus 6—G. E.—3/2" Rd..... 4.95
TS-291/U VOLTOHMETER..... NEW: 7.95

RECORDER, SIGNAL GENERATOR—AMPLIFIER, & Voltage REGULATOR

RECORDER, SIGNAL GENERATOR—AMPLIFIER AND VOLTAGE REGULATOR UNIT of BC-963 TRAINER—Used for assimilated Radar identification when used with BC-412 Scope. Signal Generator generates various AC wave forms. Recorder was used to record difference in scope and generator wave forms as guided by operator. 110 Volt 60 cycle operation—With Manual. Shipping Weight: 270 lbs. Complete Unit..... NEW: \$59.50

OR AVAILABLE AS SEPARATE ITEMS:

SIGNAL GENERATOR—AMPLIFIER: Can be adjusted for various wave forms, 110 Volt 60 cycle operation. Voltage regulated supply 300 Volt 100 MA, 6.3, 5 A.; 5 Volt 3 A. Power Supply. 15 Tubes, 1/7A6, 3/7A6, 2/7E7, 3/7N7, 1/5Y3GT, and 3/7VR1150 With Tubes and Manual..... \$19.95
RECORDER—Complete with 115 V. 60 cycle 1/125 HP Gear Head Motor, Veeder Counter, Pen, etc. and with Manual..... \$19.95
CONSTANT VOLTAGE REGULATOR—115 V. 60 cycle, 80 VA, Sola #30726..... \$12.95

ANTENNA EQUIPMENT

MAST BASES—INSULATED:



MP-22 BASE—(Illustrated) Ins. spring action; direction of bracket can be raised or lowered easily..... \$2.95

MP-S-33 BASE—Insulated type with heavy coil spring and 5" dia. Ins. Requires 2" hole for mounting. Weight: 9 lbs..... \$5.95

MP-48 BASE—Insulated type base with heavy coil spring. Requires 1 3/4" mounting hole. Weight: 11 lbs..... \$6.95

MP-37 BASE—Insulated type with heavy coil spring. 7" dia. insulator; requires 1 3/4" hole for mounting. Weight: approx. 10 lbs..... \$8.95

AN-75 Telescoping Rod—Only 7 1/2 Ft..... \$0.89
AN-745 Telescoping Rod—Only 8 Ft..... 1.00
AN-130 Gooseneck & Telescoping Rod, 36"..... .89

MAST SECTIONS FOR ABOVE BASES:

Tubular steel, copper coated, painted in 3 ft. sections, screw-in type. MS-53 can be used to make any length with MS-52-51-50-49 for taper. Any section @ 50¢ Each
Larger Diameter Section: MS-54..... 75¢

COAXIAL CABLE & CONNECTORS

CD-1071 CORD—With PL-259 Plugs each end. 50 ohm coax 2 Ft. long. Prices: 50¢ Each—Or in Lots of 10 @ 50¢ Ea.
PL-259—Plug. Ea. End & 32"—RG-54/U—58 ohm. 50¢
SO-239 Chassis Conn. f/PL-259 (Removed), 3 for \$1.00
UG-21/U—Plug ea. end & 32"—RG-11/U—75 ohm. 50¢
UG-22/U—With 4" Coaxial Cable..... 50¢
COAXIAL CABLE: Price Per Ft. 100 500 1000
RG-8/U 51.5 Ohm (Special)..... .07 .06 1/2 .06
RG-34 71 Ohms—145 Ft. Length..... \$15.00 Per Lath.

Address Dept. RN • \$5.00 Minimum, and 25% Deposit on C.O.D. Orders • Prices F.O.B., Lima, Ohio

FAIR RADIO SALES 132 SOUTH MAIN ST. LIMA, OHIO



STEP INTO

**BIGGER
BUSINESS**

with the
NEW

Radion

FIELD STRENGTH METER



Model FSM 5000 Only **\$97.50**
less batteries

BATTERY OPERATED - FOR VHF-UHF

Put yourself ahead of the "cut-and-try" boys. No guessing whether the antenna or receiver is at fault. Save time, money.

On new installations you KNOW which antenna location is best before proceeding. A Radion Meter builds customer confidence, often pays for itself in two months time.

Beautifully designed, easy to use. All TV channels 2 to 83 and FM band. Weighs only 16 lbs. with standard batteries. Absolute readings in microvolts. Monitoring jack for audio. Size 11 x 8½ x 6 in. Ask your distributor or write direct for specifications.



No guesswork
in your methods.

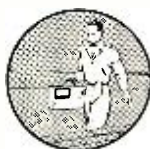

Quickly locate cause
of weak signals.

Radion

THE RADION CORPORATION

Dept. N, 1130 W. Wisconsin Ave.
Chicago 14, Ill.

hook or nail in the service shop by a hole provided in the corner.

Each manufacturer is listed alphabetically, with *Sprague* replacement capacitors fully described and cross-referenced to the original part number. Copies are available free from the company's distributors or for 10 cents a copy from the company direct.

EICO CATALOGUE

Electronic Instrument Co., Inc., 84 Withers Street, Brooklyn, New York is currently offering copies of its new 1955 *Eico* catalogue which lists and describes the firm's 38 kits and 42 factory-wired instruments.

This 14-page publication is exceptionally complete in that each instrument is analyzed as to "features," "specifications," and "applications." The catalogue is available, without charge, upon request direct to the company.

RCP TEST EQUIPMENT

Radio City Products Company, Inc., Easton, Pa. has announced the publication of a new multi-color brochure describing and illustrating its complete line of test equipment.

The publication includes testers for color television as well as black and white, together with many instruments for tube testing and servicing all radio and TV receivers. It also covers instruments for industrial applications in the electronic and related industries.

C-D REPLACEMENTS

A 20-page cross index of recommended C-D replacements of "Tiny-mike" ceramic capacitors for equivalent types of four other principal suppliers has been issued by *Cornell-Dubilier Electric Corporation*, South Plainfield, N. J.

The booklet lists over 830 types of disc, tubular, and high-voltage ceramic units and printed circuit units, with over 400 corresponding C-D substitution catalogue numbers. A special section also cross indexes the company's older and newer numbers.

The "C-D Ceramic Cross Index" is available without cost upon written request to the company. Please specify "Index CPX 654."

PILOT LIGHT DATA

Experimenters and builders of electronic equipment will be interested in the new brochure recently issued by *Dialight Corp.*, 60 Stewart Ave., Brooklyn 37, N. Y.

Entitled "Selection and Application of Pilot Lights," this 8-page booklet presents pilot light lamps with respect to the various options of sizes, bulb shapes, bases and voltages. A chart of 15 most frequently used lamps is presented on the inside cover.

Five of the company's most popular pilot light assemblies are discussed in detail. A copy of Form L-155 will be sent upon written request to Mr. R. E. Greene of the company.

**STAN-BURN
SPARKS**

CATHODE RAY TUBE SPECIALS

One Year Guarantee		G. E.		STAN-BURN	
*10BP4A	\$14.95	*10BP4	\$10.20	*10BP4	\$10.20
*10FP4A	21.10	*12LP4	11.90	*12LP4	11.90
*12LP4A	24.45	*12P4A	13.95	*12P4A	13.95
*12P4A	18.75	*12QP4	11.90	*12QP4	11.90
*12QP4A/B1014	21.00	*12JP4	11.90	*12JP4	11.90
*12UP4B	28.75	*12UP4A	14.50	*12UP4A	14.50
*14CP4	24.50	*14CP4	15.60	*14CP4	15.60
*15RP4/B1014	28.75	*15DP4	17.50	*15DP4	17.50
*Dumont	23.75	*16KP4	17.50	*16KP4	17.50
*Dumont	30.95	*16DP4 or A	17.50	*16DP4 or A	17.50
*16P4A (N.U.)	31.25	*16JP4 or A	17.50	*16JP4 or A	17.50
*16GP4 or B	31.25	*16CP4 or A	17.50	*16CP4 or A	17.50
*16KP4/16RP4	24.20	*16FP4	17.50	*16FP4	17.50
*16KPA (Aluminum)	28.35	*16WP4	17.50	*16WP4	17.50
*16JP4A (N.U.)	25.25	*16PA	17.50	*16PA	17.50
*16P4A	28.50	*16AP4A	23.00	*16AP4A	23.00
*16WP4A	26.50	*16EP4	19.00	*16EP4	19.00
*16GP4	31.25	*16BP4A	21.00	*16BP4A	21.00
*17BP4A	24.25	*17BP4	18.50	*17BP4	18.50
*17P4B	30.30	*17CP4	21.60	*17CP4	21.60
*17CP4	34.00	*17GP4B	22.60	*17GP4B	22.60
*17CP4B	38.50	*19FP4	24.00	*19FP4	24.00
(Aluminum)	41.50	*20CP4	23.90	*20CP4	23.90
*19AP4A	30.00	*19AP4	24.90	*19AP4	24.90
*20CP4	37.50	*19AP4A	24.90	*19AP4A	24.90
*21AP4	31.80	*21EP4	25.50	*21EP4	25.50
*21EP4	36.35	*21AP4	26.50	*21AP4	26.50
*21EP4A	78.50	*24AP4	49.00	*24AP4	49.00

PRICES SUBJECT TO CHANGE WITHOUT NOTICE

AUTHORIZED DISTRIBUTORS for General Electric, Kenrad, Tung-Sol, National Union, De Wald, Regal, Automatic and General Motors.

Automatic Custom-Built Radios for Plymouth, Ford, Chevrolet and many others. Always in stock. We carry a Complete line of HI-FIDELITY and sound equipment. Send us your requests. We also carry a complete line of popular makes of Radio Tubes at 50/10 discount. Also many other special purpose and transmitting types, and all electronic parts and equipment at lowest prices. Send us a list of your requirements for prompt quotations. Terms: 20% with order. Balance C.O.D. All prices F.O.B. NEW YORK Warehouse. Minimum order \$5.00. Write for our latest price list and Hi-Fi catalog to Dept. RN-1.

STAN-BURN RADIO and ELECTRONICS CO.
1697 BROADWAY • NEW YORK 19, N.Y.

Replacement Needling You?

TRY THE

Walco
Packaged

SERVICE PLAN

Service men go for Walco's packaged phonograph needle replacement plan because it's so easy to understand and put to work. No headaches trying to figure out which needle for which cartridge—two easy guides figure for you. And you don't have to be a salesman to sell replacement—even to sell profitable diamond needles—Walco sells 'em for you, by proven methods learned in our long experience as leaders in the replacement needle industry—and as originators of the modern jewel tip needle.

Get all the information—see how much easier it is to sell and service with Walco!

SEND FOR WALCO'S CATALOG 600

Walco TRADE NAME OF ELECTROVOX CO., INC.
Leaders in Replacement Needles
60 Franklin Street, East Orange, N. J.

TV Color Converter
(Continued from page 43)

on the three grids. This is shown in Fig. 2. It is also necessary to add individual background and master background controls, as well as red, blue, and green screen controls, which control the transfer characteristics of the three guns so that a black-and-white picture may be maintained at any brightness setting.

Set-up procedures for the matrixing and background adjustments are adequately described in instruction bulletins available with the 3-gun tube. *Caution:* before attempting to set up the system for a black-and-white picture, it is necessary to pull the two color demodulators from their sockets in order to avoid any confusion until experience is gained with the various adjustments.

The complications from using the 3-gun tube arise from the need for regulated anode, focus, and dynamic convergence voltages. A practical way to build these stages is to use the standard RCA circuitry, specifically that given in the service data for the RCA Model CT-100 color receiver. The circuits used include (refer to CT-100 diagram) V_{127} , the 6SN7GT horizontal oscillator, V_{126} , the 6CD6 horizontal output (with modifications); V_{123} , the 3A3 high-voltage rectifier; V_{121} , the 1X2B focus rectifier; V_{125} , the 6AU4GT damper; V_{120} , the 6BD4 shunt regulator; and V_{119} , the 12AU7 vertical convergence amplifier.

Of course, if you utilize RCA circuits, you must use the standard RCA parts, including a tri-color yoke and the matching horizontal flyback transformer. Also needed are a complete set of dynamic convergence components, a purity coil, and the shielding recommended for the tube.

If you are building your system around the black-and-white Philco chassis described in the December article, you will find that the horizontal oscillator has much too long a flyback time to drive the RCA transformer properly. It is necessary, then, not only to change the horizontal output stage circuitry, but also, the horizontal oscillator circuit should be modified to conform with the RCA circuit. The sync to the horizontal oscillator can still come from the same point in the Philco 1001 chassis, however.

When using the RCA horizontal output transformer, the keying pulse for the burst amplifier may be taken off terminals "C" and "D." Terminal "E" supplies the horizontal dynamic convergence voltage. Terminal "G" is grounded, as in the original RCA circuit. Terminal "F" is left blank, and the rest of the circuitry in the entire dynamic convergence and high-voltage sections should conform with the RCA circuit. The 400 volts necessary to drive this set-up may be obtained quite readily from the black-and-white chassis you are using.

BIGGER AND BETTER THAN EVER!
B-A's NEW 1955

FREE CATALOG

**164
BIG PAGES**

**LOADED WITH
SAVINGS AND
NEW ITEMS
IN RADIO,
TV AND
ELECTRONICS!**

**INCLUDES
23 PAGES OF
AMAZING
BARGAINS,
NOT FOUND
IN ANY OTHER
CATALOG**

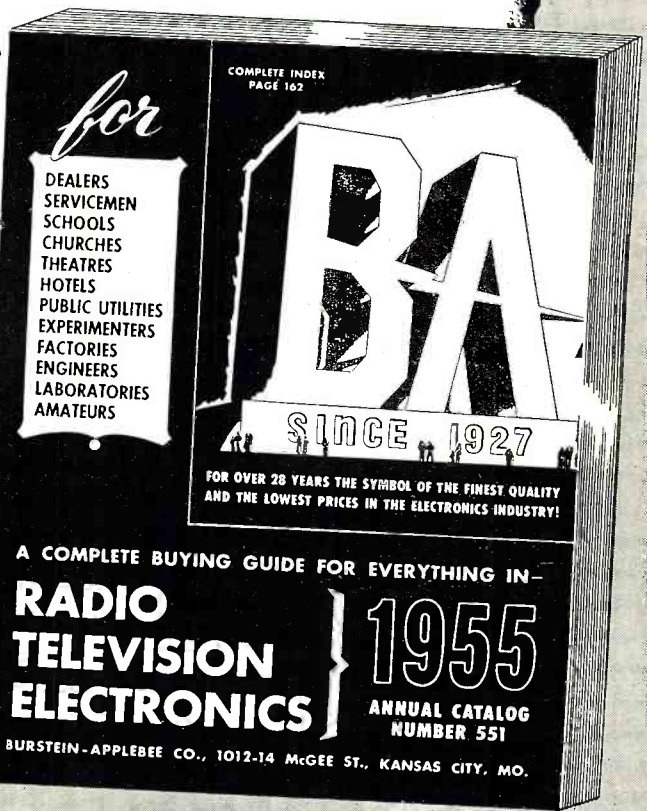

**BURSTEIN-APPLEBEE CO. Dept. M,
1012-14 McGee St., Kansas City 6, Mo.**

Send Free B-A Catalog No. 551.

NAME _____

ADDRESS _____

CITY _____

STATE _____

**FREE
1955 CATALOG
SEND COUPON
FOR IT TODAY!**

ARKAY KITS WORLD'S FINEST

**RADIOS PHONOGRAPHS TV
TEST EQUIPMENT HI-FI**
Write for FREE Brochure

RADIO KITS, INC. • 120 Cedar St., N. Y. 6

FACTORY REPAIRS

ON ALL MAKES AND TYPES OF
TEST EQUIPMENT

Send units via parcel post—
will quote after inspection.

Write for NEW FREE Catalogue

GENERAL ELECTRONIC DIST. CO.

100 PARK PLACE, NEW YORK 7, N. Y.

**RCA MI-2475 SOUND
POWERED PHONES
NEW EXPORT PACKED**

complete with 22' rubber covered cable press to talk switch are light weight, the mic is on a swivel boom that can be moved to any position in front of face. Press to talk switch clips on jacket front can be locked in on position.

NO BATTERIES or other voltage needed—just connect to two conductor wires—good over mile or longer.

Brand new. **\$13.95 Ea.**
Gov't Cost, \$62. Shipping weight 4 lbs.



PLUS THESE EXTRA SPECIALS

TV PICTURE TUBES 14DP4 \$16.00. 16RP4 16KP4, 16TP4 Raytheon Syl. brand new. Guar. . . 18.95
SCOPE TUBE 5BP4. RCA. Dumont. Syl. New. . . 2.95
HEADSET TELEX monostet Mod. 2370 reg. 14.00 3.95
MICROPHONE SHURE 707A & S34B desk stand 3.95
WIRE HOOKUP — 18 solid grey W.E. 1200 ft. roll 2.95
L&S Navy Waterproof speakers brand new each 9.95
RM-29A REMOTE TEL. new W/canvas case. . . 5.95
TEST SET 1-236 for AC DC and Ohms with prods 3.95
MN-26C DF RECEIVER 150 to 1500 KC with 12 tubes dyn. and tuning motor new condition. . . 18.95
BC1023A 75 meg. beacon rec. W/tubes sensitive relay shock mount brand new W/inst. book. . . 8.95
Include postage with order. Min. order \$3.00

McCONNELL'S New Address: BARTO, PA. Phone: BALLY 5-3621

Sherwood

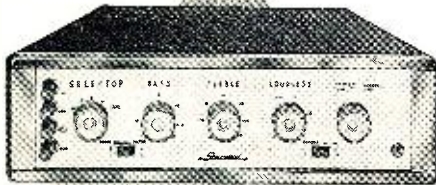

AMPLIFIER

20 Watts Ultra-Linear
6L6 push-pull output, 40 watts peak

Push-Button Phono Equalizer
For LP, RIAA, LOM and EUR curves

Z729 Preamplifier Tube
Phono hum and noise below 1.5 μ V.

Speaker Damping Factor Selector
Range includes -2 and -2

"Center-Set" Loudness Control
New contours extend useful ranges

Tape Recording Jack
Cathode follower, switched for playback

"Pivoting" Tone Controls
Calibrated, accurate flat setting

Rumble Filter Switch

Phono Scratch Filter Switch

Five Inputs and many other professional features

Send for detailed descriptive literature or see your local high fidelity distributor.

Model S1000B \$ 99.50 net
Black and Gold finish

Model S1000C \$104.50 net
Gold-tooled Cordovan Leatherette

Sherwood

ELECTRONIC LABORATORIES

Dept. 1R, 2802 W. Cullom Ave., Chicago 18, Ill.

The grid circuit for the horizontal output tube (6CD6) is modified in order to eliminate the need for a minus 30 volts. (Refer to CT-100 diagram.) The modification consists of simply changing the grid return resistor, $3R_{208}$, from 47,000 ohms to 470,000 ohms, and grounding the cold end. The cathode resistor, $3R_{203}$, should be changed from 12 ohms to 100 ohms, 2 watt, and bypassed with an 8- μ fd., 150-volt capacitor. The screen grid can be supplied from the 250-volt "B+" supply in the converter chassis.

The next requirement will be to obtain the current needed by the purity coil. This can be supplied by paralleling the 20-ohm purity adjustment potentiometer, $2R_{100}$, with the coil, and putting it in series between the output of the choke and the "B+" in the converter chassis.

The vertical convergence voltage can be supplied to the input of the vertical convergence amplifier, V_{110} , without making any changes in the vertical output circuit that you already have in your black-and-white chassis. Again referring to the CT-100 diagram, connect one end of the .47- μ fd. capacitor, $1C_{212}$, to the red wire on the existing vertical transformer. The end of the .1- μ fd. capacitor $1C_{210}$ (in the vertical amplifier shape circuit of the RCA)

goes to the plate or blue lead of the existing vertical output transformer. The end of $1C_{211}$, .22- μ fd. (also in the vertical amplifier shape circuit), goes to the cathode of the vertical output tube.

The remainder of the connections in the vertical convergence circuits should be hooked up exactly as shown in the RCA schematic. The green-and-yellow leads from the existing vertical output transformer should be tied directly to the vertical deflection windings on the deflection yoke. This eliminates any need for vertical centering circuits.

Note: terminal 5 of the flyback is not used.

The "B+" 400 volts from the black-and-white chassis goes to the fuse, $3F_{101}$, which feeds the cathode of the shunt regulator, 6BD4, the plus end of $3C_{221}$, 20- μ fd. capacitor, and one end of the horizontal centering control. This gets the "B+" voltage into the rather involved circuit.

Two more things. Once the tube is set up for proper black-and-white reception, the color mixing circuits operate exactly the same as for the 3-unit projection system described previously. Adjustments needed to converge the tube are covered in the technical data now widely available. -30-

DX-ING WITH THE "TINYMITE"

By L. S. HOOVER

HAVE you ever pulled in OTC (9.76 mc.) in Leopoldville, Belgian Congo with a one-tube receiver measuring 2 1/4" x 1 5/8" x 1 5/8"? The author has! It is six-thousand airline miles between the author's home in Tionesta, Pa. and Leopoldville but OTC was received clearly and there is a verification card at hand to prove this reception.

The "Tinymite," as the author has dubbed his brainchild, has also pulled in London, Guatemala City, Havana, Quito as well as a host of amateur stations all over the U.S. and Canada.

The set is mounted on a Masonite panel which measures 2 1/4" x 1 5/8" and is 1 5/8" deep. It uses a 1Q6 subminiature tube in a superregenerative circuit. The spider-web coils were made by measuring 8 turns of No. 34 B.S. gauge silk-covered wire and wound 8 turns on a spider-web form made of plastic. The plate coil is wound in the opposite direction from the antenna coil. Both coils are placed close together and separated by a spring to control regeneration.

The Hammarlund APC miniature 100 μ fd. capacitor is mounted on the bottom of the panel. Another miniature three-plate capacitor is shunted around this capacitor to control the bandspread. A 100 μ fd. grid capacitor and a 4 meg-ohm grid leak with a 500 μ fd. capacitor connected from plate to ground for regeneration completes the circuit. A 3-30 μ fd. trimmer is connected in series with the antenna lead for close tuning and is very critical.

The set is powered by a 1 1/2-volt filament battery and a 67 1/2-volt "B" battery. Any 1000-ohm headphone may be used.

Anyone with a little mechanical ability can build this receiver. It is simple and straightforward. The tube is mounted

upside down and soldered in with the plate and screen grid leads soldered together. The spider-web coils are mounted just behind the tube. The set is covered by a stainless steel case. Binding posts for the batteries extend from the rear of the case and are insulated from it. The headphone plug-in posts are mounted on the lower right hand side of the panel. -30-

Complete schematic of the "Tinymite" receiver which measures 2 1/2" x 1 5/8" x 1 5/8".

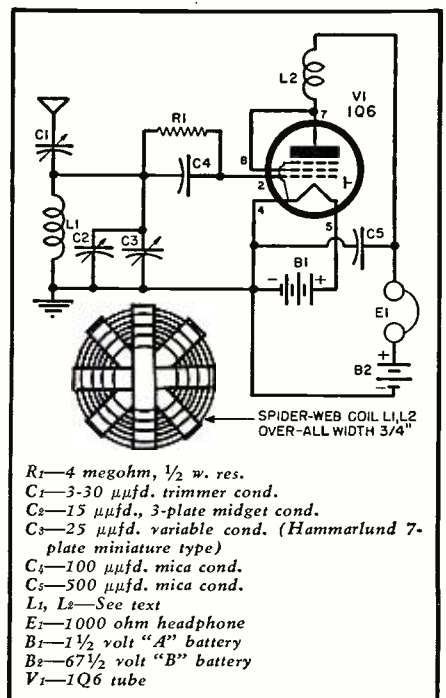

Servicing Color TV

(Continued from page 47)

green light-emitting phosphor dots, the red beam should strike only those phosphor dots emitting red light, etc. Any deviation from this desired action will lead to color contamination which means the appearance of colors other than the desired ones.

When the color purity coil is not positioned properly or the color purity control is not correctly set, then it will be impossible to obtain a pure white (or gray) over the entire screen. If white is achieved in one sector, the raster will be colored elsewhere. Color changes will occur gradually, rather than sharply or abruptly.

To determine whether the color purity is acceptable, the following procedure is recommended.

1. Turn the contrast control to minimum and the brightness control nearly to maximum.

2. Turn the blue and green screen controls completely counterclockwise. Turn the red screen control to the extreme right. This will cut off the currents in the blue and green guns and operate the red gun at maximum.

Now examine the screen, which should contain a red raster. If the red color is uniform over the screen, then purity of this color is indicated. It may be found that some departure from pure red is present near the edges of the screen, but if the color variation is not too great, the condition may be normal for that tube. If in doubt, then it might be advisable to go through the color purity adjustments as prescribed by the manufacturer.

Once a uniform red field is obtained, chances are that uniform green and uniform blue fields will also be obtained. The latter checks are carried out by advancing the associated screen grid control while the other screen grid controls are turned to the left.

Failure to obtain uniform red, green, and blue fields, even after the manufacturer's instructions are carried out, usually signifies that the tube or the purity coil is defective. Defects in picture tubes stem from electron guns that are out of alignment or shadow masks that are warped.

The voltages which are applied to the various electrodes of an electron gun will seldom be the cause of poor color purity. However, they can lead to a raster (or a picture) which is deficient in one of the primary colors. The visual result is as though we had placed a sheet of transparent filter paper over the screen, giving everything appearing on the screen a tinted appearance. The gun responsible for the color deficiency can be isolated by applying the principles of color mixing indicated earlier.

Another reason for a colored raster is improper d.c. and/or dynamic convergence of the electron beams. Color purity, which we have just discussed, serves to force each beam to strike only

SAVE!... BARGAINS GALORE!... SAVE!

Build Your Own Scope! U. S. Gov't Scope Indicator BC-929 Complete with Tubes & 3BPI Cathode Ray Tube

A Real Bargain!! Designed originally as a radar scope indicator, the BC 929A is easily converted to first class lab instrument at a minimum conversion cost. Has extremely high vertical and horizontal sensitivity as well as the extra-wide bandwidth required by microwave radar and television use. Controls include Vert. Centering, Horiz. Centering, Intensity, Focus, Horizontal and vertical amplitude and Sweep duration. Unit originally operated on 400 cycles 110 volt. Tube line-up includes: 2-6H6's, 2-6SN7's, 1-6G6G, 1-6X5GT and 1-2X2. Unit comes complete with tubes and 3BPT cathode ray tube. **\$14.95**



Brand New! In Orig. Box.....

SAVE! CLOSEOUT SAVE! COMMAND SETS

NEVER BEFORE!... NEVER AGAIN!

"Q" 5rs
190-550 KC **\$10.95**

LIKE NEW! XLNT COND.
274N and ARC 5
EQUIPMENT



Type
BC-455 Revr. 6-9 Mc.
Used, with tubes—Like
\$3.95

New
BC-454 Recvr. 3-6MC. Used **\$7.95**
with tubes. Like New.
Dynamotor for above Recvr. \$1.00 ex. with each Recvr.

BC-456 Modulator. Used with tubes.....\$3.95
Sold as is. Less tubes..... 2.95
BC-696 Xmtr. As is. Less tubes..... 9.95
BC-457 Xmtr. 4-2.3 Mc. Used, with tubes... 6.85
Sold as is. Less tubes..... 3.95
BC-458 Xmtr. 5.3-7 Mc. Used, with tubes... 6.95
Sold as is. Less tubes..... 3.95
BC-459 Xmtr. 7-9.1 Mc. Used, with tubes... 9.95
Sold as is. Less tubes..... 5.95
BC-450 3 Revr. Control Box. Used..... 1.49
BC-451 Xmtr. Control Box. Used..... 1.49
3 Receiver Rack. Used..... 1.49
2 Xmt. Rack. Used..... 1.49
12 & 24 Volt Fil. XFMR for above equip. New. 2.49

METERS—WESTON • SANGAMO

All New. All D.C. 2" Square.
0-2 Ma **\$3.29 each**
0-5 Ma **or**
0-15 Ma **3 for \$9.00**
0-50 Ma
0-100 Ma
0-200 Ma
0-300 Ma
0-500 Ma



DC VOLT METERS—2" SQ.
0-20 V. DC **\$3.29 each**
0-40 V. DC **or**
0-300 V. DC **3 for \$9.00**

BC-375 Mod. XFMR. Matches pair of 6146's.
New.....\$2.95

OIL CONDENSERS

2 MFD—GE, 7500 V. New.....\$14.95
2 MFD—5000VDC GE. New..... 6.95
3 MFD—Sprague, 4000 V. New..... 5.95
2 MFD—GE, 4000 V. New..... 3.95
2 MFD—Aerovox, 2500 V. New..... 2.49
4 MFD—CD, 1000 V. New..... .97
10 MFD—Fast, 600 V. New..... 1.49
2 MFD—Aerovox or Solar, 600 V. New..... .3 for .59
4 MFD—GE, 600 V. New..... .97



Brand New!

RADIO COMPASS INDICATOR 1-82A—Part of ARN/ARN-7 Selsyn Controlled

Ideal for use as originally intended, or as a remote indicator for a beam antenna. Unit contains Bendix remote selsyn. Dial scale 0 to 360 degrees with manual compensation adjustment. Numerals and pointer are white on a black background for maximum readability. When used in conjunction with another selsyn mounted on the antenna, Indicator 1-82A will accurately show direction of beam. Units are brand new. Face is 1 1/2" in diameter. Overall depth 3 1/2". Shpg. wt. 2 lbs..... **\$6.95**



T9-APQ/2 200-450 MC TRANSMITTER

10 Watts output—uses 2-385 type tubes as push-pull tunable oscillators. Pair of 807's as modulators. With Tubes... **\$12.95**
Like New.....



BC-306 TUNING UNIT

Used on the General Electric 150W BC-375 transmitter to match it to any type antenna. Excellent for use with any transmitter. Supplied brand new in Orig. carton... **\$2.95**



BC-357

Radio Beacon Receiver
UHF Aircraft Receiver with frequency range from 62 to 80 mc for receiving 75 mc marker beacon signals. Power requirements are 24 volts DC at 1.58 amps and 220 volts at 4.5 milliamps. New **\$4.95**

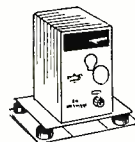

TRANSMITTERS

GP-7 TRANSMITTER

100-watt master oscillator type. Can be used on any frequency from 350 to 9050 KC by using the proper plug-in tuning unit. Type 803 PA and built-in 400 cycle power supply using a pair of 1616 rectifiers. Three 2-inch panel meters: 0-500 MA DC, 0-9 RF, Amps 0-15 AC Volts. A real mine of excellent usable components for building and servicing any high wattage rig. Comes complete with one tuning unit and tubes. Excellent condition..... **\$13.95**

MOBILE GENERATOR NOISE FILTERS—55 amps.
Gov't. Pr. Approx.....\$15.00
With Any Order..... 1.00
W/O Order..... 1.49

TUNING UNITS FOR BC 375 OR 191 TRANS.

TU-7	4500-6200 kc	New \$2.29
TU-8	6200-7700 kc	2.29
TU-9	7700-10000 kc	2.29
TU-10	10000-12500 kc	2.29
TU-26	2000-500 kc	2.29

AM-14/APT

100 MC-160 MC—100 W. Power Amplifier for that 2 meter rig. Pair of 4E27 in final. Complete with 110 W. 400 Cy. power suppl. Less tubes. NT cond.each **\$9.95**

Broadcast Band and Aero MN-26C Installation

A 12 tube remote control manual direction finder desirable for commercial type navigation on boats and planes. Has 3 frequency range of 150 kc to 1500 kc in 3 bands. This frequency covers the beacon and standard broadcast bands. Operates on 28 V. DC input. Complete installation consists of:
MN-26C Receiver, Brand New **\$14.95**
MN-20E Rotable Loop. New **4.95**
MN-52 Azimuth Control Box.....New **2.95**



ARC-4—VHF TRANSCIVER

Ideal substitute for SCR-522. freq. range 140-144 mc. crystal controlled. 10 watts. The receiver section has two individual RF sections, feeding a common 3 stage 10mc IF amplifier. Both RF sections may be operated simultaneously, or either one individually. The receiver unit has 13 tubes. The transmitter is of straight forward design. Transmitter unit has 2 tubes, one 2-3Z2 as final modulated by a pair of 6L6 and push-pull. Complete with tubes. Like New..... **\$19.95**
ARC-4 Dynamotor 12 & 24 Volts..... **9.95**

RG-8/U Co-Axial Cable

180 ft. Roll—two connectors NEW..... **\$10.95**

RG-7/U Co-Axial Cable

100 ft. Roll.....ea. **\$3.95**

500 ft. Roll.....ea. **14.95**

PHONE-CW FILTER

MODEL FL-8
Completely eliminate 1020 cycle CW signals when used on Phone bands—or flip a switch and only 1020 cycle CW signals come thru! Neutral switch position cuts filter out of receiver circuit. Fully self contained in cast aluminum case 3 1/8" x 2 3/4" x 2 3/8" deep. No tubes or internal wiring required. Plug between set phone jack and speaker. New.....ea. **\$1.89**



DYNAMOTORS

PE-101C DYNAMOTOR

6 or 12 Volt

(Reprints of original CQ conversion articles—Oct. and Dec., 1952 issues, furnished.)
• This is the Dynamotor the Hams have been talking about! Easily adapted to supply 625 V. @ 150 MA, and 325 V. 125 MA, at 12 Volts—or 300 V. 90 MA, and 160 V. 110 MA, at 6 Volts. (Illustration shows PE-101C NEW..... **\$5.95**
Eicor Dynamotor—11.6 V. input—425 V.—Output at 375 MA—NEW.....\$10.95
PE-120 Transceivers—6, 12' or 24 V. DC. In.....\$4.95
BRAND NEW.....\$19.95
BD-77 Dynamotors—12 V. input 1000 V. @ 350 MA. NEW.....\$8.95
PE-73 Dynamotors—28 V. 1000 V. at 350 MA. NEW.....\$8.95
USED.....\$3.95
PE-103—New. Orig. Crato—Dynamotor.....\$24.95
Brand New Dynamotor—18 V. input @ 450 input at 60 MA—can be operated on 6 or 12 V.—Orig. cost \$29.50. New—NEW.....\$4.95
PE-126—Dynamotors—14 V. Input—Output 350 V. @ 380 MA.—USED.....\$6.95
Winchester Dynamotor 12 V. Input—Output 60 V. @ 200 MA. Made for TCS Equip. NEW.....\$14.95



Cash with order. Include 4% Sales Tax with California orders—All orders F.O.B. Los Angeles. When in Los Angeles visit our showroom and ask for Paul—W6QDK, Mgr.

SAM'S SURPLUS • 1306 BOND ST. • LOS ANGELES 15, CALIF.

Engineering

WRITERS

ENGINEERS, E. E. or PHYSICS GRADUATES, for preparation of technical manuals...

HUGHES RESEARCH AND DEVELOPMENT LABORATORIES' expanding program for production of radar, electronic digital computers, guided missiles and other military advanced electronic systems and devices requires the following:

1 ELECTRICAL ENGINEERING AND PHYSICS GRADUATES to prepare operating, servicing and overhauling instructions for complex electronic equipment. Those with previous maintenance experience on military equipment preferred. Writers will participate in a three-month program in our technical training school to become familiar with the latest Hughes equipment prior to writing assignments.

2 ENGINEERS EXPERIENCED in the writing and preparation of maintenance manuals for electronic equipment or guided missiles. These specialists will work step-by-step with the people designing, developing and manufacturing the products involved. Experience in the writing of engineering reports is of value.

HOW TO APPLY

Write full details of your qualifications to

HUGHES

Research and Development Laboratories

SCIENTIFIC AND ENGINEERING STAFF

Culver City, Los Angeles County California

Assurance is required that relocation of the applicant will not cause disruption of an urgent military project.

one type of phosphor dot whenever these beams strike the screen. Still required, however, is some means of bringing together all three beams so that each passes through the same hole in the shadow mask at the same time in order that adjacent dots will be activated. This action is needed to insure that the observer will see a single, resultant color from the action of the three beams and not two or three separate colors. In the absence of this converging action, it would be possible for the beams to strike phosphor dots at sufficiently separated points so that an observer would see three individual points of colored light. Under these conditions, mixing the colors would not be possible.

When the d.c. convergence control is properly set, the red, green, and blue pin points of light in each trio of dots will blend together and produce white light on a raster. On the other hand, when the d.c. convergence control is misadjusted, the individual red, green, and blue pin points of light will everywhere be visible. This effect is perhaps best observed with a picture on the screen. The nonregistration of the colors leads to a blurred rainbow effect, such as we occasionally find in rotogravure pictures when the various colors are improperly aligned with each other.

Color impurity and improper d.c. convergence can thus be distinguished as follows: when the color purity is poor, it is not possible to develop uniform red, green, or blue fields on the screen. On the other hand, with poor convergence, individual primary color fields which are pure can be developed, but combination colors cannot.

In addition to d.c. convergence, there is also dynamic convergence. The need for this additional voltage stems from the fact that neither the shadow mask nor the phosphor dot screen are properly curved surfaces. That is, as the beam sweeps back and forth across the face of the tube, it follows an arc such as shown in Fig. 5. The curvature of the screen and the shadow mask deviate sufficiently from this arc so that

Fig. 5. The three electron beams from the three guns of the color tube do not converge at the edges of the curved tube screen because the latter does not conform to the arc made by the focus points.

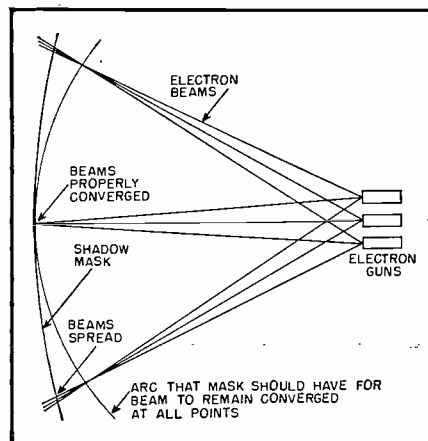

SAVE MORE AT

Harjo

TN-65/APQ-15 for a 2-METER XMITR. Tunes into 27. Little rewiring and adding modulation xfrm. Push-pull 6C4's oscillator driving 832 in parallel. MO tuning from front panel. With 616, 2-6C4's, less 832. With 67 schematics and conversion sheet... **\$7.95**

MICRO SWITCH BZ-TRDT normally open or closed SPDT. New 5 for \$2 postpaid
51.3 OHM COAX. CABLE 100' roll \$4.50
RG-34U 71-OHM COAX. .625 dia. 5 KW rating. 85' roll with p1-173 plug at one end. New 7.95

RCA SURPLUS TV CAMERA

\$225



With 1846 Iconoscope and 6-stage video amplifier and clipper. Complete info. on request.

Miniature Line Matching Transformer

51 plus 25c postage
For blocking oscillators on TV Revers. & camera input circuits, tone oscillator transformer for electric organ, for digital computer systems, 1000's other uses.

24V TRANSFORMER & RECTIFIER COMB. A basic 24 V. DC power supply of 110 V. AC primary, 24 V. secondary and Rectox Rectifier. Operates intermittently up to 3 or 4 amps... **\$2.95**

APS 13 Makes a 420 MC RADIOPHONE

when converted. Range in most cases equal to 2 meters. Complete with RF sections, conversion booklet and 30 MC I.P. strip, less tubes, dynamotor and minor parts not needed for conversion. Shp. wt., 13 lbs. \$3.95



\$14.95 V LUE

WRITE FOR FREE CATALOG! Please send check or MO (no cod's please). All shipments FOB warehouse. Californians, add 3% sales tax.

Harjo Sales Co.

Dept. RM 4109 BURBANK BLVD.
BURBANK, CALIF. Phone: Victoria 9-2411

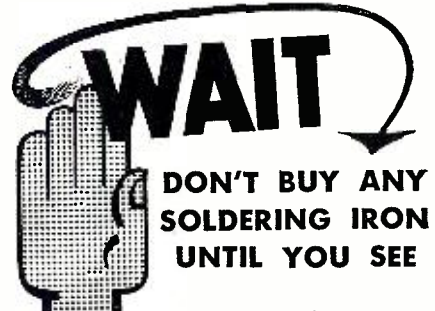

THE **ESICO**
New LUGER
SOLDERING IRON

Makes all other irons obsolete!

The shape of soldering irons to come!

UNVEILING EARLY IN 1955

ESICO

ELECTRIC SOLDERING IRON CO., INC.
DEPT. D DEEP RIVER, CONN.

a beam which is properly converged over the central area of the screen will not be correctly converged at the edges of the screen.

To correct this condition, special parabolic-shaped voltages are added in series with the d.c. convergence voltage and when the system is operating properly, the raster (or picture) is as correctly converged at the edges as it is in the center. It may be that with some tubes a slight amount of nonconvergence is normal at the sides of the screen and here you will see some of the red, green, and blue colors. When the dynamic convergence controls are not properly adjusted or the associated circuits are not functioning properly, then the nonconvergence will be marked.

The distinguishing characteristic of dynamic nonconvergence is the appearance of colors at the edges of an otherwise white (or gray) raster. This effect is best seen on a raster although it may be detected in a picture.

There is one further difficulty that may lead to the appearance of color in what should be a black-and-white picture. This time the effect is that of a picture having a mottled look. The picture contains a background of small colored dots such as you might obtain with colored snow in a picture in place of black-and-white snow in monochrome receivers. The colored dots have no discernible pattern, leading to the conclusion that they are random in nature.

The source of this trouble lies in the chrominance section of the receiver. Ordinarily, with the reception of black-and-white signals, one or more chrominance amplifiers are held beyond cutoff by a negative bias generated in a color killer stage. However, should something prevent this stage from functioning properly, and a killer bias is not developed, then signals will be able to pass through the chrominance section and reach the matrix and beyond this, the three color grids of the picture tube. The random appearance of the color is due to the fact that the 3.58-mc. color subcarrier oscillator is not being synchronized (since no color burst voltages are present in monochrome signals) and consequently there is no definite pattern to the phase of the signal it generates. Color is a product of the combined interaction of signal voltages reaching the color demodulators and the phase of the 3.58-mc. subcarrier.

Colored snow can also be obtained in the absence of any received video signals by the noise picked up by the antenna or generated in the receiver. This behavior is normal and need cause no concern.

Editor's Note: Specific servicing information on the new large screen color TV receivers will appear in this magazine as soon as the sets become commercially available. Elsewhere in this issue will be found Part 1 of the complete service article on the new Motorola color TV set. The recently released RCA 28-tube color TV receiver will be described next.

(To be continued)

Another first from TeleTest!

The first and only combination CRT rejuvenator and tester!



TeleTest
REJUVA-TESTER
combination CRT tester and rejuvenator

SAVE MONEY! SAVE TIME!

An effective rejuvenator alone previously cost not less than \$100!
An effective CRT Tester alone previously cost not less than \$49.95! **REJUVA-TESTER gives you BOTH \$49.95!**

No longer must you drag a chassis back to shop to test and rejuvenate CRT!
REJUVA-TESTER lets you test CRT right in home and for rejuvenate it on the spot!

Model RT-203

There's Never Been An Instrument Like This!

1. *It's a Tester*... Checks CRT for inter-element shorts in both hot and cold conditions. 2. *It's a Rejuvenator*... Removes contamination from surface of the cathode • Corrects gassy (soft) picture tubes • Reactivates cathode • Restores normal CRT performance in 75% of cases.

An instrument that could only come from the famous TeleTest Laboratories that gave you the

TELETEST FLYBACK TESTER!

The Only Flyback Tester that's 100% accurate!

- it tests GOOD flybacks as well as bad!
- now used exclusively in many famous service shops... at John Wanamaker, Sunset Appliances, Winston Appliances!
- the tester that needs no reference flyback!
- tests flyback under full operating voltage!
- tests for even a single shorted turn!
- does not require calibration!

The only Flyback Tester that has won acceptance by TV service men all over the country.

only \$44.95



TELETEST
INSTRUMENT CORP.

31-01 Linden Place
Flushing, New York

"See it today at your jobber!"

1200 Ft. 7" Reel Finest Plastic Base RECORDING TAPE 3 for \$5.55

Buy a "BAKERS DOZEN"

Pay for 12 Reels — Receive 13

We honestly feel that there is no finer recording tape on the market today than the COMPLETE SATISFACTION CHEERFULLY REFUNDED!! sitters under constant Quality

New CONCORDIA Plastic Base High Fidelity Tape. UNCONDITIONALLY GUARANTEED OR YOUR MONEY BACK.

CONCORDIA TAPE is made on precision coaters and Control. Superior dispersion of the red oxide coating results in a tape that is inherently smooth with a strong adherence of oxide to base. Freq. response at 7 1/2 IPS is 40 to 15,000 cycles with extremely low distortion and maximum signal to noise ratio. Oxide wound in. Shpg. Wt. 14 Oz.

7" reels 3 for \$5.55 13 for \$22.20
5" reels 3 for \$3.87 13 for \$15.48

CONCORD RADIO Dept. N1 53 Vesey St., N. Y. 7.
20% deposit with C.O.D. MINIMUM ORDER \$5.00
 Send new CONCORD CATALOG!
NAME _____
ADDRESS _____
CITY _____ ZONE _____ STATE _____
CONCORD RADIO • 53 VESEY ST
NEW YORK 7, N. Y. • Digby 9-1132

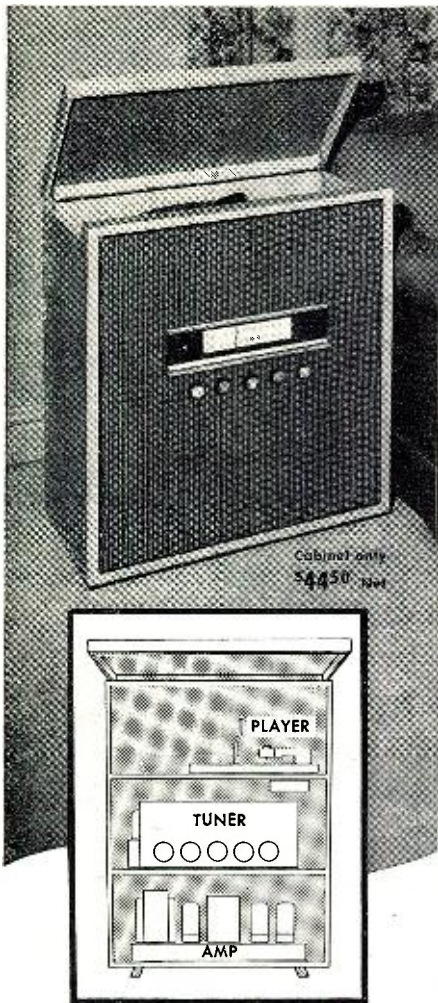

NEW 3-in-1 CONSOLETTA lowers HI-FI cost

At last—the answer to the question, “Where do I put the components?” Its low cost delights everyone. Takes all components—any make or model—as desired.

Also matching cabinets for speakers. Ask wherever high fidelity equipment is sold, or write direct for catalog.



Audio Oscillator (Continued from page 73)

vide adequate isolation, two resonant circuits, each tuned with large values of capacitance, are interposed between it and the detector. These are the plate tank and a tuned filter, coupled by a simple link circuit consisting of a single turn of hookup wire about $\frac{1}{4}$ inch away from the lower end of each coil, connected by a twisted pair of the same wire. The coils are identical except for a tap of 10 turns from the lower end of L_2 . The coils consist of 55 turns of No. 26 enameled wire on $\frac{3}{4}$ inch forms. They are separately shielded.

The oscillator tank inductance L_1 is simply a standard broadcast oscillator coil of the “6SA7” variety for an i.f. of 456 kc.

Preliminary adjustment is made with a v.t.v.m. at the plate of the 6BH6. C_2 is tuned for maximum output, then C_4 , followed by C_8 , which is tuned for minimum deflection. Readjust C_1 and C_5 . Final adjustment is made with the oscilloscope. A pattern of a few cycles of the audio output at a low frequency is obtained, with the sweep tied to the *line*, not the output frequency. Vary C_2 slightly in either direction while observing frequency change. A half turn of C_2 should produce not more than a *very few* cycles change. If this is not the case, tune C_2 in a higher frequency direction, disregarding a possible slight drop in output, until a *very broad* condition is noted. This is the point sought and it is only necessary now to readjust C_1 and C_5 for maximum output as indicated by pattern height. The r.f. across L_2 should not exceed about 4.5 volts r.m.s. after final adjustment.

The crystal is a military surplus item, a CR-2B/U, a plated, wire-mounted type, which is available very cheaply.

Detector and Audio Amplifier

Low level or square-law detection, with a triode, with applied voltages of about .1 volt r.m.s. and approximately equal, is the method used here and is consistent with the policy of limiting high-frequency voltages to small amplitudes. A true square-law heterodyne detector yields distortionless output. In practice this condition can be approximated with adjustment of input voltages and bias. Relative amplitude of the two input voltages, from the standpoint of distortion, is unimportant with this method and output is proportional to their product.

The large component of oscillator frequency in the detector plate circuit, which constitutes a serious problem with high-level, or linear detectors, is not present here. The small amplitudes involved, and the high oscillator frequency, greatly simplify the problem of keeping r.f. out of the audio amplifier. The 100 μfd . capacitor, C_{11} , plus the simple RC filters formed by R_6 and R_{13}

in combination with the input capacitance of V_3 and V_4 are found to limit r.f. in the output to a satisfactorily small amount.

As might be expected there is some attenuation of higher audio frequencies by the detector plate bypass capacitor and filter. Paradoxically, the very characteristics of the components responsible for the attenuation are used to correct this condition and provide a characteristic so flat that variation in output voltage over the entire range can be completely neglected. This is accomplished by providing sufficient gain to permit a large amount of feedback from the 6AQ6 plate to its grid. Since the feedback resistor R_6 connects to the detector plate, the fed back voltage is subject to substantially the same conditions as the original, unamplified voltage, before reaching the grid. Thus feedback is decreased and gain increased with increasing frequency, very nearly balancing the opposing effect.

Although many combinations of tube types, including twin triodes, were tried experimentally as detector and audio voltage amplifier, the combination of 6AV6 and 6AQ6 was found superior to any other arrangement tried. The diode plates of these tubes are grounded. The output circuit shown is simple and satisfactory for most purposes. Output impedance is about 500 ohms and output voltage has been limited to 4 volts r.m.s. This can be very easily increased, but at the expense of an increase in percentage harmonic content.

There are important points in the physical arrangement of the instrument, which, if carefully observed, will reduce drift due to tube heat almost to the vanishing point. The first consideration must be the removal of unnecessary sources of heat, by far the worst of which is the power supply. This source is entirely eliminated by the simple expedient of removing it to a separate chassis. Heat generated by the remaining tubes can be substantially reduced by the use of low heater current types, which is done wherever practical.

With the remaining heat, the irreducible minimum, the objective must be to prevent its reaching frequency-determining elements and to disperse it into the outside air as quickly and completely as possible. To these ends, the instrument is separated into two distinct parts, an upper part or compartment containing all tubes, and a lower compartment containing all frequency-determining elements.

In the upper part free circulation of air is encouraged by adequate openings. The back at this part of the case has been removed, and wire mesh substituted. To retard conduction of heat to the chassis, all tube sockets except those of the oscillator tubes are raised about an inch above it. They are mounted by inserting a No. 8 machine screw about an inch long into the cylindrical shield in the center of the socket where it is secured by

soldering. This makes the socket "one hole mounting." The oscillator tube sockets, whose terminals must be accessible from the underside, are mounted on panels of 1/8 inch Bakelite, covering holes in the chassis considerably larger than otherwise necessary.

The lower compartment, which is as tightly enclosed as possible, has a separate inner cover of heavy gauge aluminum. This affords some protection from changes in ambient temperature and provides a very rigid assembly. This latter is extremely important with the heterodyne oscillator and any extra effort to provide it will be well repaid. This construction and general arrangement, it is believed, afford the greatest freedom from temperature effects consistent with simplicity and low cost.

The power supply is conventional and requires no comment.

In conclusion, the writer would say there is no more interesting circuit than that of the heterodyne audio oscillator. With care, this one can be made an instrument of precision. —30—

What Price Crossover?

(Continued from page 44)

(which probably will not be noticed by the average listener).

The secondaries are each 60 turns of No. 18 Formvar enamel wire, 4 ohms impedance.

The 6V6 tubes were used as these give the best output power for home use although the power output is high enough for other purposes because of the system's efficiency.

Both of the speakers are Oxford heavy-duty units. The tweeter is a 5" model and the woofer a 10" unit. Home power level peaks do not need to exceed 5 watts at any time.

Transformer drive was used as being most suitable for use with the 6V6's. Suitable transformers can be designed for use with other output tubes, providing equal results irrespective of the type of grid input circuit.

The crossover point can be lowered to the 500-cycle point, considered optimum by some audiophiles, by the addition of an air-wound inductance in series with the voice coil of the woofer. This inductance is made up of 200 turns of No. 15 wire on a fiber spool tube, 1" in diameter and 2 1/2" in length. This, however, levels most of the desirable bass boost and although the lower crossover may be desirable, it still lacks clean bass.

This system has an inherent oscillation between 40,000 and 50,000 cycles. A .001 µfd. capacitor is connected from plate-to-plate to cancel all tendency towards self oscillation.

For those whose audio systems require the use of crossover networks, the system described offers the advantages of simplicity and efficient operation. The results fully justify the slight inconvenience of winding the transformer. —30—

January, 1955



For top-notch equipment:

LOOK TO hallicrafters

For top-notch service:

LOOK TO



"The World's Most Personalized Radio Supply House"

THE HALLICRAFTER SX-96

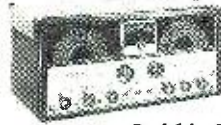

ONLY \$13.62

PER MONTH

\$25.00 DOWN

18 Mos. to Pay

\$249.95 CASH

R-46A Speaker \$19.95

Selectable side band receiver with improved stability through temperature compensation of the HF oscillator circuits and use of the crystal control second conversion oscillators. Precision gear drive dial system on main tuning and bandspread dials. Includes 50 Kc highly selective IF system, AVC-noise limiter and grey-black cabinet with brushed chrome trim. Ship. wt.: 43 lbs.

THE HALLICRAFTER S-85

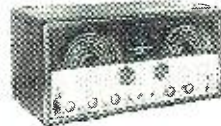

ONLY \$9.54

PER MONTH

\$12.00 DOWN

12 Mos. to Pay

\$119.95 CASH

The receiver with the 10, 11, 15, 20, 40 and 80 meter amateur bands and separate bandspread tuning condenser. Has tuned RF stage, two IF stages for better selectivity, BFO pitch control, AVC-noise limiter and receive/standby. Seven tubes plus rectifier. Broadcast band: 540-1680 Kc. Three short wave bands: 1680 Kc-34 Mc. Chrome-trimmed, grey-black steel cabinet. Shipping wt.: 36 lbs.

OTHER LATE MODEL HALLICRAFTERS

Figure Only 10% Down

Model	Pay Per Month	Cash Price
S-38D	\$ 3.97	\$ 49.95
S-93	7.95	99.95
SX-99	11.92	149.95
SX-62A	19.07	349.95
HT-30	19.07	349.95
SX-88	32.40	595.00

SEND FOR OUR COMPLETE FREE CATALOG!

and information about

- ★ 500 watt, band-switching Globe King
- ★ The new, low-cost "Plumber's Delight" beams
- ★ Our 10% down payment plan
- ★ Over 600 items of Reconditioned Eqpt.



ALL PRICES SUBJECT TO CHANGE WITHOUT NOTICE.

Please send me New Free Catalog and full information on the items checked below! Quote your top Trade-In offer for my: _____

(Name and Make of Equipment)

for your _____ (New Equipment Desired)

- SX-96 S-85 Other _____
- Globe King New WRL Beams
- Down Payment Plan Recon. Equip. List.

NAME _____
ADDRESS _____
CITY & STATE _____

WORLD'S MOST PERSONALIZED RADIO SUPPLY HOUSE

3415 W. BROADWAY, CO. BLUFFS, IA. Phone 2-0277

STOP

CONTAINS THE AMAZING NEW PERMA-FILM!

"NO NOISE"

New 6 oz. Spray Can Net to Servicemen... **\$2.25**

Available in 8 oz. bottles and quart cans. Nearest distributor — or write us today.



VOLUME CONTROL NOISE!

PERFECT CONTACT RESTORER...

Cleans & restores volume controls, band switches, push button assemblies, electrical contacts. NO NOISE is not a carbon tet solution.



- ★ CLEANS! . . . dirt and oxidation immediately on contact.
- ★ LUBRICATES! . . . one drop eliminates scratch, hum and noise.
- ★ PROTECTS! . . . assures continued top performance.

"NO NOISE"

2 oz. bottle. Net to Service... **\$1.00**

ELECTRONIC CHEMICAL CORP.
813 Communipaw Ave. Jersey City 4, N. J.

HARVEY for MOBILE and FIXED GEAR

COMPLETE STOCKS ON HAND
FOR IMMEDIATE DELIVERIES

Here Is a Partial Listing of
POPULAR UNITS
Preferred by Most of Our Customers

B & W 5100.....	\$442.50
Collins 32V3.....	775.00
Collins 75A3 & speaker.....	550.00
Central Electronics 20A kit.....	199.50
Central Electronics 20A factory wired.....	249.50
Central Electronics 10B kit.....	129.50
Central Electronics 10B factory wired.....	179.50
Central Electronics Sideband Slicer kit.....	49.50
Central Electronics Sideband Slicer factory wired.....	74.50
Elmac PMR6A or PMR12A.....	134.50
Elmac AF67.....	177.00
Gonset Super-6.....	52.50
Gonset Super-Ceiver.....	119.50
Gonset Communicator II.....	229.50
Hallicrafter SX88.....	595.00
Hallicrafter SX71.....	249.95
Hallicrafter S76.....	199.95
Hallicrafter S85 or S86.....	119.95
Hammerlund HQ140X.....	264.50
Morrow 5BR.....	74.95
Morrow 5BRF.....	67.95
Morrow FTR.....	128.40
National NC98.....	149.95
National NC88.....	119.95
National NC125.....	199.95
National NC183D.....	383.50
National HRO60.....	533.50
Sonar SRT-120 kit.....	159.50
Sonar SRT-120 factory wired.....	198.50
Viking II kit.....	279.50
Viking II factory wired.....	337.00
Viking Ranger kit.....	179.50
Viking Ranger factory wired.....	258.00

Generous Trade-In Allowances
On Your Present Equipment

Anywhere in the world —

order by mail direct from Harvey. Enclose
estimated shipping charge. Excess will be
refunded.

NOTE: Prices Net, F.O.B., N.Y.C.
Subject to change without notice.

hrc
Harvey
RADIO COMPANY, INC.
103 W. 43rd St., N.Y. 36. N.Y. • JU 2-1500

TV Deflection Circuits (Continued from page 63)

far beyond cut-off. The discharge tube therefore conducts only during the positive pulses to discharge the saw-tooth condenser, C_{17D} . The frequency of the saw-tooth cycles is exactly the same as that of the original sine-wave oscillations.

The first simplification of the sine-wave triggered circuit was the substitution of a triode for the 6K6GT. *G-E* and *Zenith* have used such a simplification in many of their models. For example, the horizontal oscillator and discharge circuit of the *Zenith* Chassis 19L26 is shown in Fig. 5. In order to obtain the required distorted waveform in the output of the sine-wave oscillator, the output is taken, not from the plate circuit, but from a resistor through which the plate current flows. In this circuit, that resistor is

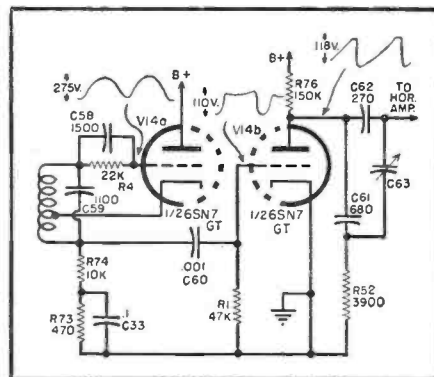
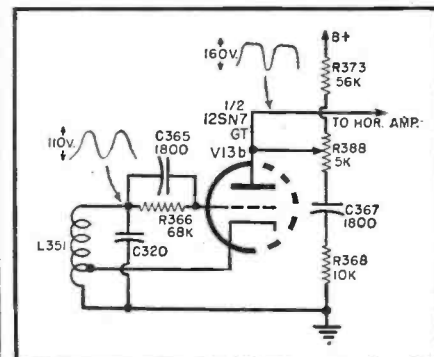

Fig. 5. Zenith horizontal oscillator circuit showing simplification of circuitry over that used in the RCA 630.

R_{74} in the cathode circuit. C_{60} and R_1 comprise a high-pass filter to differentiate the pulse.

A still simpler circuit has been used in several *G-E* models. Fig. 6 shows the schematic of the circuit used in the Model 21T5. V_{13b} is a combination sine-wave oscillator and saw-tooth generator. Generation of both waveforms by the same tube is accomplished by having two circuits in series between the cathode and plate of the tube. The sine wave appears across the tank circuit, L_{351} - C_{320} , and the lower part of the tank

Fig. 6. Horizontal oscillator used in *G-E* model 21T5 and other TV receivers.



YOU'LL SAVE at "WHOLESALE"

RECORDING TAPE

First Quality! Wide Range!



Wide range,
plastic base
recording tape.
1200 ft. on 7"
reel.

249
per
reel.
2.15 per reel
6 or more reels

HI-GAIN VHF ANTENNA

"TEXAS RANGER"

For Ultra Fringe

All channels 2 to 13. High gain for ultra fringe. Rejects co-channel and adjacent channel interference. Gain is better than stacked conical on the low band, equal to or better on the high band.



Model
AX-513

850

TV PICTURE TUBE BOOSTER

Add new life to
picture tubes



95c 90c ea., 6 or more
85c ea., 12 or more

Vu-Brite model C401. For electrostatic magnetic focus tubes.

Write for FREE "FYI" Bulletin No. 301

WHOLESALE
RADIO PARTS CO., Inc.
311 W. Baltimore St.
BALTIMORE 1, MD.

SELL MORE TUBES! SAVE SERVICE TIME!

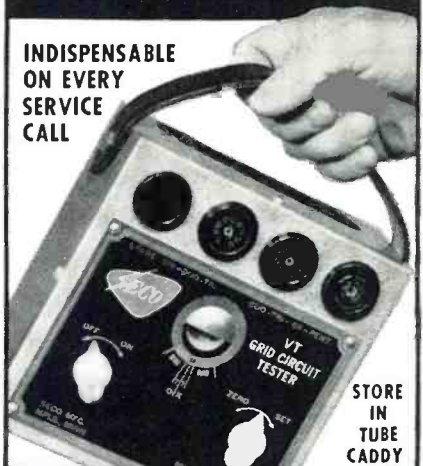

INDISPENSABLE
ON EVERY
SERVICE
CALL

STORE
IN
TUBE
CADDY

PORTABLE

SECO

**GRID
CIRCUIT
TUBE
TESTER**

MAKE THIS 4 WAY CHECK:

1. Control grid emission (Exclusive Feature!)
2. Grid to cathode shorts.
3. Gaseous condition in tube.
4. Cathode to heater shorts.

See your Jobber or write for literature
and prices.

SECO MFG. CO. 5015 PENN. AVE. S.
MINNEAPOLIS, MINN.

RADIO & TELEVISION NEWS

coil is in the cathode-plate circuit. Also in the cathode-plate circuit is the resistance of R_{305} and part of R_{335} and the capacitance of C_{367} . A voltage pulse appears across the resistors and a saw-tooth across the condenser. R_{373} and the remaining part of R_{335} form the charging resistance for the saw-tooth condenser. Moving the tap on R_{335} toward "B+" decreases the charging resistance, thus increasing the amplitude of the saw-tooth, and also increases the peaking resistance, thus increasing the amplitude of the negative pulse in the output of the oscillator. -30-

A B.F.O. AT NO COST

By ARTHUR TRAUFFER

A BEAT-FREQUENCY oscillator (b.f.o.) is necessary for easy copying of c.w. telegraph signals on superheterodynes which do not use regenerative detectors. In short, a b.f.o. is simply a low-power local oscillator which beats with an incoming c.w. signal, thus converting the c.w. "hiss" into a loud "whistle" which is much easier to hear.

A b.f.o. is standard equipment in all communications receivers, but unfortunately it is not included in the combination short-wave and standard broadcast receivers made for the general public. Many code students and potential "hams" use the short-wave bands of their home receivers for learning to copy code, but the lack of a b.f.o. makes copying of weak c.w. difficult through the background noise.

This writer was pleased to discover that he could add a "b.f.o." to his living room "all-wave" radio by simply placing a small a.c.-d.c. superhet nearby. The small table radio's oscillator radiates several harmonics which can be picked up by the short-wave receiver and made to beat with the incoming c.w. signals. Simply tune in a c.w. signal with the short-wave receiver, then turn on the small a.c.-d.c. superhet and adjust its tuning knob until one of its harmonics strikes the c.w. signal. If the effect is too strong, place the small set farther away from the short-wave set. The tone of the beat-note can be varied by a slight adjustment of the small radio's tuning knob. Try this trick, you will be pleased with the results. Now, any short-wave radio can have a b.f.o. -30-

Use a small a.c.-d.c. receiver in conjunction with your s.w. receiver to provide a b.f.o. for c.w. work at no cost for gear.



NEW STOCK OF FIRST QUALITY TELTRON TUBES GUARANTEED! . . . LOWEST PRICES EVER!

All tubes individually boxed . . . unconditionally guaranteed for one year!

GIFT OFFER!
One 6BG6G tube will be shipped FREE with any order accompanying this ad.

FREE BONUS OFFER!



MODEL 625K

- Illum. gear-driven "Speed Rollchart"
- New lever-action switches for individual testing of every element
- Tests all conventional and TV tubes

This Eico Tube Tester is yours FREE when you buy \$199 worth of tubes or more within 60 days at Teltron.

May be bought outright from Teltron for \$34.95

Type	Price	Type	Price	Type	Price	Type	Price
1A7GT...	.53	6AT6....	.37	6J5GT...	.49	12AL5...	.48
1H5GT...	.51	6AU5GT...	.60	6K6GT...	.39	12BA6...	.46
1L4.....	.51	6AU6....	.43	6L6.....	.78	12BA7...	.58
1L6.....	.51	6AV5GT...	.60	6Q7.....	.40	12BE6...	.46
1LC6....	.49	6AV6....	.37	6S4.....	.41	12BH7...	.61
1N5GT...	.51	6AX4GT...	.60	6S8GT...	.65	12BY7...	.65
1T4.....	.51	6AX5GT...	.60	6SA7GT...	.45	12BZ7...	.63
1U5.....	.43	6BA6....	.56	6SK7GT...	.45	12SL7GT...	.60
1X2.....	.65	6BA7....	.58	6SL7GT...	.60	12SN7GT...	.56
2A3.....	.35	6BC5....	.48	6SN7....	.60	19BG6G...	1.48
2A7.....	.35	6BE6....	.46	6SQ7GT...	.38	12SN7GT...	.56
3Q4.....	.53	6BF5....	.48	6T8.....	.71	19BG6G...	1.48
3Q5GT...	.61	6BF6....	.48	6U8.....	.76	19T8....	.71
3S4.....	.48	6BG6G...	1.18	6V3.....	.80	25CU6...	1.09
3V4.....	.48	6BK5....	.75	6V6GT...	.48	25L6GT...	.55
5U4G....	.43	6BJ6....	.51	6W6GT...	.53	25Z5GT...	.55
5V4G....	.49	6BH6....	.51	6X4.....	.37	25Z6GT...	.36
5Y3GT...	.30	6BK7....	.78	6X5GT...	.38	35A5....	.48
5Y4G....	.40	6BL7GT...	.78	6X8.....	.80	35B5....	.48
5Z3.....	.42	6BN6....	.90	7F8.....	.49	35C5....	.48
6A8.....	.40	6BQ6GT...	.83	7N7.....	.49	35L6GT...	.41
6K7.....	.40	6BQ7....	.85	12AL5...	.43	35W4....	.33
6BA4....	.43	6BY5G...	.60	12AT6...	.37	35Y4....	.42
6AF4....	1.02	6BZ7....	.95	12AU6...	.43	35Z5GT...	.33
6AG5....	.52	6C4.....	.41	12AU7...	.58	50A5....	.49
6AH4GT...	.65	6C6B....	.48	12AV6...	.42	50B5....	.48
6AK5....	.96	6CU6....	.95	12AV7...	.73	50C5....	.48
6AL5....	.43	6CX4GT...	.60	12AX4GT...	.60	TYPE 80...	.40
6AQ5....	.48	6F6.....	.42	12AX7...	.61	117L7GT...	1.20
6AR5....	.48	6F5GT...	.44	12AZ7...	.65	117Z3...	.33
		6H6.....	.50	12B4....	.72	117Z6GT...	.65

FREE \$7.20 list value Bonus Box of three 6SN7 tubes and 25 assorted resistors with each order of \$25 or more.

SAME DAY SERVICE

48 Hour Postal Delivery To West Coast

TERMS: Save all freight and postage charges. All orders accompanied by full remittance will be shipped POSTAGE PAID anywhere in the continental U.S.A. 25% deposit required on C.O.D.'s. Minimum order \$10.00. Open accounts to rated firms only.

Send for Free complete tube listing and monthly specials! Get on our mailing list.

SPECIALS!—till FEB. 1st

1B3GT56	6W4GT ..	.37
1R542	12AT755
1U442	12SA742
6AC759	12SK740
6CD6G99	12SQ736
6J649	25BQ6GT ..	.73
6SN7GT ..	.49	50L6GT42

TELTRON ELECTRIC COMPANY

428 Harrison Ave.,

Harrison, N. J.

Dept. RN-1

Phone HUmboldt 4-9848

SCHEMATICS—CONVERSIONS FOR SURPLUS GEAR

NEW LIST! MANY ADDITIONS!

Send stamped, self addressed envelope for List C. Add 25¢ for chart explaining AN nomenclature.

R. E. BOX 1220
GOODHEART BEVERLY HILLS, CAL.

NEW! FREE CATALOGUE!

For bargains in surplus that can't be beat
Get Your Free Copy Today!

MONTHLY SPECIAL: LM FREQUENCY METER: With 1,000 Kc. crystal.
Less book. Good condition. Only \$22.50

J. J. GLASS ELECTRONICS CO.
1615 S. Main St. Los Angeles 15, Calif.

CORONA RADIO KITS

EASY TO BUILD • EDUCATIONAL EXCELLENT RECEPTION

Broadcast Superhet Kit

\$14.75

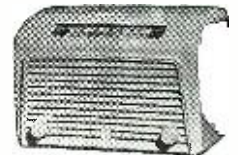

ROCKET 115K—Latest Single Band superhet circuit for ultimate in sensitive reception and total quality. Kit includes all necessary parts, punched chassis, attractive bakelite mahogany cabinet, built-in loop antenna, iron core IF's, big Alnico V spkr.; tubes: 12SK7, 12SA7, 12SQ7, 6U6, 3Z5. Automatic vol. control, beam power output. Tunes 540 to 1700 Kc. Simple step-by-step instructions included.

Plaza 812K 2-Band AC-DC Super Kit...net \$20.75
Globemaster 814K 3-Band Super Kit...net \$24.75
All kits supplied less wire and solder. Please include 25% deposit with C.O.D. orders. Dept. N-1.

CORONA RADIO & TV CO.
370 Broadway New York 13, N.Y.

INVENTORY SALE

Cornell-Dubilier, 70 MFD, 220 VAC (660 VDC) Oil Condenser. Brand New **\$4.75 ea.**
 100,000 Ohm, 100 Watt Wire Wound Adjustable Slider Resistor..... **59c ea.**
 3 for \$1.49

OIL CONDENSER SPECIALS
 Brand New. Ceramic Ins.
 1 MFD 3000 VDC.....\$1.85
 6 MFD 1500 VDC.....2.25
 2 MFD 2000 VDC.....1.50

MINIATURE METER
 0-500 Microamps, 1 3/4" scale, Bakelite case. An accurate tiny meter ideal for CD meters, SWR Bridges, etc. BRAND NEW..... **\$3.75 EA.**
 3 for \$9.50

AMERTRAN PLATE TRANSFORMER
 Pri. 115 V. 60 cy. Sec. 1120-0-1120 Volts @ 650 ma. COS. F. Full cast aluminum case. BRAND NEW..... **\$14.95**

EIMAC VACUUM CONDENSERS
 32,000 VDC
 12 MMF (VC 12-32).....\$8.50
 50 MMF (VC 50-32).....9.50

MOBILE DYNAMOTOR
 6 Volt DC Input. 425 Volts @ 375 ma Output. Made by Elcor and Pioneer..... **\$27.95 ea.**

PANEL METERS
 GOV'T SURPLUS, G.E., WESTINGHOUSE, WESTERN ELECTRIC, SIMPSON, ETC.
2" METERS
 0-4 amp AC.....\$2.95
 0-80 ma DC.....2.95
 0-10 ma DC.....2.95
 0-15 ma DC.....2.95
3" METERS
 0-200 Microamps.....\$6.95
 0-400 Microamps.....5.95
 0-500 Microamps.....5.95
 0-200 Milliamp.....4.50
 0-250 Milliamp.....4.50
 0-3 Milliamp.....3.95
3" METERS
 0-500 Microamps.....\$5.95
 0-50 Mill.4.50
 0-80 Mill.4.50
 0-150 Volts AC.....4.95
 0-750 Volts DC.....5.95
 0-15 Volts DC.....4.95

THE GREATEST METER BUY EVER!
 READ THIS: Westinghouse 3" Meter. Standard Type NX33. Round Bakelite Case. 0-2 Amps DC. Basic 10 ma. can be easily converted to other mill ranges. OUR PRICE ONLY..... **\$2.49**

OIL CONDENSERS

4 MFD-600VDC \$.95	4 MFD-2000VDC \$3.95
4 MFD-600VDC 1.50	6 MFD-2000VDC 4.95
2 MFD-1000VDC 1.25	2 MFD-2500VDC 3.95
3 MFD-1000VDC 1.25	4 MFD-2500VDC 5.95
3 MFD-1500VDC 2.65	4 MFD-3000VDC 8.95
5 MFD-1500VDC 2.95	1 MFD-7500VDC 1.75
6 MFD-1500VDC 2.95	3 MFD-8000VDC 24.95
10 MFD-1500VDC 3.75	.00025 MFD-25KV 5.50
3 MFD-2000VDC 2.95	5 MFD-660VAC 2.95

G. E. RELAY CONTROL
 (Ideal for Model Controls, Etc.)
 Contains a sigma midget 8,000 ohm, relay (trips at less than 2 MA), high impedance choke, bimetal strip, neon pilot and many useful parts. The sensitive relay alone is worth much more than the total low price of... **\$1.25 Each 10 for \$9.90**

PLATE TRANSFORMER
 UTC Linear Standard Grade, Primary 115 V. 60 cycle. Secondary 2400-0-2400 Volts @ 750 ma. BRAND NEW, FULL CASE..... **\$38.50**

MOBILE RELAY
 6 VDC Coil SPST. 30 amp contact for Dynamotor starting plus extra contacts for silencing receiver. SPST normally closed. Made by Struthers Dunn. Specially priced at... **\$89c ea.**

WIRE WOUND RESISTOR KIT. 25 popular assorted—5, 10, 20, 50, 100 watt.....Kit **\$1.95**

READ 'N' SAVE BARGAINS
 6 Henry 80 ma chokes......85
 Heinenmann ckt brkr. 5.5 amp. 110 V......95
 Var. ceramic trimmer 7 to 45 mmf......25
 Erie 500 mmf ceramicons......10 for .50
 15V AC relay SPST 15 Amp contacts.....1.75
 220V AC relay SPST 15 Amp contacts.....1.75
 .01 mmf. 1000 VDC Micacs......5 for .95
 .0004 2500 VDC Micacs......5 for .95
 .04 600 V Micacs......5 for .95
 100,000 ohm. 100 Watt resistor......45
 250 ohm 100 W. non ind. resistor......59

Min. Order \$3.00—25% with Order—F.O.B. New York.
PEAK ELECTRONICS CO.
 66 West Broadway, New York 7, N. Y.
 Phone WOrth 2-5439

International Short-Wave (Continued from page 80)

Guatemala—TGNA, 9.668, noted with *English* 2200-2345 closedown. (Herrmann, N. H., others) And parallel over TGNC, 11.850. (Young, N. Y.) TGWB seems to have settled down on 6.196A, noted around 2030. TGNA, 5.9525, noted on a Friday at 1900 with Spanish-*English* lesson. (Niblack, Ind.) TGWA, listed 9.760, now seems high as 9.765. (Cox, Dela., others)

Haiti—Radio Commerce sent a photo-QSL card which shows views of modern studios. (Joel Levy, N. Y.) Good level over 4VC, 9.485, around 0800. (Hicks, Ga.) 4VEH, 9.656A, strong in *English* around 0830-0930. (Thurber, N. Y.)

Honduras—HROW, 6.025A, Tegucigalpa, noted 1858 with musical program in Spanish; bad QRM. (Cox, Dela.) HRTL, 6.035, *Radio Tela*, observed at fine level 2245 with Latin-American music. (Niblack, Ind.)

Hong Kong—ZBW3, Victoria, noted 0600 with BBC news relay. (Cox, Dela.; Sutton, Ohio)

Hungary—Radio Budapest, 11.910A, parallel 9.833, noted in *English* when tuned 1520. (Cox, Dela.) Revised schedule includes *English* for North America 1930-2000, 2300-2330 on 6.248, 7.220, 9.833. (Radio Sweden, others)

India—WRH lists latest schedule for the *External Services of All India Radio* as General Service (for Indians Overseas) to East and Southeast Asia 1930-2000, 9.755, 11.950 (*English* 1930-1940); 2030-2145, 11.870, 15.160 (recorded Indian music); 0500-0645, 17.840, 21.700 (0500 Hindi, 0545 Tamil) To East and Central Africa, Mauritius 2300-0010, 11.790, 15.130 (*English* 2310-2320, Hindi 2320); 1000-1030, 15.150, 17.840 (Hindi), 1045-1055 (*English*), and 1130-1215, 11.620, 15.150 (Gujarati). To West Indies 1830-1930, 6.190, 7.165, 9.755, 11.950 (composite program in Hindi and *English*). In the Eastern Service to South and Southeast Asia in *English* 0830-0945, now uses 11.620, 15.150. Has *English* for Europe in Western Service 0230-0330, 15.255, 17.740.

Indo-China—Radio France - Asie, 9.755A, Saigon, noted at fair level in language and music 0425 tune-in. (Cox, Dela.) This outlet appears now to carry *English* around 0900-1100; has French-*English* lesson, at least some days, at 1045; 6.115 still has news in French 1015, signs off 1030. (Balbi, Calif.) Announces news for 0830. (Morgan, Calif.) Former *Voice of Vietnam*, Saigon, 9.625, now announces as *The Voice of Free Vietnam*, noted in Japan with news, commentaries, music from 0830. (JSWC) *Radio Hue*, 7.205, noted in Japan 0825-0852 sign-off with musical program in French. (JSWC)

Iraq—Radio Baghdad, 11.705A, tuned 1359; at 1400 clock chimes struck 10 p.m., gave all "Ici Radio Baghdad," and "Huna Baghdad," then had news in Arabic 1402-1415; *English*

1415-1500 sign-off; news 1430-1440. (Sutton, Ohio) Noted 0030 with Arabic news and music. (Sanderson, Australia) *English* 1415-1500 closedown noted over the 3.295A outlet. (Pearce, England)

Israel—Tel Aviv, 9.008, noted in *English* 1615-1700 or later; still asks for reception reports to Box 754, Jerusalem, Israel. (Chamberlayne, Va.; Arthurs, Pa.; Hicks, Ga.; Guilbert, Germany, others)

Italy—RAI, 6.260, Palermo, noted in Italian 1540, weak to fair. Milan, 6.240, fair level with music and announcements in Italian around 1700, parallel 9.420. (Cox, Dela.) Rome, 15.400, noted in Arabic closing 1430. (Niblack, Ind.) Heard on 9.63 and 6.010 at 0420-0440 with *English* for Africa. (Guilbert, Germany) Heard opening to North America on 9.575A, fair to good level in Ill.; according to announcement, 6.010 should parallel now. (Foster) *English* for Australia, Pacific 0400-0435 noted on 7.180 in addition to announced 11.90, 15.32. (Pearce, England)

Ivory Coast—Radio Abidjan, 4.945, noted when tuned 1545 to 1628 when closed with "La Marseillaise," excellent signal, no QRM; also heard opening 0215 with 6-note musical interval signal, then "La Marseillaise," then had musical program, all in French, fair to good level in N. J. (Cox)

Jamaica—Radio Jamaica, 3.360, noted to 2351 sign-off. (Machajewski, N. Y.)

Japan—Radio Japan, 9.695, noted around 0400. (Mast, N. Y.)

JK021, 6.005, opens daily 1500 and relays First Network of NHK; JKG21, 6.175, noted 2100 with relay of NHK-II; JKM21, 6.190, heard closing 0300. (JSWC)

Kenya Colony—Nairobi, 3.315, 2.5 kw., operates 1330-1500 with same program as on 4.885. (Collett, N. Z.) JSWC says *Forces Broadcasting Service*, 7.265, Nairobi, has been heard 1039-1130, with world news 1045.

Kuwait—Al Kuwait, 5.000, is heard in Japan with Arabic 1300-1600. (JSWC)

Leeward Islands—Radio Montserrat broadcasts in *English* on 3.255, 0.075 kw., Sunday 1500-1530, Wednesday 1315-1330, 1400-1430. (WRH)

Libya—British *Forces Broadcasting Station*, Benghazi, is audible on 7.220 to 1115 closedown; reopens 1130 on 3.305 and closes there 1600; both outlets are still *experimental*. (*La Radio Mondiale*, France) Latter channel heard well in Britain; relays BBC news 1300. (Pearce)

Luxembourg—Radio Luxembourg, 6.090, noted at good strength 0325 with popular music, announcements in French. (Cox, Dela.)

Madagascar—Radio Tananarive, 9.515, noted from 2230 sign-on (in French) to 2350 fade-out; the 9.693 outlet noted at weak level 2240 with native (Malgache) session. (Cox, Dela.) The 7.375 outlet is heard in Japan 0700-0900; carries Malgache but also identifies in French. (JSWC)

Malaya—BFEB, 11.820, Singapore, is heard on Okinawa at good strength 0800 with BBC news relay from London. (Bates) Heard on 9.690 at 0520 tune-in with music, news 0530. (Sutton, Ohio) Is using new channel of 15.310 in *English* 0915-1135 (Sunday to 1150, Saturday to 1220); is again using 15.300 in Burmese 0915-0930. (JSWC) *Radio Malaya*, 4.820, Singapore, noted in Tokyo 0900. (JSWC)

Mexico—XESC, 15.205, Mexico City, all-Spanish program, very good around 1900 with popular music and singing commercials; sends nice verification card picturing Mexican landmarks; reports requested. XEBR, 11.820, Hermosillo, Sonora, also QSL's promptly. (Kahan, Calif.)

Mozambique—CR7BU, 4.930A, Lourenco Marques, noted at good level 1645 with popular music to sign-off 1700. (Cox, Dela.) The regional station of *Radio Clube de Mocambique* at Nampula operates on 1213 kc., 0.3 kw., 0500-0600, 1130-1330; on 6.152, 1 kw., 0500-0600; on 3.535 in winter, on 4.930 in summer, at 1130-1330. (WRH) *Emissora de Aero Clube de Beira*, Caixa Postal 3, Beira, is on the air over CR7IC, 3.567, 0.45 kw., and CR7IB, 7.255, 0.35 kw., 0430-0630, 1100-1500; news in Portuguese 0500, 1235. (WRH)

New Caledonia—*Radio Noumea*, 3.375, noted 0445 with French news, music. (Sanderson, Australia)

New Zealand—ZL3, 11.780, Wellington,

noted with music to 2300, good level in Idaho. (McDaniel) ZL7, 6.080, heard at good strength 0230. (Cox, Dela.) Is good signal in British Columbia from around 0100 to 0545A close-down. (Adam)

Nicaragua—YNWW, 5.942A, is fair with Spanish music around 1850; considerable CWQR.M. (Cox, Dela.)

Nigeria—*Radio Nigeria*, 4.800, Lagos, noted 1600; news 1630-1640, closes 1700A with "God Save the Queen." (Cox, Dela.) North Regional transmitter on 3.326 is good level at 1335 with African music. (Pearce, England)

North Borneo—*Radio Sabah*, Jesselton, is scheduled on 7.237, 250 watts, 2250-2400 Sunday, Tuesday, Thursday, *English*; 2300-2345 Monday, Wednesday (2300-2320 Mandarin, 2320-2330 Hakka, 2330-2345 Malay); 2300-0015 Saturday (2300-2345 same as Monday, Wednesday; 2345-0015 alternating with Malay and Mandarin). A new 5-7.5 kw. transmitter will be installed in March or April with tests scheduled to begin around June or July; frequencies allocated besides present one include 5.980, 6.090, 7.180, 7.240, 9.660, 9.740.

Northern Rhodesia—ZQP, Lusaka, is scheduled weekdays 3.346, 1100-1400; 4.826, 0500-1400, and 7.220, 0500-1050; Sunday, 3.364, 1100-1405; 4.826, 0330-1405, and 7.220, 0330-1050. (Hardwick, N. Z.)

North Korea—Pyongyang noted parallel over 2.850, 6.250, 4.400 at 0730-0800. (JSWC)

Norway—LLM, 15.175, Oslo, noted Sunday 1200-1220A with "Norway This Week" (*English*), good level in N. Y. (Joel Levy) *Winter* frequencies to North America are 6.130, 7.210, 9.610, 1578 kc., beamed to East coast 2000-2100 and to West coast 2300-2400; on Sunday at end of each of these transmissions has "Norway This Week" (*English*) for approximately 20 minutes. (Halvorsen, Norway)

Pakistan—Karachi noted in Home Service with news 0945-1000 on 6.235, 9.484. (Morgan, Calif.) Is audible some days on 11.723 at 2100 with news. (Balbi, Morgan, Calif.) Heard on 17.750 with news in progress 0805. (Ferguson, N. C.)

Panama—HP5J, 9.607, Panama City, fair with popular music, Spanish announcements 2005; slight QRM from *Radio Norway*. H050, 5.995, Panama City, noted at fair level, slight heterodyne, 1750 with Spanish music and language; HORT, 6.060A, Panama City, noted 1930 when identified as *Radio Balboa*, then had music. (Cox, Dela.)

Paraguay—*Radio Telco*, ZPA3, 11.852A, Asuncion, noted at good level 1810-1830 with all-Spanish program; this one is logged rarely. (Niblack, Ind.)

Philippines—DZH7, 9.730, Manila, has been logged 0710 with religious program in progress; *English*. (Cox, Dela.) According to schedule received, has news 0200, 0400, 0800, 1800, 2200,

Just Out

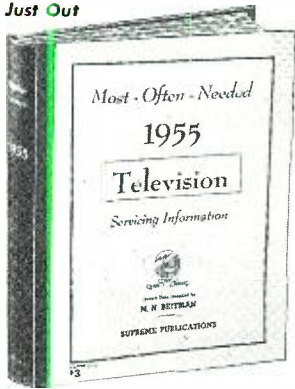

Covers all important 1955 Sets

New SUPREME 1955 TV Manual

AMAZING BARGAIN

The new 1955 TV manual is the scoop of the year. Covers all important sets of every make in one giant volume. Your price for this mammoth manual is only \$3. This super-value defies all competition. Other volumes at only \$3 and \$2 each. Each manual has a whole year of service material. Includes all data needed for quicker TV servicing. Practically tells you how to find each fault and make the repair. More pages, more diagrams, more service data per dollar of cost. Get the best for less. Get SUPREME.

COVERS ALL POPULAR SETS

Supreme TV manuals have all needed service material on every popular TV set of every important manufacturer. Here is helpful, practical, factory-prepared data that will really make TV servicing and adjustment easy for you. Benefit and save with these amazing values in service manuals. These giant TV manuals have complete circuits, alignment facts, test patterns, response curves, service hints, all recommended changes, voltage charts, waveforms, and many double-page diagram blueprints. Here is your TV service material to help you do more expert work quicker; and priced at only \$3 and \$2 per manual covering a full year of material. Be ready to repair any model by having in your shop all nine TV volumes listed in coupon below. Or try the new 1955 TV manual to see what an amazing bargain you get for only \$3. Send trial coupon.

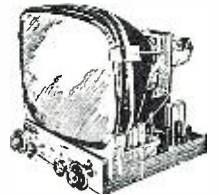

The repair of any television set is really simple with *Supreme* TV service manuals. Every set is covered in a practical manner that will simplify troubleshooting and repair. This is the help you need to find toughest faults in a jiffy. Each \$3 TV volume covers a whole year of service material. New *Television Servicing Course* will aid you in learning TV. Be wise, buy *Supreme* Manuals only once each year instead of spending dollars every week for not needed data.



TELEVISION SERVICING COURSE
Let this new course help you in TV servicing. Amazing bargain, complete, only \$3, full price for all lessons. Giant in size, mammoth in scope, topics just like a \$200.00 correspondence course. Lessons on picture faults, circuits, adjustments, short-cuts, UHF, alignment facts, hints, antenna problems, trouble-shooting, test equipment, picture analysis. Special, only **\$3**

Newest



RADIO DIAGRAMS

Here is your best complete source of all needed RADIO diagrams and service data. Covers everything from most recent radios to pre-war old-timers; home radios, auto sets, combinations, changers, and portables. Sensational values. Still sold at pre-Korean prices. Only \$2 for most volumes. Every Radio manual contains large schematics, all required alignment facts, parts lists, voltage values, trimmers, dial stringing, and helpful service hints. All volumes are large in size, 8 1/2 x 11 inches, about 192 pages. See coupon at right for a complete list of these low-priced manuals.

NO-RISK TRIAL ORDER COUPON

SUPREME PUBLICATIONS, 1760 Balsam, Highland Park, ILL.

Radio Diagram Manuals

Most-Often-Needed Series (See full description at left)

- 1954 Radio Manual, \$2.50
- 1953 Diagrams
- 1952 Radio
- 1951 Diagrams
- 1950 Manual
- 1949 Radio
- 1948
- 1947
- 1946
- 1942
- 1941
- 1940
- 1939
- 1926-1938 Manual, \$2.50
- Master INDEX, only 25¢

- New 1955 Television Manual, \$3.
- 1953 TV Manual, \$3.
- 1952 Television Manual, \$3.
- 1950 Television Manual, \$3.
- 1948 TV, \$3.
- Television Servicing Course, complete, only...\$3.
- 1954 TV, \$3.
- UHF Manual, \$1.50
- 1951 TV, \$3.
- 1949 TV, \$3.
- 1947 TV & FM, only \$2.

PRICED AT ONLY **\$2** EACH

I am enclosing \$..... Send postpaid.
 Send C.O.D. I am enclosing \$..... deposit.

Name:
Address:

Supreme Publications
Sold by All Leading Parts Jobbers

PHOTO FLASH

100 W. SEC. STROBE OUTFIT

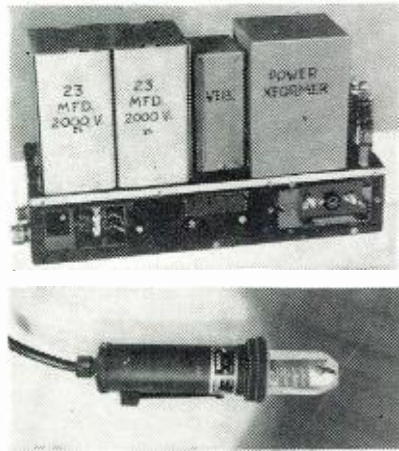

LAMP ASS'Y & FLASH BULB

Ideal for outdoor photography by attaching to auto battery on 6, 12 or 12.24 VDC source or used indoor for studio—Complete w/Lamp ass'y, ignition coil & trigger housing & 20 Ft. cord—Uses 5v. 1A-1073 200 W.S. Bulb (similar to Syvet 4330 but has Pyrex covering) BRAND-NEW ready to operate w/instruction manual—Sh. Wt. 50 lbs.—.....\$29.95

INDIVIDUAL PARTS AVAILABLE—WRITE TODAY!

"IDEAL" MODEL 5 C SOLDERING PLIERS & TRANSFORMER—Thermoplastic carbon pliers & connecting cables—115 VAC 60 cy. 10 amp. input—OUTPUT: 3.5/4.5 V @ 90 amp. Int. or 60 amp. cont. duty —In metal carrying case which can be used for tool box—BRAND-NEW—Wt. approx. 25 lbs.—\$24.95 New\$4.95
 3 to 5 H/500 ma Choke—100 ohms—2500 V. Ins.—New\$4.95
 15 H 200 ma (ICAS)—125 ohm Choke—New.....\$2.95
 RHEOSTAT—4500 ohms 150 Watt—Ohmite Model L—Open case—4" dia. x 2"—W.W. Linear taper—New\$3.95
 RHEOSTAT—8 ohms 50 Watt—IRC PR-50—Metal case 2 3/4 x 1 3/4"—W. Linear taper—New.....\$1.50
 BC-221 TECHNICAL MANUAL—NEW—Prepaid.....\$1.25

SPECIAL

NEW SHIPMENT JUST ARRIVED

TG-34-A CODE KEYS—115/230 VAC 50-60 cycle. Has self-contained oscillator for hand keying or use with paper tape. Complete with tubes, photocell & manual in metal carrying case 10 9/16 x 10 1/2 x 1 1/2". Sh. Wt. 45 lbs.

BRAND-NEW \$16.95 LIMITED QUANTITY

TG-10 CODE KEYS—similar to above but more audio output—mtz. in 11 x 24 x 1 1/2" metal cabinet. Used, excellent.....\$14.95

INDIVIDUAL TAPES for the following lessons—#1, #2, #8, #11—New in metal containers—ea.....\$1.25
 WESTINGHOUSE PX-14 D.C. AMMETER—10% accuracy. 1-10 amps. Open face portable. P.M. moving coil. .005 ohms—3 1/2" meter face—4 1/2 x 3 1/2"—with test leads & leather carrying case. BRAND-NEW in orig. box\$9.95
 0-200 DC UA METER—500 ohm per 1 V—D'Arsonval movement—2 1/2" round body—4 1/2 x 3 1/2" feet. flange. New—Boxed\$6.95
 0-200 DC UA—Triplet 2 inch.....New \$5.50
 0-150 VAC—stark 47 M—3" square.....New 4.95

25% WITH ORDER. BAL. INCL. POSTAGE C.O.D. MICHIGAN RESIDENTS ADD 3% SALES TAX. PRICES SUBJECT TO CHANGE WITHOUT NOTICE. ALL MERCHANDISE SUBJECT TO PRIOR SALE.

AARON ELECTRONIC SALES

3830 Chene Street Detroit 7, Michigan

VIBRAPACS

6 VOLT NAVY VIBRAPAC 250V 165MA. Fused. Filtered & with control relay.....NEW \$15.95
 KIT of basic components to build above unit, less chassis, with diagram.....NEW \$6.95
 6 VOLT Willard storage battery, 20 Amp. hrs. NEW \$2.95

DRILLICK ELECTRONIC SALES CO.

5279 W. Pico Blvd. Los Angeles 19, Calif.

"SNOOPER" GEIGER COUNTER



Super-sensitive! Only 1 1/2 lbs! Fits pocket—uses flashlight battery. Find a fortune in uranium. Order Now! Send \$5.00, balance C.O.D. MONEY BACK GUARANTEE. FREE CATALOG—scintillator and larger uranium and metal detectors. DEALERS WANTED.

29.95 COMPLETE

PRECISION RADIATION INSTRUMENTS
 2235 RT S. La Brea, Los Angeles 16, Calif.

2400 Monday, Thursday, Saturday on DZH7, 9.730. DZH8, 11.855. DZH9, 15.300, and DZ16, 17.805. (Bulmur, Manitoba) Recently announced in (*English*) Mailbag session ending 1000 that does not confirm listeners' reports unless preferably a full half-hour of program material is given in report. (Morgan, Calif.) DYH2, 6.140, heard 0500 with news. (Sanderson, Australia) DZH4, 6.000, Manila, noted with popular music 0515, good level in N. Z. (Hardwick)

Poland—Radio Warsaw. 6.025, noted ending *English* session 0100. (Morgan, Calif.)

Portugal—Lisbon, 6.374, good level with music in Portuguese 1755. CSB52, 6.154, Lisbon, noted at good level 1745 with identified in Portuguese, then had music. (Cox, Dela.) CSB51, Radio Clube Portugues, Parede, is well received in France on its new channel of 6.080, heard around 1600. (*La Radio Mondiale*, France)

Roumania—Radio Bucharest, 9.570, excellent in *English* when tuned 1440. (Cox, Dela.) And 1730-1800. (Pearce, England) Noted over 9.252A at 1720 at fair level in language. (Cox, Dela.)

Sao Tome—Radio Clube de Sao Tome, 4.807, is heard in Japan around 1530-1605 in Portuguese, when closes with "A Portuguesa." (JSWC)

Saudi-Arabia—Djeddah, 7.100A, is heard in Japan around 1115-1200; at 1122 has interval signal by native flute and march. (JSWC)

South Africa—Johannesburg, 4.897A, fair to good level 0000 with news in Afrikaans. (Cox, Dela.) The *English* commercial service from Johannesburg, 4.945, noted with interval just prior to 2300 sign-on; rather poor level; followed with program of popular recordings and commercials by announcer; often has bad QRM. (Nblack, Ind.)

South Korea—"Voice of the United Nations Command," 4.780, 2.5 kw., Pusan, operates around 0600-1700; headquarters are in Tokyo. (*Radio Australia*) HLKA, 7.935, Seoul, has improved signal 0530-0600. (Balbi, Calif.; Sanderson, Australia) *Armed Forces Korea Network*, 6.895A, is heard in Japan around 0700 at strong level. (JSWC)

Spain—Madrid, 9.363AV, is good level with *English* for Europe 1515-1545. (Joel Levy, N. Y.) *Radio Mediterraneo*, 6.994A, Valencia, good strength 1535 with native music; Valladolid, 7.006, fair to good 1535 with Spanish music; *Radio Falange de Leon*, 6.834, weak to fair 1650. (Cox, Dela.)

Spanish Guinea—Nattugglan, Sweden, says *Emisora de Radiodifusion Santa Isabel*, 7.200, Fernando Peo, is heard 1420-1500 sign-off; *English* at 1430.

Sweden—Radio Sweden, 11.705, Stockholm, is good level in N. Y. with *English* for Eastern North America 0700-0715, then has Swedish. (Joel Levy) Noted at good strength with news 0000, Swedish 0015, on 9.535. (Bulmur, Manitoba; Winch, Calif.) Good on this channel with news 1100.

Switzerland—HER6, 15.305, Berne, noted to Middle East 1230, good signal. (Joel Levy, N. Y.) Heard on 6.165, 9.665. 7.210 at 2215. (Waltz, Washington State) Good on 9.665 at 1350 with home news. (Hicks, Ga.) *United Nations Radio* heard over HBQ, 6.657A, with *English* weekdays 1330. (Guilbert, Germany)

Syria—Damascus, 9.555, still has *English* 1630-1730 closedown. (Pearce, England)

Tahiti—Radio Tahiti is scheduled 2300-2400 on 6.135, 7.025; 1700-1715 on 7.025, 7.125 in Tahitian; 0000-0200, 1717-1800 on 7.025, 7.125 in French. (Austrian DX-Club)

Tanganyika—Radio Dar-es-Salaam, 5.050, is heard in Sweden in Swahili at 1000-1100; has CWQRM, other interference. (Nattugglan)

Trinidad—VP4RD, 3.275, Port-of-Spain, noted with popular music 1835, considerable QRM, possibly from ZYR31, Baura, Brazil. (Cox, Dela.) Heard on 6.085 at 0500 with birthday greetings, fair level in Calif. (Balbi)

Turkey—TAV, 17.825, noted 0850 with dance music. (Pearce, England) TAT, 9.515, has improved signals on West Coast in *English* for North America 1815-1900. (Himber, Calif.) *English* for Europe 1600-1645 is now over TAS, 7.285, AP, 9.465. (Churchill, Va.; Arthurs, Pa.) TAZ, 6.600A, *Radio Izmir*, is heard in Britain 1400-1530. (ISWC)

USI (Indonesia)—YDF2, 11.785, Djakarta, noted at weak level 1400 with news for Europe; some QSB. (Cox, Dela.) YDF6, 9.710, noted at good level when ending *English* session 1030. (McDaniel, Idaho) Heard in *English* 0630-0700. (Gruenkorn, Calif.) And in Indonesian 0710 tune-in. (Riggle, Ohio) YDF7, 11.770, noted 2015 with Home Service program. (Sanderson, Australia)

USSR—Komsomolsk, 9.565, Siberia, noted in Home Service 0410; heard on 6.055 in native 0245. (Cox, Dela.)

Vatican—News at 1000 noted on 9.646, fair, and 11.685, poor. (Morgan, Calif.) Lists *English* 1000, 1315 over 7.280, 9.645, 11.685, 15.120; and Tuesday only 1100 on 11.685, 21.740; on Sunday 0335 has Gospel Homily in various languages over 6.030, 9.645. (Guilbert, Germany)

Yugoslavia—Radio Belgrade, 6.100, heard with news 1715-1730, good level in Va. (Saylor) And 1330-1345 in parallel over 6.100, 7.200. (Pearce, England) The *Central Amateur Station*, 7.416, is on the air daily now 0900-1030 with light music. (ISWL, England)

* * *

Press Time Flashes

The DX session, "Sweden Calling DX-ers!" has been discontinued by *Radio Sweden* "for budget reasons." Beginning this month there will be a special series of programs devoted to societies and certain groups of listeners each first Tuesday of the month at 1130, 1730, and on following Wednesday at 0215—all over 6.065. First program of January 4 is to be dedicated

New Secret Recorder



with Built-In Microphone and Playback Facilities

Available for the first time, a really secret and dependable tape recorder for your investigative work with full assurance of catching every word and whisper. Specifically designed for all forms of fool-proof sure-fire investigative work. Completely self-contained, operates anywhere!

Briefcase ingeniously camouflaged to open, without disclosing recorder in operation. In-built super-sensitive microphone plus new circuits record all sounds from a whisper to a roar. Picks up whispers at a distance of 12 feet and ordinary speech at 100 feet. Secret latch switch operates recorder. Provides 1½ hours of uninterrupted recording time. Built-in headphone playback. Tapes also play back on any 1½ ips recorder.

Available to all legitimate commercial, professional, industrial, municipal, state and federal investigative agencies.

SPECIAL INTRODUCTORY OFFER
Limited for sixty days. Price subject to increase afterwards without notice. **\$225.00**

AMPLIFIER CORP. of AMERICA
398 Broadway, N. Y. 13, N. Y.

EARN MORE MONEY— BE A PROFESSIONAL TELEVISION SERVICE TECHNICIAN



Get down-to-earth practical TV training with WTI experts for the top paying \$5,000-\$10,000 per year jobs.

UHF—COLOR—VHF SEND FOR **FREE**
Master the latest, up-to-the-minute TV and Color TV developments. **BOOK TODAY!**

WESTERN TV offers real experience on live equipment in our **BIG SHOPS AND LABORATORIES** in the shortest practical time under expert instructors. Graduates are in big demand because they have the "field experience" necessary for immediate "bench" or supervisory positions. You learn every phase of Radio and TV servicing (AM, FM, VHF, UHF). WTI men win fast promotion... can demand better pay... develop highly profitable businesses of their own with the latest and most **PRACTICAL PERSONALIZED TRAINING BEHIND THEM**. You concentrate all your time on being a **PROFESSIONAL TV SERVICE TECHNICIAN**—non-essential math and engineering theory omitted. **YOU CAN EARN WHILE YOU LEARN.** Special Finance Plan. **APPROVED FOR VETERANS.** Find out how you can get into the **TOP PAY GROUP**—Send for this fact-packed book NOW!

WESTERN TELEVISION INSTITUTE America's Leading Television Servicing School

Western Television Institute, Dept. R-124
341 W. 18th St., Los Angeles 15, Calif.
Without obligation, please send FREE fully illustrated booklet. (No salesman will call.)
NAME _____ AGE _____
ADDRESS _____
CITY _____ ZONE _____ STATE _____

January, 1955

to English-speaking members of the International Order of Goodtemplars. Arne Skoog, DX Editor of *Radio Sweden*, tells me, "In order to continue our contacts with our faithful DX-ers, a few minutes of the new program will be devoted to DX-ing each month. It is also hoped that our DX-ing friends will act as 'Radio Pilot' for these programs—that is, assist those to whom the program is aimed in tuning in the broadcast."

Cox, Dela., has noted a *new* station in Honduras testing on 6.085 at 0250 and asking for reports to HRNQ, Box 393, Tegucigalpa, Honduras; frequency given as 6.090 but was actually 6.085; signed off 0254. Balbi, Calif., notes the Japanese Home Service Stations, JKZ, 4.910, JKH, 7.257.5, and JKJ, 7.285, have (*English*) news now 0455-0500 sign-off (*daily except Sunday*).

Bucharest, Roumania, now uses 6.210 for *English* to North America 2200-2230, 2330-2400 (presumably replacing 6.143A); announces also 9.254, 9.570. (Ray, N. Y., others)

New QRA for WWV is National Bureau of Standards, Boulder Labs., Boulder, Colorado, USA. (Steve, Ill.) Anyone wanting a pen-friend overseas should write to World Youth Radio Magazine Pen Friends' Corner, Swiss Short-Wave Service, Neungasse 23, Berne, Switzerland. (Young, N. Y.) By this time, the 1955 Edition of *WORLD RADIO HANDBOOK* should be available from Gilfer Associates, Box 239, Grand Central Station, New York 17, New York; write direct to that QRA for order blank. *Radio Japan* uses JOA3, 9.695, JOB, 6.080, now to Western North America 0000-0100.

Voice of America verifies reception of all VOA transmitters from both continental United States and overseas relay stations from its *new* QRA of United States Information Agency, IBS/FN, 330 Independence Avenue SW, Washington 24, D. C., USA.

According to announcement, *Radio Peking's English* schedule now is 2200, 15.105, 15.060, 11.960, 11.690, 11.300, 9.660; 0400, 15.105, 15.060, 11.960, 11.300, 9.660, 700 kc., and 0930, 15.060, 11.690, 11.300, 9.660, 9.205, and 700 kc. (JSWC)

JOZ2, 6.055, and JOZ, 3.925, Tokyo, now have "Economic Program" in *English* 0250-0300 (instead of 0310-0320). Pyongyang, North Korea, signs on daily 0255, fair signal on 6.250A. USSR noted to Far East 0330-1000 now over 7.28, 6.143, 6.000, 7.280; Moscow to USA in *English* heard 2000-2100 on *new* 11.85, and to West Coast on *new* 6.180 at 0100-0200. Taipei, Taiwan (Formosa) is now using 6.095 parallel 11.92, 11.736 to Middle East 0230-0400; news 0230. (Balbi, Calif.)

* * *

Acknowledgement

Thanks for the FB cooperation during 1954, and may 1955 bring you much DX! Keep your reports coming to Kenneth R. Boord, 948 Stewartstown Road, Morgantown, West Virginia, USA. K.R.B.

To make a Good Rig Better

USE CANNON PLUGS

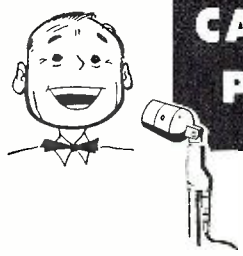

ABC, NBC, CBS and all radio and TV stations have used Cannon Plugs almost exclusively since they started... You can have the same high quality and dependability that spell satisfaction... in rig building and operation.

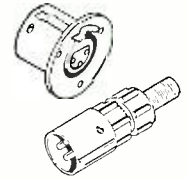

XL SERIES. With thumb pressure LATCHLOCK—no accidental disconnect. Mike and audio-connector; 3 or 4 contacts, seventeen complete assemblies. Standard on top quality mikes. Available through most radio jobbers.

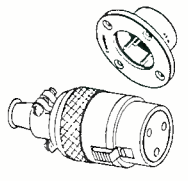

P SERIES. The old faithful—radio men swear by it, not at it. Thumb pressure LATCHLOCK, positive connection. Up to 8 contacts; steel plug shell. Ninety-nine complete assemblies for audio circuits and power.



UA SERIES. The RETMA specified standard weather-proof, gold plated contacts, spring insert removal. Thumb pressure LATCHLOCK.

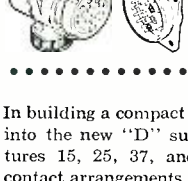

K SERIES. For power supplies, audio circuits and combined circuits. A great variety of shells and inserts.

In building a compact rig, look into the new "D" sub-miniatures 15, 25, 37, and 50-5a contact arrangements. They're really small. Likewise the "U" series—1-12 contacts. New XL Bulletin ready; also ask for RJC-7 with prices and list of our franchised distributors.



CANNON ELECTRIC



CANNON ELECTRIC CO., 3209 Humboldt Street, Los Angeles 31, Calif. Factories in Los Angeles, Toronto, East Haven. Representatives in principal cities. Please Refer to Dept. 145

WORLD'S LARGEST MANUFACTURER
OF CUSTOM BUILT TELEVISION

MATTISON

SILVER ROCKET 630 CHASSIS

• with **TUNEABLE** •

BUILT-IN BOOSTER
for Better DX Reception

Featuring **Synchromatic Tuning**

Tube
Complement:
28 tubes
3 rectifiers
1 CRT

Select Your
Channel . . .
**SOUND IS
AUTOMATIC!**

32

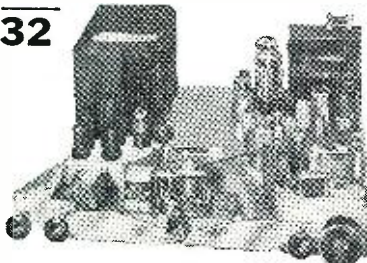

Tuneable Booster

- Broad band single knob control pre-amplifier built in to eliminate long leads which may cause regeneration and attenuation of signal.
- ONLY THE MATTISON 630 CHASSIS HAS AN ALL CHANNEL TUNEABLE BUILT-IN BOOSTER THAT INCREASES SIGNAL STRENGTH UP TO 10 TIMES.

Also Available The World Renown

- **MATTISON 630 SILVER ROCKET CHASSIS** without built-in booster.
- **MATTISON 630 SILVER ROCKET CHASSIS** with **BUILT-IN UHF TUNER**

ALL CABINETS MADE IN MATTISON'S OWN CABINET FACTORY. AVAILABLE IN EVERY FINISH AND STYLE. WRITE FOR COMPLETE CATALOG.

DEALERS! SERVICE MEN! . . . FREE!!
Write for Mattison's merchandising portfolio explaining the "UNASSEMBLED PLAN" and "\$1,000,000 FLOOR PLAN."



Manufactured with integrity

When you buy from Mattison you need only one source of supply! You can buy a Mattison Chassis, a Mattison Cabinet or a complete Mattison TV Set!

Mattison Television & Radio Corp.
10 West 181st St., Dept. RN, N. Y. 53, N. Y.

MORE JOBS than graduates

Demand for our engineering graduates exceeds supply. Effective placement. Study in this world-famed college established 1884. Quarters start March, June, Sept., Jan. Approved for Korean Vets.

Bach. Sci. degree in 27 months

Complete Radio Eng. courses . . . TV, UHF and FM. Also Mech., Civil, Elec., Chem., Aero. and Adm. Eng.; Bus. Adm., Acct. Small classes. Well-equipped labs. Modest costs. Prep. courses. Write Jean McCarthy, Director of Admissions for Catalog and Campus View Book.



TRI-STATE COLLEGE

1615 College Avenue, Angola, Indiana

NEW AUDIO EQUIPMENT

NEWCOMB AMPLIFIER

A new addition to the company's "Classic" series of home music equipment has been announced by *Newcomb Audio Products Company* of Hollywood, California.

The 20-watt "Ultra-Fidelity Classic 1500" amplifier includes the company's exclusive "Audi-Balance" which as-



sure minimum distortion for the life of the amplifier. As components and tubes age, the user merely pushes a button and distortion disappears.

Separate crossover and roll-off controls provide up to 36 different recording curves. New level and improved loudness control, a new rumble filter, seven inputs, a mike and tape input, and an output to tape all contribute to the improved efficiency of the amplifier. The "Classic 1500" includes the "Adjusta-Panel" feature which allows knob shafts to be "stretched" up to 3/4" for custom installations. The dial panel is removable.

Complete specifications on this amplifier are available on request.

STEREOPHONIC ADAPTOR

Binaural stereophonic reproduction is now available for classroom and home tape recorders by means of the new "Microadaptor" offered by *Dac-tron Distributing Company*, 104 Spruce Place, Minneapolis, Minn.

The new development utilizes the recently-released dynamic miniature high

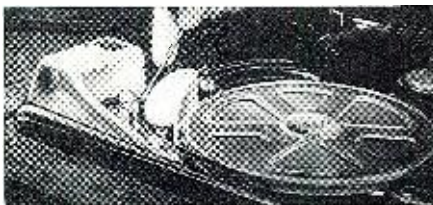

fidelity magnetronic record and playback tape pickups manufactured by the *Maico Company*. The *Dac-tron* unit contains four of the new pickup heads, two record-playback and two companion erase, with factory-sealed alignment for standard 1-17/32" binaural spacing.

The new "Microadaptor" can be installed in most home tape recorders in about 30 seconds using a screwdriver. A free brochure on the new unit is available from the company.

NEW TUBE FOR HI-FI

Tung-Sol Electric Inc. of Newark, New Jersey has developed a sturdy new double-power tube especially for audio circuit applications.

The new beam amplifier, 6550, measures 4 3/4" long and 2-1/16" in diameter. It features glass button stem construction, *Micanol* wafer and metal shell base, stable cathode materials, maximum control of grid emission due to gold plating and carbonizing, etc.

Under proper circuit conditions the new 6550 has double the power of the company's 5881 and requires approximately the same voltage drive. A pair of 6550's in push-pull will produce up to 100 watts. The two tube types, 5881 and 6550, are not interchangeable and circuit modification must be made.

For circuitry suggestions and technical data, write the Commercial Engineering Department of the company.

NEW TAPE EQUIPMENT

An entirely new drive and control concept has been incorporated in the newly-designed magnetic tape player and recorder line being marketed by *International Scientific Industries Corp.* of 3101 E. 42nd Street, Minneapolis 6, Minn.

The new equipment employs the company's "Tsimetric" magnetic differ-

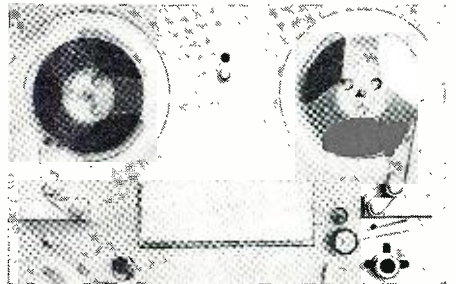

ential drive to operate the tape handling mechanism without frictional clutches or brakes. A single knob controls all reel motions. The drive is based on a multi-poled *Alnico VI* permanent magnet whirling freely between two drag cups and positioned axially by a sensitive feedback system. This automatically applies balanced relative torque to the reels for constant tape tension and continuously variable drive for editing and high-speed transport, as well as smooth, instant brake action.

For complete specifications and prices on the magnetic tape players and recorders which incorporate this new drive system, write Dept. KP of the company, mentioning this publication.

12-WATT AMPLIFIER

Rauland-Borg Corporation, 3515 W. Addison Street, Chicago 18, Illinois has introduced a new high-fidelity amplifier, the Model 1811.

The new unit features full 12 watts output with frequency response $\pm .5$ db 20 to 20,000 cps. The amplifier includes four inputs for magnetic pick-up, microphone, tape, and tuner; controls for input, bass, treble, and vol-

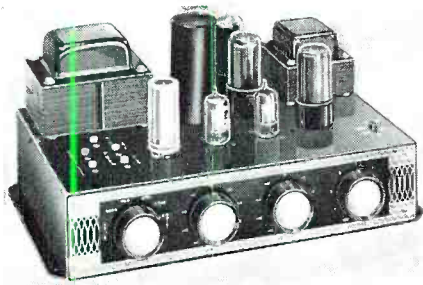

ume; and separate bass and treble tone controls, each with + 16 db of boost and 16 db of attenuation, calibrated in decibels. Three response curves are provided for *ffrr*, RIAA, and "quiet" (scratch reduction).

Full details on the Model 1811 are available from the manufacturer.

3-SPEED CHANGER

Fenton Company, 15 Moore Street, New York 4, New York is currently offering a line of "PE Rex" changers which have been imported from West Germany.

The new changer features a patented internix mechanism, mixing any standard or odd size records from 6 1/2" to 12" of the same speed. Three models are currently available: The "Rex A" has a reversible dual crystal cartridge and 3-stage tone control; the "Rex AM" has two easily interchangeable magnetic cartridges, a linear frequency response from 30 to 18,000 cps, and a 3-stage tone control; and the "Rex A Special" has two magnetic cartridges, built-in preamp, 3-stage bass boost, 3-stage noise suppressor, continuous variable speed regulation, and pilot lamp.

SIGNAL GENERATOR FOR AUDIO

Precision Apparatus Co., Inc. has announced a new basic test instrument, the Model E-300 sine-square wave signal generator, covering the

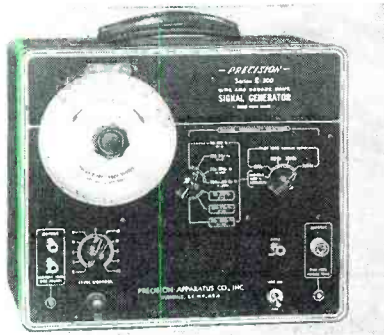

audio-video range. The instrument was especially developed to meet the need for a unit capable of handling electronic amplifier testing problems which cannot be handled with the usual complement of test instruments.

The Model E-300 provides accurate sine and square wave signals for di-

January, 1955

★ HIGHER INCOME! ★ LESS COMPETITION! ★ MORE SECURITY!

Get into two-way radio maintenance—with FCC license and LAMPKIN meters!



LAMPKIN 205-A FM MODULATION METER

Direct indication of peak voice deviation, 0-25 kc. positive or negative. Tunable 25-500 mc. in one band. Doubles as relative field-strength meter. Built-in speaker. Jack for oscilloscope. Weight 13 lbs., width 12". \$240.00.

LAMPKIN 105-B MICROMETER FREQUENCY METER

Uses one crystal to measure all transmitters from 0.1 to 175 mc., and crystal-controlled transmitters to 500 mc. Gives readings of percent error from assigned frequencies. Acts as pinpoint CW source for receiver final alignment. Weight 13 lbs., width 13". \$220.00.



FREE! New booklet "HOW TO MAKE MONEY IN MOBILE-RADIO MAINTENANCE!" For your copy—plus complete technical data on Lampkin meters—mail coupon today!



LAMPKIN LABORATORIES, INC.
Bradenton, Florida

LAMPKIN LABORATORIES, INC.
MFM Division, Bradenton, Florida

At no obligation to me, please send
 Free booklet Technical data

Name _____

Address _____

City _____ State _____

Easy, fast
way to cut
"Key" and "D"
openings
in chassis



...with new GREENLEE Radio Chassis Punches



No. 732 "Key" Punch



No. 733 "D" Punch

Now, in 1 1/2 minutes or less make perfect "Key" or "D" holes for sockets and other equipment. Simply insert GREENLEE Punch and turn with an ordinary wrench . . . get a "clean" opening in a hurry! Write today for details on these as well as GREENLEE Radio Chassis Punches for round and square openings. Greenlee Tool Co., 1881 Columbia Ave., Rockford, Illinois



LEARN

Television-Radio
Electricity
REFRIGERATION-ELECTRONICS
IN THE GREAT
SHOPS OF **COYNE**

TRAIN QUICKLY! OLDEST, BEST EQUIPPED SCHOOL of ITS KIND in U.S.

Come to the Great Shops of Coyne in Chicago. Get practical training in opportunity fields—TELEVISION-RADIO—ELECTRICITY—ELECTRONICS—vital in Defense Program. Prepare now for a better job in industry or better service rating.

Approved for Veterans

Finance Plan—Enroll now, pay most of tuition later. If you need part-time work to help out with living expenses while at Coyne, we'll help you get it. Special tuition plan for men of Draft Age.

FREE BOOK Clip coupon for Big Free Illustrated Book. No salesman will call. Act NOW.

B. W. Cooke, President
COYNE SCHOOL A TECHNICAL TRADE INSTITUTE CHARTERED NOT FOR PROFIT
Established 1899
500 S. Paulina, Chicago
RADIO ★ REFRIGERATION ★ ELECTRONICS

B. W. COOKE, Pres.
COYNE School
500 S. Paulina St., Chicago 12, Ill. Dept. 15-85H

Send FREE BOOK and full details on:
 TELEVISION-RADIO ELECTRICITY

NAME _____

ADDRESS _____

CITY _____ STATE _____

CRYSTALS

Do you know?

We are the largest surplus crystals company selling NOVICE CRYSTALS in steps of 1 kc.

ALL CRYSTALS TESTED FOR ACTIVITY! 1-DAY SERVICE FOR EVERYTHING IN STOCK!

NOVICE BAND FT-243 FUNDAMENTAL FREQUENCIES

Lots of 10 or more. Ea... **99c**

Individually. Ea. \$1.25
YOUR CHOICE OF FREQUENCIES!

80 METERS

3701, 3702, 3703 through 3748 in steps of 1 KC.

40 METERS

7176, 7177, 7178 through 7198 in steps of 1 KC.

DOUBLING TO 40 METERS:

3588, 3589, 3590 through 3599 in steps of 1 KC.

The new trend!

SINGLE SIDE BAND

We have complete stock of FT-241-A for Lattice Filter.

FT-241-A
Low Frequency Crystals
79c

Lots of 10 or more. Each.... 79c
Lots of 5 or more. Each.... 89c
Individually. Each..... 99c

400	446	453	459	466	474
440	447	454	461	468	475
441	448	455	462	469	476
442	450	456	463	470	477
444	451	457	464	472	479
445	452	458	465	473	480

NOTE: Minimum order: \$2.50. All orders must be accompanied by check, cash or money order WITH PAYMENT IN FULL. No C.O.D. Include approximately 5c per crystal for postage. Indicate second choice frequencies wherever substitutions may be made. Calif. buyers add tax.

SEE OUR ADS!

Dec/54 RADIO & TV NEWS. Page 137
December, 1954 C.Q.
For COMPLETE LIST of types of crystals, frequencies and prices.
Ask for FREE Crystal Catalogue!

U. S. CRYSTALS, INC.

805 S. Union Ave. Los Angeles 17, Cal.

rect performance testing of high-fidelity audio amplifiers, TV audio amplifiers, carrier-current systems, and other wide-range devices.

The generator provides continuous coverage from 20 cycles to 200 kc. in four bands on its sine-wave ranges and 20 cycles to 20 kc. in three bands on its square-wave ranges.

The company, at 92-97 Horace Harding Blvd., Elmhurst L. I., New York, will supply full details on request.

ELECTRONIC ORGAN KIT

Electronic Organ Arts, Box 41084, Los Angeles, California has recently introduced a new "home" model organ kit which is compact enough to be used in the average house.

The kit includes chassis, manuals, and pedals which can be assembled by anyone handy with tools. When com-



pleted, the kit can be mounted in a pre-sanded, ready-to-finish console cabinet.

The tone-generating system consists of vacuum-tube oscillators keyed from the manuals, tone-shaping circuits controlled by standard organ stops, and a hi-fi amplification system.

The firm's line of kits also includes attachments for existing pipe and electronic organs for adding more stops to instruments lacking in tonal variety. Organ components and parts can be purchased individually or in groups as time and budget permit.

An illustrated parts and instruction catalogue is available for 25 cents.

NEW "MINIFON" RECORDER

A new pocket-sized "Minifon" wire recorder that permits up to 2½ hours of continuous recording on one spool has been introduced by *Interstate Photo Supply Corp.*, 28 W. 22nd Street, New York 10, New York.

The unit operates on a *Mallory* 9-volt mercury battery, a 30-volt hearing aid battery and has a 1½-volt penlite-operated amplifier. It is equipped with crystal microphone, "Stetoset" earphone, and a 1½-hour spool of wire. Fifteen minute to 2½-hour spools, as well as an a.c. power supply pack, are available as accessories.

NEW AUDIO LINE

Sightmaster Corp. of New Rochelle, New York has entered the audio field with a line of speakers and systems.

The first unit in the line is the deluxe system, Model X-100, consisting

RECORDING TAPE (Plastic Base) 40% OFF (NEW)

- 1200 ft. plastic tape with plastic reel included.
- Each reel individually boxed.
- Choice of nationally famous top quality brands such as:
Reeves (SPN-12) 3.20; Audio (1251) 3.25; Scotch (111-A) 3.25; Encore 3.25; Irish, Professional grade (211) 3.30.
- FREE! A 7.95 tape carrying case included with purchase of 12 new tapes!

★ ★ ★ ★ ★ USED RECORDING TAPE (PLASTIC BASE)

ATTENTION: Radio Stations, electronic calculators, Industrial users: We have the new 1½ or 2 mil mylar, "sound-plate," "lifetime," or "H.O." tapes and we will buy or exchange your present 1 mil mylar or plastic tapes.

1.99 for 7"—1200 foot
.99 for 5"—600 foot
.59 for 4"—300 foot
.29 for 3"—150 foot

★ ★ ★ ★ ★ USED "MYLAR" TAPE (1 Mil)

(Impact Strength 9 Times Greater Than Plastic Tape)

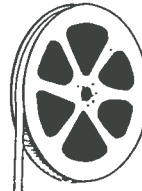

1200 ft. (7" reel)... 2.59
1800 ft. (7" reel)... 3.89

New empty plastic reels in boxes for easy labeling. 3" 10c; 4" 22c 5" 24c; 7" Professional reel (2½" hub) 25c ea. EMPTY BOXES: 3" 3c; 4" 5" 7" 5c ea.

We carry all brands of new tape, recording blanks, tape recorders, etc. at low prices. PLEASE INCLUDE SUFFICIENT POSTAGE.

COMMISSIONED ELECTRONICS CO.

2503 Champlain St. N.W. Washington 9, D. C.

ENJOY 3 COLOR TELEVISION FILTER SCREEN NOW

Changes dull eye-straining black and white pictures into beautiful color tones. Seconds to attach. No tools used. Helps eliminate glare. Order direct. Send \$1 for screen size up to 16", \$1.25 size 17", \$1.50 size 20", \$2 size 21", \$2.50 size 24", \$3 size 27". We pay postage except on C.O.D. orders. Satisfaction guaranteed. Inquiries from dealers also welcomed. Zingo Products, Johnstown 19, New York



BARGAIN HUNTING?
RADIO SERVICEMEN!
Write for SENSATIONAL CATALOG
HENSHAW RADIO SUPPLY
3619 TROOST KANSAS CITY, MO.

When you order by mail . . .

please print your name and address clearly, be specific in your order, enclose proper amount, allow ample time for delivery.

RADIO ENGINEERING DEGREE IN 27 MONTHS

Radio engineering is a big field. There's room for you in it—if you're good. Get first-class training at Indiana Tech. Intensive, specialized course, including strong basis in mathematics and electrical engineering, advanced radio theory and design, television, electronics. Modern laboratories. Low rate. Also B.S. DEGREE IN 27 MONTHS in Aeronautical, Chemical, Civil, Electrical and Mechanical Engineering. (G.I. Government approved. Enter March, June, September, December. You can earn part of your expenses right here in Fort Wayne while you are studying.)

INDIANA TECHNICAL COLLEGE

915 E. Washington Blvd., Fort Wayne 2, Indiana
Please send me free information on B.S. Engineering Degree in 27 months as checked.

- Radio-Television Aeronautical
 Civil Mechanical Electrical

Name
Address

RADIO & TELEVISION NEWS

of a 15" woofer, a special horn tweeter, and a crossover network. The woofer consists of a 5-pound magnet and has a 2.1-inch voice coil. It will deliver lows down to 25 cycles and provides extended bass response without distortion and use of the bass-boost control of the amplifier.

The tweeter unit combines both direct-radiator and compression-type action. The horn is actually a flare for wide dispersion and operates on a low pressure air column. The throat diameter of the horn corresponds to the piston diameter of the diaphragm.

NEW ENCLOSURE LINE

Cletron, Inc., 6611 Euclid Avenue, Cleveland 3, Ohio is now offering a new line of 15" and 12" console enclosures, an 8" table model, and 5", 6", 8", 10", and 12" custom wall baffles.

Each model is available in modern blonde or mahogany finish cabinets, sound-engineered to provide richness and clarity of musical tones. The special speakers are acoustically matched to the cabinet design as follows: 15" coaxial speaker with aluminum voice coil, built-in crossover network, and a high-frequency control to turn off the tweeter when desired.

The 12" speaker has aluminum voice coil form and frequency response of 30 to 16,000 cps. The 8" extended range speaker has a response of 50 to 16,500 cps.

A 4-page descriptive brochure is available on these new units.

AM-FM TUNER KIT

Approved Electronic Instrument Corporation, 928 Broadway, New York 10, New York is now marketing a new 12-tube AM-FM tuner in kit form, direct to consumers.

The AM tuning range is 530 to 1650 kc. while FM coverage is from 88 to 108 mc. Sensitivity is 5-10 μv ., 20-30 db. The unit has a bandwidth of 200

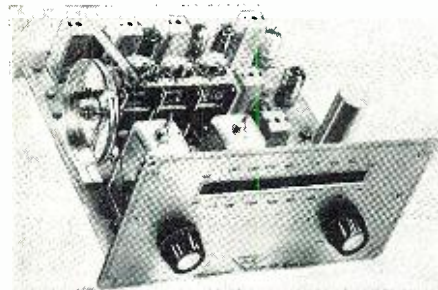

kc., tuned r.f. stages, two limiters and discriminator. The chassis dimensions are 9 $\frac{3}{4}$ " long by 5" high, by 8" wide.

The kit comes complete with all parts, tubes, and pictorial and schematic diagrams. For further details on the "Imperial V," write the company direct.

12" TURNTABLES

Rek-O-Kut Company, 38-01 Queens Blvd., Long Island City 1, New York has added a new model to its "Rondine" turntable line.

The "Rondine Jr." is designed for

8 MASTERPIECES \$1.00

LONG-PLAYING (33 $\frac{1}{3}$ R.P.M.) HI-FIDELITY
NOT \$1.00 EACH!—BUT \$1.00 FOR ALL EIGHT!



Long
Playing

No Strings

Attached! No Need to Buy Any

Other Records Ever! Full Advantages of Trial Membership

ALL 8 masterpieces for only \$1. Performed by world-famous artists. Custom-recorded on purest vinyl. Reproduced with a tonal fidelity encompassing the entire range of human hearing (50 to 15,000 cycles.) This amazing offer is made only to demonstrate superb quality of our recordings; and to show you advantages of trial membership.

HOW CLUB OPERATES—We advise you monthly of new releases. Those you want are sent you for FREE trial. After 5 days' listening—only the records you decide to keep are billed you at the low membership price of \$1.50 per disc (average playing time 40 min.). You save $\frac{2}{3}$ the usual retail price! This "give-away" offer can obviously not be kept open indefinitely. MAIL COUPON NOW while supply lasts. Full money-back guarantee.

SCHUBERT
"Unfinished" Symphony (No. 8)
BEETHOVEN
Ruins of Athens (March and Choir)
MOZART
Piano Concerto in E Flat
BACH
Tocatta and Fugue in D Minor
WAGNER
Die Meistersinger Prelude, Act 1
MOUSSORGSKY
Night on Bald Mountain
BRAHMS
Academic Festival Overture
DUKAS
Sorcerer's Apprentice

The Musical Masterpiece Society, Inc., Dept. 471
43 West 61st Street, New York 23, N. Y.

Enclosed is \$1 in full payment for the recordings of 8 masterpieces listed. Enroll me as trial member. Privileges: No purchase obligation ever! Advance notice of releases. 5 day free trial on any discs. I may reject records before or after receipt; may cancel membership at any time. For future 1-p. discs I keep, I'll pay only \$1.50 each plus shipping.

Name.....
Address.....
City.....State.....
Canada, address: 686 Bathurst St., Toronto 4, Ont.

AUDELS TV-RADIO SERVICE LIBRARY

HERE IS LATE INFORMATION IN A HANDY FORM FOR RADIO AND TELEVISION REPAIRMEN, SERVICEMEN AND STUDENTS

2 VOLS. \$6 COMPLETE \$1 A MONTH PAY ONLY 1 MO.

AUDELS T.V.-RADIO SERVICE LIBRARY—Highly Endorsed—1001 Facts—Over 1552 Pages—625 Illustrations, Diagrams of Parts. Presents Important Subjects of Modern Radio, Television, Industrial Electronics, F.M., Public Address Systems, Auto, Marine & Aircraft Radio, Phonograph Pick-Ups, etc.

IT PAYS TO KNOW!
The Basic Principles—Construction—Installation—Operation—Repairs—Trouble Shooting. Shows How to get Sharp, Clear T.V. Pictures, Install Aerials—How to Test. Explains Color Systems, Methods of Conversion, Terms, etc. Includes Ultra High Frequency (U.H.F.)—Valuable for Quick Ready Reference & Home Study. Tells How to Solve T.V. & Radio Troubles—Answers Your Questions.

Get this Information for Yourself.
7 DAY TEST—ASK TO SEE IT!

MAIL ORDER
AUDEL Publishers, 49 W. 23 St., N.Y. 10, N.Y.
Mail AUDELS T.V. RADIO SERVICE LIBRARY 2 Vols. \$6 on 7 days free trial. If O. K. I will remit \$1 in 7 days and \$1 monthly until \$6 is paid. Otherwise I will return them.

Name.....
Address.....
Occupation.....
Employed by.....RN

!!! CHECK EVERY ITEM !!!

WHOPPING VALUES FOR EVERYONE!!

G.E. METER FRAME & GLASS... 2 $\frac{3}{8}$ " I.D., 1-3/16" behind panel. All bakelite...
Type DO-71-31 $\frac{1}{2}$ " O.D..... each \$1.49
Type "A"-3" O.D. (narrow flange)—ca..... .98

CO-AXIAL ANGLE PLUG M-859 (83-1AP) ea. 29c..... .10 \$2.50
DPDT BAT TOGGLE SWITCH (C-H #8715K2) 20A/125V. Screw lugs: spring return... 62c..... .10 5.00
CABINET DRAW SLIDES: Hvy. duty, all-steel; silent ball-bearings. 1 $\frac{1}{2}$ " overall (3" extension). Cut metal finish..... pair 2.39
CRYSTAL MIKE (1 $\frac{3}{4}$ "x $\frac{3}{4}$ " deep)..... Hi-impedance, rubber shock mtd. Excellent replace. unit..... 1.29
HAND MIKE CASE..... moulded black bakelite. 2" I.D. Rubber mouthpiece—ca. 69c, 3/ 1.98

!! MOTOR SPECIALS !!

1/10 H.P. AC MOTOR (Oster #KS-687) 172 $\frac{1}{2}$ RPM: 2.8 Amps. 115V. 60 cy. Shaft 1" x 3 $\frac{1}{8}$ " O.D. Fully enclosed. 7" L. x 4 $\frac{1}{2}$ " O.D. (shpg. wt. 4 lbs.)..... \$7.95
1/17 H.P. G.E. MOTOR (Type S1)..... 1725 RPM. 7 amp. Dble. 3 $\frac{1}{2}$ " shaft. 110VDC. 4 $\frac{3}{4}$ " x 5 $\frac{1}{2}$ " L. (shpg. wt. 13 lbs.)..... 3.95

HEAVY DUTY RECORDING MOTOR (RM-4 type)..... 115 VAC. 4 pole. Silent operation. IDEAL FOR TAPE, WIRE or DISC. 5/16" shaft. Overall: 3 $\frac{3}{8}$ " sq. x 2 $\frac{3}{4}$ " deep. Less mtg. plate asshly..... \$4.95

!! WHAT A BUY !!

JUMBO RADIO-ELECTRONICS PARTS KIT
Check-full of new & surplus Radio, TV & Electronics Components WORTH SEVERAL TIMES THE PRICE!
17 full lbs. of: SWITCHES, CONTROLS, SOCKETS, WIRES, PHOTOFACTS DIAGRAMS, RESISTORS, CONDENSERS. PUSH DOZENS OF OTHER ITEMS. (shpg. wt. 20 lbs.)..... \$3.95

! HEARING AID PARTS !

HEARING AID AMPLIFIER CHASSIS (2 tube) Ready-wired..... \$2.49
VEST POCKET RADIO or AMPLIFIER adding only simple tuner & phone. WITH SCHEMATICS FOR A 2 or 3 TUBE SET. Less tubes & case..... 2.98
SET OF 2 SUB-MINIATURE TUBES FOR ABOVE PERMEABILITY BROADCAST TUNER..... 1.29
HEARING AID BONE CONDUCTION RECEIVER (1 $\frac{1}{2}$ "x $\frac{3}{4}$ "x1 $\frac{1}{2}$ ")..... Makes sensitive MUSICAL CONTACT MIKE. DETECTING, etc. Low impedance, magnetic..... 1.98
HEARING AID CORD..... 2 wire twisted, 17-16" O.D..... .05 ft.

EOTONE RADIO CORP.
67 Day Street
New York 7, N. Y.

A.... Always
B.... Buy
C.... Columbia

**NEW SHIPMENT! NEW ITEMS!
 NEW LOW PRICES!**

6C-457 COMMAND TRANSMITTER: 4-5.3 MC. Brand new, original box. Special, \$10.95
 Q-5 ERS: COMMAND 190-550 KC. RECEIVER: Excel. cond. Checked out. Each..... 12.50

SEE OUR AD DEC/54 Radio TV News for complete list of COMMAND EQUIPMENT.

McELROY CODE MACHINE: Complete with Wincalston perforator. New in overseas pack. 3-piece set..... \$19.95
 TG-10 CODE KEYS: Push-pull 6L6 amplifier, variable speed. Complete with tubes and reel. Approx. wt. 65 lbs. Excellent cond..... 14.95
 TG-34 CODE KEYS: Used, \$14.95; New..... 24.50

DUAL VOLTAGE GENERATOR

Operates @ 2700 rpm. Output voltage 14 VDC @ 25 amps, 1000 VDC @ 350 ma. New in overseas pack..... \$14.95
 R-150/CRW RECEIVER: 65-92 MC. Complete with dynamotor and 10,000 ohm relay. New, boxed..... 4.95

I-83 DYNAMOTOR TEST SET

12 or 24 V. Has 5 matched 3" meters: 0-35 VDC; 0-2 VAC; 0-10 amps DC; 0-500 VDC; 0-250 MA DC. Plus good variety of switches and other components. Excellent condition. LOW PRICE SPECIAL..... \$14.95

J-38 TELEGRAPH KEY: New, boxed. En..... 85c
 SPARK PLUG SUPPRESSORS FOR YOUR MOBILE RIG: 6 for..... 75c; 8 for..... \$1.00
 Continental 10,000 ohm wire wound.

COMMUNICATIONS RECEIVER

Model AR6. Freq. range: 190-9050 Kc. Complete with all tubes but less 24 V. dyn. Excel. cond..... \$14.95
 OHMITE RHEOSTAT MODEL K: 100 V. 500 ohm. New, boxed..... \$1.49

TRANSFORMERS

New! Boxed: 10 V. 60 cycle. 375-0-375 @ 250 ma. 5 V. @ 4 amps. 9 V. @ 5 amp..... \$4.95
 200-0-200 @ 20 ma. 5 V. @ 2 amp. 6.3 V. @ 1 amp..... 49c
 2.5 CT-2.5 CT. 5 amp each winding. 95c
 6.3 V. CT. @ 5 amp..... \$2.95
 TUBE TESTER PLATE & FILAMENT TRANSFORMER: Used in I-177. Multi-tapped for all voltages..... \$3.95
 VIBRATOR TRANSFORMER: 6-12-24 V. with 200 cycle vibrator. 120 V. @ 150 ma; 120 V. @ 150 Ma; 11 V. @ 430 ma..... 98c

RT-48/TPX-1 TRANSMITTER-RECEIVER Provides identification for aircraft using the IFF Mark III system. 17 tubes. Contains HF mixer. IF-RE adjustment for peak video receiver oscillator. Like new in carry case. with schematic..... \$14.95

TOP-SSS BUYS IN METERS!

HALLICRAFTERS "5" CARRIER LEVEL METER: 3" round. 0-5 mil. basic movement. DE over 50. New, boxed..... \$5.95
 SIMPSON METER: 3" round. 0-15 mil. New, boxed..... \$3.95
 0-2 AMPS. DC. 3" round. New, boxed..... \$2.95

NEW FREE BULLETIN! Get Your Copy Today!

NOTE: All items subject to prior sale and change of price without notice. 25% deposit required on ALL orders, balance C.O.D. Minimum order: \$20.
 SEND FOR NEW FREE CATALOGUE!

ELECTRONICS
 Columbia 2251 W. WASHINGTON BLVD.
 LOS ANGELES 18, CALIFORNIA

FOR
**The Finest
 MASTER
 AMPLIFIED
 AND
 COMMUNITY TV
 ANTENNA SYSTEMS-**
 - Send Us Your Problem for
 FREE Engineering Advice.

FREE: Important Technical Manual for Community and Master TV Systems
 FIELD STRENGTH METER, operates both on Battery and AC... \$89.

Write today to:
TRANSVISION, INC. NEW ROCHELLE, N. Y.

two-speed operation exclusively, 33 1/2 and 45 rpm. The new, low-cost unit employs the company's floating idler, a form of mechanical filtering which virtually eliminates acoustical coupling between motor and turntable.

The unit is driven by a 4-pole induction motor. Other special features include a built-in retractable hub for 45 rpm records and a permanently affixed strobe disc for instantaneous speed checking. The turntable is made of cast aluminum.

ESPEY AUDIO LINE

Espey Manufacturing Co., Inc. 530C E. 72nd Street, New York 21, New York is currently marketing a line of hi-fi equipment which includes the deluxe Model 710 receiver, the Model 700 tuner, and the Model 501 amplifier.

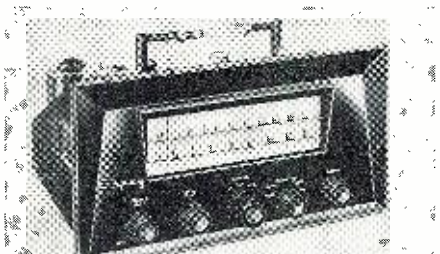

The Model 710 is single-chassis mounted incorporating a 12-watt Williamson-type amplifier, with an integral control panel for ease of installation. The tuner and amplifier are designed to be used together or with any other standard audio system. The 700 and 710 use limiter-discriminator circuits. The Model 501 is a 24-watt Williamson-type audio amplifier.

EXTENDED-RANGE SPEAKER

The Electronics Department of General Electric Company, Syracuse, N. Y. has announced the immediate availability of a new 8" extended-range loudspeaker which is being marketed as part of the firm's high-fidelity system.

Patterned after the company's 12" extended range speaker, the new Model 850 is recommended for use in low-cost hi-fi systems, as an extension speaker for hi-fi systems, or for use in modernizing radios and phonographs.

The speaker uses a 6.8 ounce, Alnico V magnet, has a power rating of 15 watts, and a response up to 12,000 cps. It is equipped with an aluminum voice coil.

PORTABLE SOUND SYSTEM

Mark Simpson Mfg. Co., Inc., Long Island City, N. Y., has introduced a new low cost portable sound system. Self-contained and weighing less than 20 pounds, it uses a 6-watt amplifier that contains a tone control and 4- and 8-ohm speaker taps. Frequency response is 50 to 12,000 cps. Model CS-6P-3 includes carrying case, 8-inch speaker, crystal microphone, and 3-speed manual phonograph in addition to the amplifier. Model CS-6 is available without the phonograph.

F.C.C. LICENSE

Get Your FCC Commercial Operator License Quickly

We specialize in rapid and thorough preparation for FCC examinations. Correspondence or resident training. Results guaranteed. Write for free booklet.

GRANTHAM School of Electronics

Dept. 103-D, 6064 Hollywood Blvd., Hollywood 28, Calif.
 (Phone HO 2-1411)

CODE SENDING SPEED
CODE RECEIVING SPEED

Be a "key" man. Learn how to send and receive messages in code by telegraph and radio. Commerce needs thousands of men for jobs. Good pay, adventure, interesting work. Learn at home quickly through famous Candler System. Quality for Amateur or Commercial License. Write for FREE BOOK.
CANDLER SYSTEM CO.
 Dept. 2-A, Box 928, Denver 1, Colo., U.S.A.

RADIO and TELEVISION ELECTRONICS



in all Technical Phases
 New Classes (Day and Evening) Start 1st of Dec., Mar., June, Sept.

Free Placement Service for Graduates For Free Catalog write Dept. RN55

RCA INSTITUTES, INC.

A Service of Radio Corporation of America
 350 WEST 4TH ST., NEW YORK 14, N. Y.

TAPE SALE

WESCOTT NEW PLASTIC RECORDING TAPE

1200' roll (in boxes) \$1.65 6 rolls \$9.50
 Also Milar 1 mil tape 1800' roll \$4.65 each
 EXCESS POSTAGE REFUNDED
 MONEY BACK GUARANTEE

WESCOTT TAPE

P. O. Box 1153, Dept. R, Columbus, Georgia

SAVE MONEY... MAKE MONEY...

LEARN TV

the practical way...

17", 21" and 27"

ASSEMBLE A
TRANSVISION TV KIT

Pay as You Wire \$ **39**
 Down Payment

WE WILL HELP YOU to start learning TV the practical way —by assembling a TRANSVISION TV KIT in EASY STAGES. For only \$39 you get PACKAGE #1 (standard first pkg. for all of our kits). This package gives you the BASIC CHASSIS and over 450 TV COMPONENTS with complete instructions, Drawings, Photos, and Service Booklet. When ready, you order the next stage (pkg. #2), etc. Low prices make your complete kit a terrific buy.



Shows 6 Great TV Kits:

EXCLUSIVE: Only Transvision TV Kits are adaptable to UHF. Ideal for FRINGE AREAS. No Previous Technical Knowledge required. Write now!

FREE CATALOG

TRANSVISION
 THE OLDEST NAME IN TV KITS

NEW ROCHELLE, N. Y.

MAIL THIS COUPON TODAY

TRANSVISION, INC., NEW ROCHELLE, N. Y. Dept. RN-1

I'm enclosing \$_____ deposit. Send standard kit PACKAGE #1, with all Instruction Material. Balance C.O.D.
 Send FREE copy of your new TV Kit Catalog.

Name _____
 Address _____
 City _____ State _____

Within the Industry
(Continued from page 26)

Francisco . . . **GENERAL ELECTRIC COMPANY** has established a new communication equipment center at Douglas and Broadway in Redwood City, California . . . **UNITED TRANSFORMER COMPANY** has established warehousing facilities for its line at 1865 North Western Avenue, Los Angeles, California . . . **UNITED ELECTRONIC SUPPLY COMPANY** has moved to new and larger quarters at 181 West End Avenue in New York City . . . **ALPRODCO, INC.** is building a new fireproof factory that will add 50,000 feet of floor space to its present facilities in Mineral Wells, Texas. This is part of the tower manufacturer's continuing program of expansion at all three of its plants . . . **WALCO PRODUCTS, INC.** has expanded into an additional building in East Orange, N. J. to increase production facilities for its line of record spray and protective sleeves for records . . . **GRAYSON CONTROLS DIVISION** has completed a new plant in Long Beach, California . . . **ROHN MANUFACTURING COMPANY** has acquired enlarged manufacturing facilities at 116 Farmington Road in Peoria. This is the company's third plant.

* * *

FRANK M. HOLLIDAY has been named field lecturer for the sales engineering department of *Raytheon's* television and radio operations.



He will conduct a nationwide series of forums, open to all television retailers and service technicians, which will cover every phase of the TV dealer and servicing operations.

Prior to joining *Raytheon*, Mr. Holliday was owner-manager of the *F. M. Holliday Co.* and was formerly manager of field personnel for the *Bendix* home appliance division.

The itinerary of the lecture series is not completed as yet, but will be announced later.

PHOTO CREDITS

Page	Credit
45	Radio Corporation of America
54	Regency Division, I.D.E.A.
64, 65	Wireless World
66	Motorola, Inc.
74	Electronic Instrument Co., Inc.

ERRATUM

In the parts list accompanying the article, "The 'Globe Scout'," which appeared in the December, 1954 issue, page 54, the following corrections should be noted: C₂₄, C₂₅— $.008 \mu\text{fd}$. should be $.0008$. Also, RFC₁, RFC₂—5 mhy. should be 2.5 mhy. and V₁—6F6 tube should be 6V6 tube.

For QUALITY - PERFORMANCE - DEPENDABILITY

Rad-Tel Tubes Guaranteed 1 FULL YEAR

70% to 90% OFF

- Same Day Service
- All Tubes Individually Boxed
- 300 Types Always in Stock



Type	Price	Type	Price	Type	Price	Type	Price	Type	Price	Type	Price
OA2	.74	5T4	.79	6C5	.39	7A8	.68	12H6	.56	35C5	.51
OA4	.68	5U4G	.55	6C6	.58	7AD7	.79	12J5	.42	35L6GT	.51
OB2	.81	5U8	.75	6CB6	.54	7AF7	.53	12J7	.49	35W4	.47
OC3	.72	5W4GT	.50	6CD6	1.11	7AG7	.69	12K8	.59	35Y4	.54
OD3	.70	5Y3GT	.37	6CF6	.64	7AH7	.79	12Q7	.59	35Z3	.59
OZ4M	.65	5Y4	.51	6CS6	.51	7B4	.44	12S8GT	.52	35Z4	.47
1A5	.49	5Z3	.45	6D6	.59	7B5	.45	12SA7GT	.65	35Z5GT	.47
1A7GT	.47	6A6	.51	6E5	.48	7B6	.69	12SC7M	.63	36	.39
1A2	.62	6A7	.69	6F5GT	.39	7B7	.49	12SF5	.50	36	.39
1B3GT	.73	6A84	.44	6F6	.59	7C4	.59	12SF7	.51	45	.55
IC5	.43	6AC5	.69	6G6	.42	7C5	.69	12SJ7M	.67	45 (Spec)	.27
IE7	.29	6AC7M	.86	6H6GT	.41	7C6	.59	12SK7GT	.63	45Z5	.49
IG6	.24	6AF4	.90	6J5GT	.43	7E5	.59	12SL7GT	.57	46	.69
IH4	.30	6AG5	.56	6J6	.52	7E6	.30	12SN7GT	.52	50A5	.55
1H5GT	.49	6AG7M	.99	6J7	.43	7E7	.59	12SQ7GT	.56	50B5	.52
1L4	.46	6AH4	.57	6K5	.47	7F7	.79	12SR7M	.49	50C5	.51
1LA4	.59	6AH6	.73	6K6GT	.45	7F8	.79	12V6GT	.46	50L6GT	.61
1LA6	.69	6AJ5	.65	6K7	.44	7G7	.89	12X4	.38	50K6	.49
1LB4	.69	6AK5	.55	6L6	.64	7H7	.59	14A4	.69	50V6	.49
1LC5	.59	6AK6	.59	6L7M	.68	7J7	.79	14A5	.59	50Y7	.50
1LC6	.79	6AL5	.42	6N7M	.63	7K7	.69	14A7	.63	50Y7	.50
1LD5	.59	6AM8	.78	6Q7	.45	7L7	.59	14AF7	.59	55	.49
1LE3	.59	6AQ5	.50	6R7	.69	7N7	.69	14B6	.63	56	.49
1LG5	.69	6AQ6	.37	6S4	.48	7Q7	.66	14B8	.63	57	.58
1LH4	.69	6AQ7	.70	6S7M	.79	7R7	.89	14C5	.79	58	.60
1LN5	.59	6AR5	.45	6S78	.90	7S7	.79	14C7	.79	70L7	.97
1NSGT	.67	6AS5	.50	6S8GT	.53	7V7	.89	14E6	.75	75	.49
1P5GT	.57	6AS6	1.49	6SA7GT	.55	7X6	.54	14E7	.88	76	.44
1Q5GT	.58	6AT6	.41	6SD7GT	.41	7X7	.70	14F7	.65	77	.57
1R5	.62	6AU4GT	.68	6SF5GT	.46	7Y4	.69	14F8	.69	78	.47
1S4	.59	6AU5GT	.82	6SG7GT	.41	7Z4	.59	14H7	.59	80	.43
1S5	.51	6AU6	.46	6SH7GT	.49	12A6	.54	14J7	.30	80V	.48
1T4	.59	6AV5GT	.83	6SJ7GT	.41	12A8GT	.61	14N7	.84	83V	.68
1T5	.59	6AV6	.40	6SK7GT	.53	12AL5	.37	14R7	.79	84/6Z4	.46
1U4	.57	6AX4GT	.65	6SL7GT	.48	12AQ5	.52	14S7	.89	85	.59
1U5	.50	6B4	.54	6SN7GT	.59	12AT6	.41	14W7	.30	117L7	.99
1V	.43	6BA6	.49	6SQ7GT	.46	12AT7	.72	14X7	.69	117P7	.99
1X2A	.63	6BA7	.57	6SR7GT	.45	12AU6	.46	14Y7	.62	117Z3	.37
2A3	.30	6BC5	.54	6SS7GT	.42	12AU7	.60	19B6G	1.39	117Z6	.69
2W3	.38	6BD5	.59	6T4	.99	12AV6	.39	19T8	.69	807	.59
2X2	.49	6BD6	.45	6T8	.80	12AV7	.73	19V8	.79	866A	1.39
3A4	.45	6BE6	.51	6U5	.57	12AX4	.67	24A	.39	1274	.30
3B7	.27	6BF5	.41	6U6	.59	12AX7	.63	25AV5GT	.83	HI-PO	
3BC5	.54	6BF6	.37	6U8	.78	12AY7	.69	25B06GT	.98	#567	1.39
3BN6	.74	6BG6G	1.25	6V6GT	.50	12AZ7	.59	25L6GT	.51		
3CB6	.54	6BH6	.53	6W4GT	.47	12B4	.60	25W4GT	.59		
3D6	.27	6BJ6	.49	6W6GT	.57	12BA6	.49	25Z5	.66		
3E5	.46	6BK5	.80	6X4	.37	12BA7	.60	25Z6	.49		
3LF4	.69	6BK7	.80	6X5GT	.37	12BD6	.45	26	.45		
3Q4	.48	6BL7GT	.83	6X8	.75	12BE6	.51	27	.39		
3Q5GT	.69	6BN6	.74	6Y6G	.48	12BF6	.39	32L7	.89		
3S4	.58	6BQ6GT	.98	7A4	.47	12BH7	.63	35	.58		
3V4	.58	6BQ7	.90	7A5	.59	12BY7	.65	35A5	.58		
5A24	.59	6BZ7	.90	7A6	.69	12BZ7	.65	35B5	.52		
5J6	.64	6C4	.40	7A7	.69	12C8M	.34				

TERMS: A 25% deposit must accompany all orders—balance C.O.D. All shipments F.O.B. Irvington warehouse. ORDERS UNDER \$10.—\$1.00 HANDLING CHARGE . . . Subject to prior sale.

PLEASE: Send full remittance . . . allow for postage and save C.O.D. charges! We refund all unused money! Dept. RN-1.

Tubes in bold Type Cover 90% of Demand Phone: Essex 5-2947

Rad-Tel TUBE CO.

'Integrity Is Our Chief Asset'

115 COIT ST., IRVINGTON II, N. J.

TEST EQUIPMENT REPAIRED

Contractors to U. S. Government

Repairs and calibration by skilled craftsmen on all makes of Meters, Testers, Sig. Gens., V. T. V. M's, Scopes. Our nineteenth year. Low Factory prices. Stock of Genuine parts. Prompt service. All work guaranteed. Write for estimate—or ship P.P. Ins. to:

DOUGLAS INSTRUMENT LABORATORY
Electronic Instrument Repairers
176 Norfolk Avenue Boston 19, Mass.

TV TUNER REPAIRS

48-HOUR SERVICE

Defective tuners rebuilt to factory standards. New tuner guarantee. Ship prepaid.

RADIO PRODUCTS CO.
College Point 56 • New York

GET INTO ELECTRONICS



You can enter this uncrowded, interesting field. Diverse expansion, new developments demand trained specialists. Study all phases radio & electronics theory and practice; TV; FM; broadcasting; servicing; aviation, marine, police radio. 18-month course. Prepare for good pay. Graduate in demand by major companies. High School or equivalent required. Begin Jan., March, June, Sept. Campus life. Write for catalog.

VALPARAISO TECHNICAL INSTITUTE
Dept. RD Valparaiso, Indiana

STANDARD BRAND TUBES

"AT THE NEW LOW PRICES"

- Individually boxed.
- Only 1st quality
- Latest Dating—
- No private label, electrical or mechanical rejects.
- No rebrands or rewashed "bargains."
- Write for FREE 1955 new Air-Mail Handy-Order Blank.
- Lists ALL Popular TV & Radio Types.
- Makes Mail-Order a pleasure
- All tube orders over \$25.00 (with remittance) Postpaid.

SPECIAL-PURPOSE TUBES

Write for our complete listing on XMTG, Industrial, Special-Purpose and Crystal Diodes. We stock over 2,000 types at excellent prices.

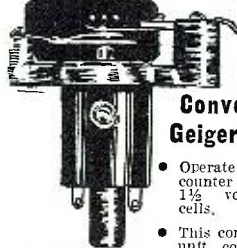

Miniature High-Voltage Converter for Geiger Counter

- Operate your geiger counter from standard 1½ volt flash-light cells.
- This compact powerful unit converts regular

battery voltage to 900 volts for direct operation of geiger counter tubes. Actual range of output is 0 to 7,000 Volts AC (easily rectified and regulated with circuits supplied) so that any type of geiger counter or photo multiplier tube can be operated from unit. Weighs only 3 ounces and small enough to fit in the palm of your hand. Unit ready to operate—factory tested.

MODEL 10MVT.....\$10.00 each
with instructions

NEW! SENSITIVE GEIGER-MUELLER COUNTER

Contains 2 subminiature tubes, Victoreen 1B85 plus hi voltage converter described above. Sensitive 4½" microammeter. Strictly a sensitive, deluxe unit. Measures 5¼" W x 7¼" H x 3" deep. Mfd. by Kaybar Mfg. Co.

in kit form.....**\$69.75**
Wired, and factory tested.....\$84.75

Victoreen Voltage Regulator VXR-130, subminiature. Brand New. Users net cost \$5. Quantity in stock.....**only 75c**

Time-Proven DIRECTRON Selenium Rectifiers now available to Radio-TV News Readers Exclusively by Barry **ONLY** Continuously Improved—Same Low Prices. Immediate Delivery. Also in stock Matched Rectifier Transformers, Chokes, & Capacitors—Write or call!

In 5 minutes you can install new type rectifier to convert 6 volt fast chargers into unit which will charge both 6 volt batteries up to 100 amps, and the new 12 volt batteries up to 50 amps. **\$24.00** (Rectifier with details only. Net. Specify make and model of battery charger.)

100 Amp (Fan Cooled) SELENIUM RECTIFIER STACK

Input: Up to 10—10 V.A.C.

Output: 7½ V.D.C.

This rectifier will handle 10 amps. convection cooled or up to 150 amps fan cooled, depending on air flow. \$11 each in lots of 3 or more. **\$11.98**

FAST CHARGER STACKS MADE TO ORDER—48 HOUR SERVICE

METEOROLOGICAL TRANSMITTER

Type T-49C. Uses RCA 3A5. Complete with tube, antenna, battery harness. Brand New.....**Only \$1.75**

SUPER SPECIAL!

3000 Volts DC—330 Ma.

BASIC COMPONENT

KW. POWER SUPPLY KIT

- 350 V. AC. XFMR @ 400 MA. Primary—115 V. 60 cy.
- 400 MA. Matched Smoothing Choke.
- 115 Volts Primary Bridge Filament for Four 556A's.

Complete **\$39.95**
Only

Also These Individual Components for Sale—Write

3,000 VOLT POCKET MULTITESTER

AC: 0-15, 150, 750, 3000 volts.
DC: 0-15, 75, 300, 750, 3000 volts.
DC MA: 0-15, 150, 750 ma.
Resistance: 0-10,000, 100,000 ohms.
Complete with battery, test leads. Only 3½" W x 4¼" H x 1¾" deep. Brand New @ **Only \$9.95**

TWO-COLORED TUBE CARTONS, with new Safety Partitions. Prevents Tube Breakage. This Super-Gloss Red and Black Carton, is the Most Distinctive Box Available Today! Minimum: 100 any one size. Quantity prices on request. Boxes F.O.B., N.Y.

SIZE	EACH
Miniature (6AUS, 6AL5, etc.)	\$.01
GT (6SN7, 6W4, etc.)	\$.0125
LARGE GT (1B3, 6BQ6GT, etc.)	.015
LARGE G (5U4G, 6BQ6G, etc.)	.02

Terms: 25% with order, balance C.O.D. All merchandise guaranteed F.O.B., N.Y.C.

NEW PHONE AND ADDRESS Phone:—WALKER 5-7000

BARRY ELECTRONICS CORP.

512 Broadway, New York 12, N.Y.

INDEX OF Advertisers

JANUARY 1955

While every precaution is taken to insure accuracy, we cannot guarantee against the possibility of an occasional change or omission in the preparation of this index.

ADVERTISER	PAGE	ADVERTISER	PAGE
Aaron Electronic Sales.....	164	Mallory & Co., Inc., P. R.	77, 4th Cover
Airex Radio Corp.	124	Mattison Television & Radio Corp.	166
Allied Radio Corp.	9	McConnell's	153
American Microphone Co.	80	McGee Radio Company.....	114, 115
American Television & Radio Co.	112	McGraw-Hill Book Co.	108
Amplifier Corp. of America.....	165	Milwaukee School of Engineering.....	86
Approved Electronic Instrument Corp.	16	Moss Electronic Distributing Co., Inc.	110, 111
Argos Products	158	Musical Masterpiece Society, Inc., The.....	169
Arky Radio Kits	153	Music-Appreciation Records	7
Arrow Electronics	128	National Electronics of Cleveland.....	130
Arrow Sales, Incorporated.....	137	National Radio Institute.....	3, 19, 20
Ashe Radio Co., Walter.....	30	National Schools	81
Audel Publishers	169	Newcomb	125
Baltimore Technical Institute.....	173	Olson Radio Warehouse.....	123
Barry Electronics Corp.	172	Orradio Industries, Inc.	15
Bell Telephone Laboratories.....	75	Palley Supply Co.	124
Boland & Boyce, Inc.	24	Peak Electronics Co.	162
Burstein-Applebee Co.	153	Permoflux Corp.	26
CBS-Hytron	32	Pickering & Company, Incorporated.....	12
Candler System Co.	170	Platt Electronics Corp.	116
Cannon Electric Co.	165	Precision Radiation Instruments.....	164
Capitol Radio Engineering Institute.....	27	Premier TV Radio Supply.....	101
Centralab	34, 35	Progressive "Edu-Kits," Inc.	131
Channel Master Corp.	102, 103	RCA Institutes, Inc.	31, 170
Cleveland Institute of Radio Electronics	117, 118	RCA Service Company, Inc.	148
Columbia Electronics	170	RW Electronics.....	149
Commissioned Electronics Co.	168	Radiart Corp.	3rd Cover
Concord Radio	157	Radio Corporation of America.....	14, 141
Corona Radio & TV Co.	161	Radion Corporation, The.....	152
Coyne Electrical School.....	135, 167	Radio Products Co.	171
DeVry Technical Institute.....	5	Radio-Television Training Association.....	25
Douglas Instrument Laboratory.....	171	Rad-Tel Tube Co.	171
Drilliek Electronic Sales Co.	164	Raytheon Manufacturing Co.....	2nd Cover
Editors & Engineers, Ltd.	130	Regency	108
Electric Soldering Iron Co.	156	Rider Publisher, Inc., John F.	138
Electronic Chemical Corp.	159	Rinehart & Company, Inc.	22, 23
Electronic Instrument Co., Inc. (EICO)	36, 100, 128, 131	Sams & Co., Inc., Howard W.	146
Electron Tube Wholesalers, Inc.	173	Sam's Surplus	155
Electro-Voice	8	Seco Mfg. Co.	160
Fair Radio Sales.....	151	Sherwood Electronic Laboratories.....	154
Fisher Radio Corp.	82, 83, 84, 85	Simpson Electric Company.....	10, 11
G & G Radio Supply Co.	140	Sleeper, Milton B., Publisher.....	129
G & H Wood Products Co.	132, 133	Sonotone Corporation	119
General Cement Mfg. Co.	142, 143	Sprague Products Company.....	17
General Electronic Distributing Co.....	127, 153	Sprayberry Academy of Radio.....	13
Goodheart, R. E.	161	Stan Burn Radio & Electronics Co.	152
Grantham School of Electronics.....	170	Standard Surplus	145
Greenlee Tool Co.	167	Steve-El Electronics Corp.	148
Hallcrafters	122, 124, 126	Stuart Electronics Distributors.....	147
Harjo Sales Co.	156	Sun Parts Distributors, Ltd.	146
Harmon-Kardon, Inc.	79	Supreme Publications	163
Harvey Radio Company.....	160	Sylvania Electric Products, Inc.	21
Heath Company	87, 88, 89, 90, 91, 92, 93, 94, 95, 96, 97, 98	"TAB"	174
Henshaw Radio Supply.....	168	Tech-Master Corporation	100
Hickok Electrical Instrument Co.	134	Tele-Test Instrument Corp.	157
Hughes Research and Development Laboratories	139, 156	Teltron Electric Company.....	161
Indiana Technical College.....	168	Terado Company	136
Institute of Radio Engineers.....	144	Terminal Radio Corp.	135
JFD Manufacturing Co., Inc.	105	Transamerica Electronics Corp.	113
J. J. Glass Electronics Co.	161	Transvision, Inc.	104, 170
J. S. H. Sales Co.	100	Tri-State College	166
Jones & Laughlin Steel Corporation.....	18	Tung-Sol Electric, Inc.	99
Kay-Townes Antenna Company.....	106, 107	U. S. Crystals, Inc.	168
Kuhn Electronics	173	Ungar Electric Tools, Inc.	148
Lafayette Radio	28	United Transformer Co.	29
Lampkin Laboratories, Inc.	167	University Loudspeakers, Inc.	147
Leonard Radio, Inc.	146	Valparaiso Technical Institute.....	171
Leotone Radio Corp.	169	Van Nostrand, Company, Inc., D.	150
Liberty Electronics, Inc.	128	Walco	152
Magnecord, Inc.	109	Walsco Electronics Corporation.....	33
		Wescott Tape	170
		Western Television Institute.....	165
		Wholesale Radio Parts Co., Inc.	160
		Winegard Company	6
		World Radio Laboratories.....	159
		Zingo Products	168

Classified

Rate 50c per word. Minimum 10 words

RADIO ENGINEERING

COMPLETE radio, electronics theory & practice; television; broadcasting; servicing; aviation, marine, police radio, 12 or 18 months. Catalog. Valparaiso Technical Institute, Dept. N, Valparaiso, Ind.

FOR SALE

Hi-Fidelity Bargains—Brand new, factory packed. Collaro 3-532, dual supplies, 45 spindle—\$36.95. GE RPX-050—\$3.95. University 6201 Coax—\$38.85. Prepaid. Tuners, Amplifiers, Speakers, Turntables, Baffles, Changers, etc. All Low Priced, Unpaid, Brand New—Write Today. Fidelity Unlimited, 63-03 39 Ave., Woodside, N. Y.

SAMPLE "Parasite" Bowtie Antenna \$1.25. Material for assembling 80 antennas \$32.50. Individual Sam's Schematics rented; sold; lowest rates. Cassidy—4369 Neosho—St. Louis, Missouri.

Hi-Fi Fans: Complete new stocks of Stephens, J. Lansing, Fisher, Altec-Lansing, Pilot, Garrard, Thorens, etc. Demonstrators, net less 25% without trade-in! Write, wire, or telephone—anytime! Telco #1 Azurete Dr., Malibu, Calif. Tel.: Globe 6-2611.

SURPLUS Transmitters, BC 457, used complete with tubes, \$3.50 each. C.O.D. Plus Postage, Rogers Trading Co., 2325 Second Ave., N. Birmingham 3, Ala.

TELEVISION Receivers, working, \$30 up. Repairable, \$10. W.I.A.P. 1420 South Randolph, Arlington 4, Virginia.

ALUMINUM Tubing. Angle and Channel, Plain and Perforated Sheet. Willard Radcliff, Fostoria, Ohio.

TUBES—70% to 90% Discount. Government, manufacturers, jobbers, etc., surplus. Guaranteed 1 year. Free catalog on request. Cadillac Trading, Dept. AD, 231-07 Linden Blvd., Jamaica 11, N. Y.

FREE: Get our monthly electronic lists. Dick Rose, Everett, Wash.

FORTY Complete VHF Radio Terminals. These are designed for telephone service in the 72-76 mc. band, and are ideal for setting up a communication system along a pipeline, railroad, or in mountainous or bush country. Each terminal consists of the following: 1—Link Radio Type 1498T Transmitter; 1—Link Radio Type 1198P Power Supply; 1—Link Radio Type 1498R Receiver; 1—Budelman 200 watt Power Amplifier; 1—Type PP13 Power Supply; 1—Federal Type 101B V-F Ringer 500 ft.—Type RG 8U Coaxial Cable, 2—Welded steel Yagi Antennas—5 element; 1—Lister Diesel-Generator set, 2 KW. P. J. Plisher, 550—Fifth Avenue, New York City.

DIAGRAMS—Radio \$1.00; record changers, recorders \$1.25. Television with service data \$2.00. Where model unknown, give part numbers. Kramer's Radio Service, Dept. S53, 36 Columbus Ave., New York 23, N. Y.

TAPE Recorders, Tapes, Accessories. Unusual Values. Dressner, Box 66R, Peter Stuyvesant Station, N. Y. 9.

TUBES and equipment bought, sold, and exchanged. For action and a fair deal write B. N. Gensler, W2LXI, 136F Liberty, N. Y. 6, N. Y.

AN/APR-4, other "APR," "ARR," "TS," "HB," "ARC-1, ARC-3, ART-13, everything surplus; Tubes, Manuals, Laboratory equipment. Describe, price in first letter. Engineering Associates, 434 Patterson Rd., Dayton 9, Ohio.

TV Test Equipment—Sweep Gen. GE ST4A \$250 Marker Gen. GE ST5A \$300 Lin. Pat. Gen. Hickok 620 \$50 VTYM Syly. 134 \$25 Tube Test. Precision 954G \$35. Marine Radio Box 5155, Jacksonville, Fla.

REPAIR Shop (Radio-Appliance) with Apartment. Some Merchandise. Established 11 yrs. Owner: 2012 De la Vina St., Santa Barbara, California.

SOUND-OFF! Build fully automatic electronic brain. The Musicron cuts out commercials. Lets any radio, TV play only music! Pricedless possession for home, business, office. Simple, low-cost construction. 2-tubes. Handsome booklet, schematic, full instructions Plus special component, \$3.50 with order. Free literature. Norman Electronics Company, P. O. Box 733, Brooklyn 1, N. Y.

TELEVISION sets \$18 up. Jones, 1115 Rambler Ave., Pottstown, Pa.

FIFTEEN Assorted—Resistors, Condensers, Knobs, 30c. Trowbridge, 312 West 75th, Chicago 21.

TV-FM antennas. All types including UHF. Mounts, Accessories. Lowest prices. Wholesale Supply Co., Dept. H, Lunenburg, Mass.

WANTED

TOP Dollar Paid for Art-13's, dynamotors, parts racks and all other component parts. Write: Harjo Sales Co., 4109 Burbank Blvd., Burbank, Calif.

WANTED: Type R19/TRC-1 Receivers. Box 543, Radio & Television News.

WANTED: BC-348R, R5/ARN-7, T-47A/ART-13, CU-25/ART-13, BC-653, CU-32/ART-13, DY-17. Send full list of what you have. Top Dollar Paid. Radalab 87-17 124 Street, Richmond Hill 18, New York.

BUSINESS OPPORTUNITIES

BUY Wholesale—25,000 items—Catalog 25¢. Matthews. 1472-R5, Broadway, NYC 36.

CORRESPONDENCE COURSES

USED Correspondence Courses, Books Bought, Sold, Rented. Catalog Free. Educational Exchange, Summerville, Ga.

USED correspondence Courses and Books sold and rented. Money back guarantee. Catalog free. (Courses bought.) Lee Mountain, Pisgah, Ala.

HELP WANTED

TELEVISION Jobs—Names and addresses of companies to contact. \$1.00. Fitzgerald, Dept. A-14, 3038 West Wellington Avenue, Chicago 18, Illinois.

MISCELLANEOUS

MC'S Speaker Reeking. Low prices, 506 N. Ward Street, Benton, Illinois.

ALL makes speakers repaired. Amprite Speaker Service, 70 Vesey St., New York City 7.

200 UNMARKED ceramicoms. Mixed values \$1.00. Schneider, Box 214, Seaford, N. Y.

RECORDING Fans: Swap tape everywhere. De-tails Free. Box 1404-G, San Francisco 1.

TOP QUALITY TUBES ONE YEAR GUARANTEE

BELOW MFRS' PRICES!

A WORD TO THE WISE: "JUNK is the MOST EXPENSIVE Thing You Can Buy!"

Junk is NEVER a Bargain . . . Price alone is not enough . . . a REAL Bargain is a combination of Price AND Quality: LOW Price and HIGH Quality! On the basis of QUALITY and DEPENDABILITY, Electron Tube Wholesalers offer the LOWEST TUBE PRICES on the market today!

We want your business now, of course. We also want it for the future. That's why we make absolutely certain that every tube shipped has first been carefully tested in our laboratories, for optimum performance. And we guarantee every ELECTRON Tube, NOT for THREE Months—NOT for SIX Months—but for ONE FULL YEAR! As Tube Specialists for many years, we carry one of the Largest Tube Stocks in the whole wide world—more than 2000 different types—Receiving, Transmitting, Special Purpose—all in stock in substantial quantities, for IMMEDIATE DELIVERY. ALL ELECTRON Tubes individually boxed in handsome three-color cartons.

Type	Price	Type	Price	Type	Price	Type	Price
OB2	.79	6AC5GT	.99	6J6	.59	12K8	.58
OB3/VR90	.98	6AC7	.79	6K6GT	.45	12Q7GT	.59
OC3/VR105	.98	6AF4	.89	6K6GT	.45	12SA7GT	.64
OD3/VR150	.89	6AF6	.75	6K7	.35	12S57	.59
OD5	.54	6AG7	.95	6K8	.65	12SF5	.49
IA5GT	.43	6AG7	.95	6L7	.59	12S67	.75
IA7	.53	6AH6	.89	6N7	.98	12S7GT	.49
IAZ2	.59	6AJ5	.89	6P7	.49	12S87	.49
IB3	.59	6AK5	.79	6Q4	.59	12A7	.68
1D8GT	.77	6AL5	.33	6S7G	.59	12A7	.68
1G4	.49	6AL7	.89	6S7G	.59	12A8	.63
1G6GT	.43	6AM8	.69	6S7G	.59	12AV6	.53
1J6G	.59	6AN8	.79	6S7G	.59	12AV7	.72
1L4	.49	6AQ5	.39	6S7G	.59	12AV7	.72
1L4A	.59	6AR5	.45	6S7G	.59	12AX4GT	.68
1LA6	.79	6AS5	.48	6S7G	.59	12AX7	.63
1LB4	.79	6AT6	.41	6S7G	.59	12AY7	.89
1LC5	.59	6AT6	.41	6S7G	.59		
1LD5	.52	6AUG	.46	6S7G	.59		
1LE3	.78	6AV6	.34	6S7G	.59		
1LN5	.57	6AX4GT	.59	6S7G	.59		
1PSGT	.56	6B7	.95	6S7G	.59		
1QSGT	.54	6BB6	.53	6S7G	.59		
1S4	.58	6BA6	.39	6S7G	.59		
1S5	.45	6BA7	.56	6S7G	.59		
1S7	.45	6BC5	.54	6S7G	.59		
1U4	.39	6BE6	.39	6S7G	.59		
1V	.69	6BG6	1.24	6S7G	.59		
1V2	.50	6BH6	.49	6S7G	.59		
1X2A	.59	6BK5	.69	6S7G	.59		
2A3	.95	6BK7A	.72	6S7G	.59		
2A6	.64	6BL7GT	.89	6S7G	.59		
2A7	.64	6BN6	.69	6S7G	.59		
2B7	.62	6BR6	.95	6S7G	.59		
2K2	.39	6BQ7A	.92	6S7G	.59		
2X2A	1.85	6BZ7	.92	6S7G	.59		
3A4	.44	6C5	.39	6S7G	.59		
3A5	.90	6C6G	.57	6S7G	.59		
3AB	.60	6C8	.41	6S7G	.59		
3B7	.39	6C8	.41	6S7G	.59		
3L4	.39	6C9	.45	6S7G	.59		
3Q4	.55	6D6	.99	6S7G	.59		
3Q5GT	.69	6CF6	.64	6S7G	.59		
3S4	.56	6CG6	.69	6S7G	.59		
3V4	.58	6D6	.99	6S7G	.59		
5T4	1.28	6D6	.99	6S7G	.59		
5U4	.55	6D6	.99	6S7G	.59		
5Y4	.39	6D6	.99	6S7G	.59		
5Y3GT	.39	6D6	.99	6S7G	.59		
5Z3	.44	6D6	.99	6S7G	.59		
6A3	.89	6D6	.99	6S7G	.59		
6A6	.51	6D6	.99	6S7G	.59		
6A8	.69	6D6	.99	6S7G	.59		
6A84	.69	6D6	.99	6S7G	.59		
6B7	.75	6D6	.99	6S7G	.59		

THIS MONTH'S SPECIALS

Our new policy brings you greater tube savings than you thought possible! As a GOODWILL offering, we are giving, each month, a number of popular tube types (listed in section header) AT PRICES BELOW OUR OWN COST! Look for these terrific offers of different types each month, in industry-wide publications!

6S7GT	.49	7B6	.59	12B6	.49
6S7H	.60	7C4	.58	12BA6	.49
6S7HT	.50	7C5	.49	12BA7	.59
6S7J	.50	7C7	.49	12BD6	.49
6S7K	.50	7E5	.59	12BE6	.59
6S7L	.59	7F5	.59	12BH7	.39
6S7M	.59	7G7	.59	12B7	.59
6S7N	.49	7H7	.59	12BY7	.69
6S7P	.49	7J7	.75	12C8	.65
6S7Q	.49	7L7	.59	12D8	.49
6S7R	.45	7M7	.85	12E5GT	.35
6S7S	.60	7N7	.85	12H6	.45
6S7T	.60	7P7	.70	12J6GT	.45
6S7U	.79	7Q7	.44	12K7GT	.58
6S7V	.79	7R7	.49	12K7	.55
6S7W	.45	7T7	.49		
6S7X	.45	7U7	.49		
6S7Y	.45	7V7	.49		
6S7Z	.45	7W7	.49		
6S7AA	.45	7X7	.49		
6S7AB	.45	7Y7	.49		
6S7AC	.45	7Z7	.49		

6S7AD	.45	7AA7	.49
6S7AE	.45	7AB7	.49
6S7AF	.45	7AC7	.49
6S7AG	.45	7AD7	.49
6S7AH	.45	7AE7	.49
6S7AI	.45	7AF7	.49
6S7AJ	.45	7AG7	.49
6S7AK	.45	7AH7	.49
6S7AL	.45	7AI7	.49
6S7AM	.45	7AJ7	.49
6S7AN	.45	7AK7	.49
6S7AO	.45	7AL7	.49
6S7AP	.45	7AM7	.49
6S7AQ	.45	7AN7	.49
6S7AR	.45	7AO7	.49
6S7AS	.45	7AP7	.49
6S7AT	.45	7AQ7	.49
6S7AU	.45	7AR7	.49
6S7AV	.45	7AS7	.49
6S7AW	.45	7AT7	.49
6S7AX	.45	7AU7	.49
6S7AY	.45	7AV7	.49
6S7AZ	.45	7AW7	.49
6S7BA	.45	7AX7	.49
6S7BB	.45	7AY7	.49
6S7BC	.45	7AZ7	.49
6S7BD	.45	7BA7	.49
6S7BE	.45	7BB7	.49
6S7BF	.45	7BC7	.49
6S7BG	.45	7BD7	.49
6S7BH	.45	7BE7	.49
6S7BI	.45	7BF7	.49
6S7BJ	.45	7BG7	.49
6S7BK	.45	7BH7	.49
6S7BL	.45	7BI7	.49
6S7BM	.45	7BJ7	.49
6S7BN	.45	7BK7	.49
6S7BO	.45	7BL7	.49
6S7BP	.45	7BM7	.49
6S7BQ	.45	7BN7	.49
6S7BR	.45	7BO7	.49
6S7BS	.45	7BP7	.49
6S7BT	.45	7BQ7	.49
6S7BU	.45	7BR7	.49
6S7BV	.45	7BS7	.49
6S7BW	.45	7BT7	.49
6S7BX	.45	7BU7	.49
6S7BY	.45	7BV7	.49
6S7BZ	.45	7BW7	.49
6S7CA	.45	7BX7	.49
6S7CB	.45	7BY7	.49
6S7CC	.45	7BZ7	.49
6S7CD	.45	7CA7	.49
6S7CE	.45	7CB7	.49
6S7CF	.45	7CC7	.49
6S7CG	.45	7CD7	.49
6S7CH	.45	7CE7	.49
6S7CI	.45	7CF7	.49
6S7CJ	.45	7CG7	.49
6S7CK	.45	7CH7	.49
6S7CL	.45	7CI7	.49
6S7CM	.45	7CJ7	.49
6S7CN	.45	7CK7	.49
6S7CO	.45	7CL7	.49
6S7CP	.45	7CM7	.49
6S7CQ	.45	7CN7	.49
6S7CR	.45	7CO7	.49
6S7CS	.45	7CP7	.49
6S7CT	.45	7CQ7	.49
6S7CU	.45	7CR7	.49
6S7CV	.45	7CS7	.49
6S7CW	.45	7CT7	.49
6S7CX	.45	7CU7	.49
6S7CY	.45	7CV7	.49
6S7CZ	.45	7CW7	.49
6S7DA	.45	7CX7	.49
6S7DB	.45	7CY7	.49
6S7DC	.45		

the most complete line...

a model for every application

C·D·R ROTORS

C·D·R Rotors have

AXS 679*

**The highest grade premium die cast aluminum... so rugged and durable that it is used for aircraft landing gear.*

PRE-SOLD

for you to MILLIONS
through spot announce-
ments on television.

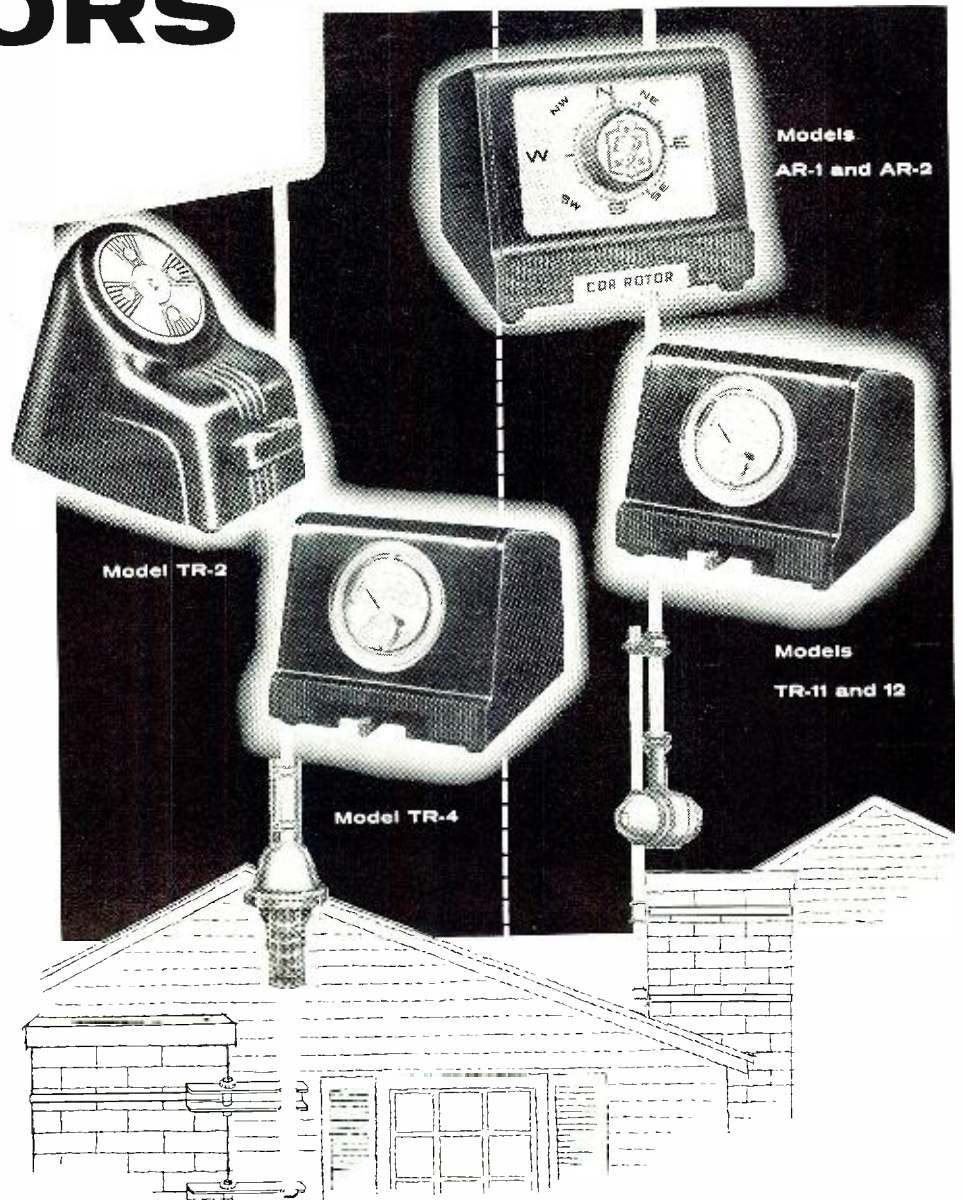

CORNELL-DUBILIER
SOUTH PLAINFIELD, N. J.



THE RADIART CORP.
CLEVELAND 13, OHIO

P. R. MALLORY & CO. INC.
MALLORY
APPROVED PRECISION PRODUCTS

P. R. MALLORY & CO. INC.
MALLORY
APPROVED PRECISION PRODUCTS

P. R. MALLORY & CO. INC.
MALLORY
APPROVED PRECISION PRODUCTS



On electrolytics— FP means MALLORY!

Look for the two names—Mallory and FP—on the electrolytic capacitors you buy. They're your assurance of getting the genuine FP design, offering an exclusive combination of Mallory-developed features.

Famous for long life on the shelf and in service, they have true fabricated plate anodes... have been built for years to operate dependably at 85° C (185° F).

FP's handle high ripple currents. They're ideal for voltage doubler applications and for selenium rectifier circuits. Their twist prong mounting cuts installation time to seconds.

Don't accept substitutes. Always specify *Mallory FP Capacitors* to be sure of premium performance at no extra price.

BE SURE TO USE . . .



*Mallory Plascaps** . . . plastic tubular replacements with permanently secured leads . . . won't short out or open prematurely.



*Subminiature Silverlytic** Capacitors . . . only $\frac{3}{8}$ " long and $\frac{1}{32}$ " in diameter . . . ideal for transistors and other miniature low-voltage circuits.

*Trademark

P. R. MALLORY & CO. INC.
MALLORY
APPROVED PRECISION PRODUCTS

P. R. MALLORY & CO. INC.
MALLORY
CAPACITORS • CONTROLS • VIBRATORS • SWITCHES • RESISTORS
RECTIFIERS • POWER SUPPLIES • FILTERS • MERCURY BATTERIES
APPROVED PRECISION PRODUCTS
P. R. MALLORY & CO. Inc., INDIANAPOLIS 6, INDIANA

P. R. MALLORY & CO. INC.
MALLORY
APPROVED PRECISION PRODUCTS

P. R. MALLORY & CO. INC.
MALLORY
APPROVED PRECISION PRODUCTS

P. R. MALLORY & CO. INC.
MALLORY
APPROVED PRECISION PRODUCTS